

INSTRUCTION MANUAL FOR

STAINLESS
STEEL



CALIBER
.45ACP

RUGER® P97DC

DECOCKER MODEL PISTOLS*



*DO NOT USE THIS MANUAL FOR PISTOLS EQUIPPED WITH
MANUAL SAFETIES OR "DOUBLE ACTION ONLY" PISTOLS



**READ THE INSTRUCTIONS AND
WARNINGS IN THIS MANUAL CAREFULLY
BEFORE USING THIS FIREARM**

**For Product Service on This Model Please Call:
(520) 778-6555 (See p. 21)**

**STURM, RUGER & Company, Inc.
Southport, Connecticut 06490 U.S.A.**

THIS INSTRUCTION MANUAL SHOULD ALWAYS ACCOMPANY THIS FIREARM AND BE
TRANSFERRED WITH IT UPON CHANGE OF OWNERSHIP, OR WHEN THE FIREARM IS LOANED
OR PRESENTED TO ANOTHER PERSON

V & KV (P97DC)
1/99

FIREARMS SAFETY - YOUR RESPONSIBILITY

SAFETY MUST BE THE FIRST AND CONSTANT CONSIDERATION OF EVERY PERSON WHO HANDLES FIREARMS AND AMMUNITION.

This Instruction Manual is designed to assist you in learning how to use and care for your **RUGER® P97** Decocker Model Pistols properly. Please contact us if you have any questions.

Only when you are certain you fully understand the Manual and can properly carry out its instructions should you practice loading, unloading, etc., with live ammunition. If you have any doubts about your ability to handle or use a particular type of gun safely, you should seek supervised instruction. Such personalized instruction is often available from gun dealers, gun clubs or police departments. If none of these sources can help you, write to the National Rifle Association, 11250 Waples Mill Road, Fairfax, VA 22030-7400. They will assist you.

The person possessing a gun has a full-time job. You cannot guess; you cannot forget. You must know how to use your firearm safely. **Do not use any firearm without having a complete understanding of its particular characteristics and safe use.** Remember: There is no such thing as a foolproof gun.

TABLE OF CONTENTS

General Information and Mechanical Characteristics	3
Special Feature - Decocking Lever	6
Ammunition	8
To Load and Fire (with magazine)	9
To Uncock (Decock) The Pistol	10
To Load and Fire (without magazine)	11
To Unload	12
To Reload The Pistol	14
To Extract and Eject a Chambered Cartridge	14
To Clear a Malfunction ("Jam")	15
To Minimize Malfunctions ("Jams")	15
To Disassemble	16
To Reassemble	18
Magazine Inspection and Care	18
Care and Cleaning	19
Sight Adjustment	20
Service and Parts Policy	21
Parts Drawings	26
The Basic Rules of Safe Firearms Handling	27
Warranty Information	32

Ruger® is a registered U.S. trademark.

 WARNINGS OF GREAT IMPORTANCE ARE FOUND ON THE FOLLOWING PAGES:			
Alterations	3	Unloading	12
Lockable Storage Boxes	5	Slide Retraction	13
Decocking Lever	7	Malfunctions	15
Lead Exposure	7	Disassembly	16
Ammunition	8	Lubrication	20
Firing	10	Storage	20
Handling	11	Parts Purchasers	22
OTHER CAUTIONS AND WARNINGS APPEAR THROUGHOUT THE MANUAL.			

FIREARMS ARE DANGEROUS WEAPONS - READ THE INSTRUCTIONS AND WARNINGS IN THIS MANUAL THOROUGHLY AND CAREFULLY BEFORE USING.

 WARNING - ALTERATIONS	
	This product was designed to function properly in its original condition. Alterations can make it unsafe. Do not alter any part or add or substitute parts or accessories not made by Sturm, Ruger & Co. Inc.
DO NOT ALTER ANY GUN	

GENERAL INFORMATION AND MECHANICAL CHARACTERISTICS

The **RUGER® P97DC** pistols are centerfire, double action, "decock only" magazine-fed, autoloading, recoil-operated pistols chambered for the caliber .45ACP cartridge. They incorporate a different "linkless" design in the barrel locking/unlocking system than earlier Ruger P-Series pistols, and feature a streamlined slide and Isoplast® polymer grip frame construction. They comply with the requirements of the National Institute of Justice Standard-0112.00. They include the following features with which users should be thoroughly familiar:

NOMENCLATURE

Sights have high-visibility white dots both front and rear. Rear sights can be adjusted for windage.

Slide's open top design minimizes possibility of jamming, enables shooter to clear any malfunction easily by hand. Cartridges can be loaded singly if desired.

Grooved, exposed **hammer** spur enables the shooter to cock the hammer easily for single-action firing if desired.

To decock the pistol, depress the decocking lever until the hammer drops. This action moves the firing pin forward into the slide. This temporarily places the firing pin out of reach of the hammer stroke and locks the firing pin in a neutral position, preventing it from moving toward the cartridge.

RELEASING EITHER DECOCK LEVER WILL ALLOW THE LEVERS TO SPRING UPWARD TO THEIR ORIGINAL POSITION, PLACING THE PISTOL IN A READY TO FIRE CONDITION.

Frame is a rigid one piece polyurethane grip frame reinforced with long glass fiber.

Double-action mechanism and strongly curved **trigger** provide that cocking and firing can be accomplished with a single pull of the trigger.

Oversize **trigger guard** permits shooting with gloved hand. Recurved trigger guard bow accommodates non-shooting hand in two-hand hold.

The **magazine latch** permits positive retention and quick removal of magazine.

Slide stop holds the slide open and is activated automatically when last shot is fired (if magazine is in pistol), or can be manually operated.

Action: The action of the Ruger P97 decocker model pistols is of the type that utilizes a tilting barrel design in which the barrel and slide are locked together at the moment of firing. After firing, the barrel and slide recoil to the rear a short distance while still locked together. After this initial movement, the barrel is cammed downward from its locked position, permitting full recoil of the slide and the extraction and ejection of the spent cartridge case. Upon return of the slide to its forward position by the recoil spring, the barrel is cammed back upward into its locked position in the slide.

The user of this or any autoloading pistol must always remember that when fired, it automatically reloads and recocks itself, so that simply pulling the trigger will fire the pistol again. Therefore, an autoloading pistol user must be particularly conscious to always keep the pistol pointed in a safe direction.

Slide Stop: When the last shot has been fired and the magazine is empty, the slide stop automatically holds the slide open. When there is an empty magazine in the pistol and the slide is retracted manually, the slide stop will also automatically hold the slide open. If a loaded magazine is inserted in the pistol when the slide is closed and the slide is then retracted fully, the slide stop will not automatically hold open the slide. The user can actuate the slide stop mechanism to hold the slide open at any time by retracting the slide and pushing the slide stop up.

The slide stop can be released by drawing back slightly on the slide and depressing the slide stop thumbpiece. When the slide is released, it will move forward under pressure from the recoil spring.

The slide stop is held in place by a spring detent. Therefore, when there is a loaded magazine in place and the pistol is jarred, the slide can fly forward and chamber a cartridge. For this reason and as an essential safety practice, **the user should always be careful to keep fingers away from the trigger and always keep the pistol pointed in a safe direction.**

Magazines: Ruger .45ACP magazines are not interchangeable with Ruger pistol magazines of any other caliber. Use of incorrect magazines in any pistol will result in malfunctions. The **RUGER® P97DC** comes equipped with 8 round capacity magazines. The 8 round magazine is identified by its' stainless steel follower, which is visible at the top of the magazine when it is empty. The **RUGER® P97DC** will also function correctly with Ruger 7 round .45 ACP magazines. These 7 round magazines use a black plastic follower, also visible at the top of the magazine when it is empty. Ruger .45ACP magazines are unmarked as to caliber. All other Ruger centerfire magazines, which are similar in appearance, are marked as to caliber (".40 Auto Cal.," etc.)

DAMAGED, NON-STANDARD, OR IMPROPERLY ASSEMBLED MAGAZINES SHOULD NOT BE USED. THEY CAN CAUSE THE PISTOL TO MALFUNCTION.

WARNING – LOCKABLE STORAGE BOXES



DON'T LEAVE KEYS IN THE LOCK

All Ruger pistols and revolvers are originally sold in a lockable box, with a key-operated padlock. While it can help provide secure storage for your **unloaded** firearm, any locking device can fail. The ultimate responsibility for secure storage must depend upon its owner and his or her individual circumstances. Always store firearms securely, unloaded, in a secure location, separate from their ammunition.

Never leave the keys in the lock. See "Storage Warning", p. 20.

ALWAYS STORE FIREARMS SECURELY

SPECIAL FEATURE - DECOCKING LEVER

The model you have selected is equipped with a special manual decocking lever that also allows you to decock (uncock) a cocked pistol without manipulating the trigger. Conventional thumb decocking procedures are therefore not necessary and should not be employed with this pistol.

To decock the pistol, **point the pistol in a safe direction.** Depress the decocking lever until the hammer drops. The decocking lever first moves the firing pin into the slide far enough so that the rear end of the firing pin cannot be struck by the hammer. Only then will continued depression of the decocking lever safely drop the hammer to an uncocked position (see Figure 1). To return the pistol to firing condition, simply release the decocking lever (see Figure 2). It will spring upward to its original position. The pistol is then ready to fire by a "double-action" pull of the trigger. The hammer can also be manually cocked immediately before shooting a "single-action" firing. The trigger pull is both shorter and relatively lighter in the "single-action" mode, which is preferred for more accurate shooting.

Additionally, the pistol has a separate internal firing pin block that will not allow the firing pin to move forward until the operator pulls the trigger.

Never carry or holster the pistol with the hammer cocked, as a relatively light pull of the trigger will fire the pistol. When not actually shooting, always immediately decock (uncock) the pistol by use of the decocking lever.

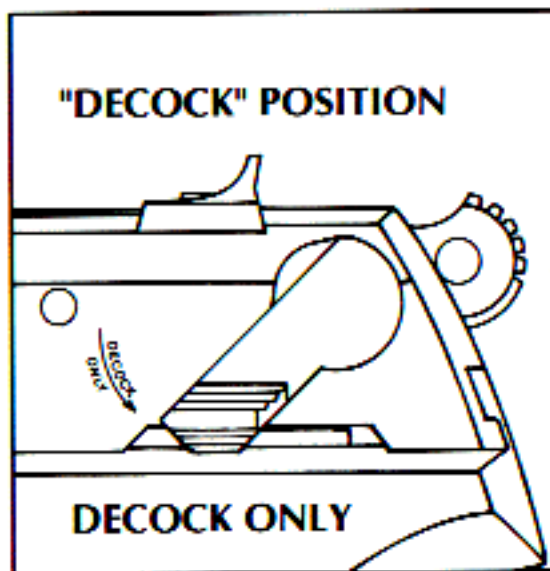

FIGURE 1

The decock lever will only attain this position when held down by the user. This decocks the pistol.

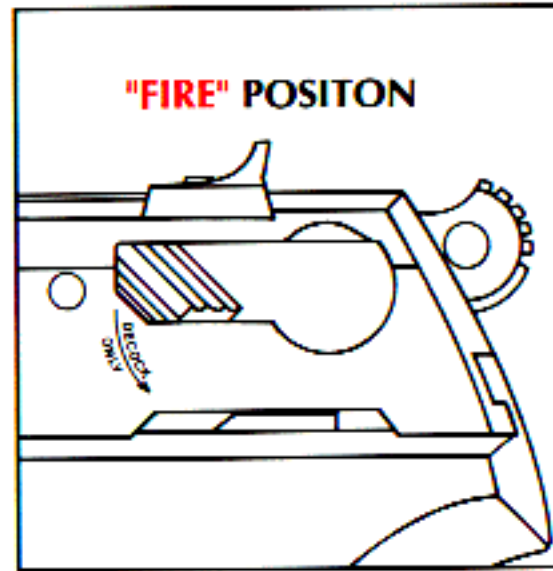

FIGURE 2

The decock lever will **automatically** spring back to this firing position **when released.**

! WARNING - DECOCKING LEVER	
<p>"DECOCK" POSITION WHEN HELD</p> <p>DECOCK ONLY</p> <p>"FIRE" POSITION WHEN RELEASED</p>	<p>Operating the decocking lever does <u>not</u> prevent firing when the trigger is pulled. Like a double-action revolver, the pistol will fire whenever the trigger is pulled. Therefore, never touch the trigger, whether the pistol is cocked or not, unless you wish to fire the pistol. Do not decock the pistol manually - always use the decocking lever.</p>
DECOCKING LEVER AUTOMATICALLY RETURNS TO "FIRE" POSITION WHEN RELEASED	

! WARNING - LEAD EXPOSURE	
	<p>Discharging firearms in poorly ventilated areas, cleaning firearms, or handling ammunition may result in exposure to lead and other substances known to the state of California to cause birth defects, reproductive harm, and other serious physical injury. Have adequate ventilation at all times. Wash hands thoroughly after exposure.</p>
SHOOTING OR CLEANING GUNS MAY EXPOSE YOU TO LEAD	

AMMUNITION

The **RUGER® P97DC** pistols are chambered for the .45ACP cartridge. Do not attempt to load any other cartridges into the magazine or chamber of the pistol.

The Ruger P-Series pistols are compatible with all factory ammunition loaded to U.S. Industry Standards, including high-velocity and hollow-point loads, loaded in brass, aluminum, or steel cartridge cases. No .45ACP ammunition manufactured in accordance with NATO, U.S., SAAMI, or CIP standards is known to be beyond the design limits or known not to function in these pistols.

USE ONLY FACTORY AMMUNITION LOADED TO U.S. INDUSTRY STANDARDS

⚠ WARNING - AMMUNITION	
	Death, serious injury, and damage can result from the use of the wrong ammunition, bore obstructions, powder overloads, or incorrect cartridge components. Even the strongest gun can be "blown up" as a result of excess pressure. Always wear shooting glasses and hearing protection.
IMPROPER AMMUNITION DESTROYS GUNS	

AMMUNITION (CARTRIDGES) NOTICE

WE SPECIFICALLY DISCLAIM RESPONSIBILITY FOR ANY DAMAGE OR INJURY WHATSOEVER OCCURRING IN CONNECTION WITH, OR AS A RESULT OF, THE USE IN RUGER FIREARMS OF FAULTY, OR NON-STANDARD, OR "RE-MANUFACTURED", OR HAND-LOADED (RELOADED) AMMUNITION, OR OF CARTRIDGES OTHER THAN THOSE FOR WHICH THE FIREARM WAS ORIGINALLY CHAMBERED.

TO LOAD AND FIRE (WITH MAGAZINE)

Practice this important aspect of safe gun handling with an unloaded pistol until you can perform each of the steps described below with skill and confidence. **But before you do anything with the pistol, first read completely through this manual.**

1. **Keep the muzzle pointed in a safe direction.** (See "The Basic Rules of Safe Firearms Handling," page 27.)
2. Press the magazine latch inward from the left side, and remove the magazine from the frame. **NOTE:** The magazine is designed to fall free of the frame of its own weight when unloaded and the pistol is held in the normal firing position, but you should always prevent possible damage to the magazine by not letting it drop to the ground unless rapid reloading is absolutely necessary.
3. Place eight (8) or fewer .45ACP cartridges into an 8 round magazine, or seven (7) or fewer .45ACP cartridges into a 7 round magazine (see p. 5 for magazine identification).
4. Insert the magazine into the frame, taking care that the magazine is locked in place by the magazine latch. Slamming the magazine into the frame forcibly is not necessary.
5. Hold the pistol firmly in the shooting hand but **do not touch the trigger.** **Keep the pistol pointed in a safe direction.** With the thumb and forefinger of the other hand grasp the rear of the slide and pull the slide to the rear as far as it will go (See "Slide Retraction Warning" p. 13). When released, the slide will fly forward to strip the top cartridge from the magazine and chamber it. **WARNING:** The pistol is ready for instant use in the single-action mode once the slide moves forward. Be careful!
6. If the pistol is not to be fired immediately, keep it pointed in a safe direction and depress the decocking lever until the hammer drops. Remember that the decocking lever will spring back to the double-action "fire" position when released. (See Decocking Lever Warning", p. 7)
7. When the pistol is in the "uncocked" mode (hammer forward), the first shot can be fired double-action by pulling the trigger all the way to the rear, which cocks the hammer and then fires the pistol. Subsequent shots are fired single-action until the magazine is empty, the hammer being cocked by the slide as it recoils from each shot. Note that the trigger pull is much lighter for these subsequent shots.

8. For greater accuracy and consistent trigger pull, the hammer may be manually cocked by the shooter before the first shot is fired. **Keep your finger off the trigger while cocking the hammer!** The hammer will be automatically cocked as described above for subsequent shots.

! WARNING - FIRING	
	The slide automatically opens and shuts quickly while firing. Keep face and hands away from rear. Hot brass is ejected quickly and can burn you. Always wear shooting glasses and hearing protection.
SLIDE OPENS FAST - HOT BRASS EJECTED	

9. Immediately following the firing of a shot, and if a subsequent shot is not to be fired at once, depress the decocking lever until the hammer drops while the pistol is still pointing in a safe direction downrange. Remember that the pistol can still be fired by a full "double action" trigger pull.

10. When the last cartridge loaded into the pistol has been fired, the magazine follower presses the slide stop upward to engage the slide automatically holding the action open. **If the slide is shut, the shooter should always assume that there is a cartridge in the chamber!**

Don't rely on your memory to know if a gun or magazine is loaded. Visually inspect the magazine and chamber.

TO UNCOCK (DECOCK) THE PISTOL

With the muzzle pointed in a safe direction, depress the cocking lever fully. The hammer will drop near the end of the lever's travel. Although this may appear startling, it is important to note that the firing pin is securely blocked by the lever, and the pistol will not fire when the lever is depressed. **Manually decocking the hammer with the thumb is neither necessary nor recommended. Always use the decocking lever. Remember that when you release the decocking lever, it will automatically return to the firing position, and the pistol will then fire when the trigger is pulled if a cartridge is in the chamber.** (See "Special Feature - Decocking Lever", p. 6)

! WARNING - HANDLING	
	Do not load the pistol until you are ready to use it, and unload it immediately when you have completed shooting. (See "Unloading Warning" on page 12)
	If dropped or struck, the pistol may fire. Keep chamber empty unless actually firing! Use decock lever to decock pistol before moving with pistol or when not actually firing.
For maximum safety when carrying the pistol with a loaded magazine in place, the chamber should be empty, the slide should be closed, and the pistol should be decocked. Never carry it cocked! If placed into a holster, check it to be sure that the slide is not retracted far enough to either chamber a cartridge from the magazine or cock the pistol.	
The user should never depend on any mechanical device to justify careless handling or permitting the pistol to point in an unsafe direction. The shooter should always be alert to the possibility of accidental discharge. The only absolutely safe pistol is one in which the slide is open, the chamber is empty, and there is no magazine in the gun.	
ANY GUN MAY FIRE IF DROPPED	

TO LOAD AND FIRE (WITHOUT MAGAZINE)

In the event that the magazine is missing or for training purposes (where it is desirable that only one cartridge be loaded and fired at a time for safety), the pistol can be fired with the magazine removed. To do so, **keep the pistol pointed in a safe direction,** grasp the slide, and retract it fully to the rear. Next, push the slide stop upward so that the slide remains to the rear. Insert a single cartridge directly and fully into the chamber. Taking care to keep the pistol pointed in a safe direction, depress the slide stop. This will cause the slide to move vigorously forward into the firing position. **WARNING: The pistol is ready for instant use in the single-action mode once the slide moves forward.**

Finally, depress the decocking lever until the hammer drops -- now the pistol can be fired in the double-action mode. Single-action firing is possible by manually cocking the hammer. Note that the slide will not automatically remain open if the pistol is fired without the magazine in place. The ejector must always be pivoted to its rearward (upward) position when firing the pistol without the magazine.

⚠ WARNING - UNLOADING



So that the pistol can be used as a single loader, it will fire whether or not a magazine is in the gun if a cartridge is chambered. **Removing magazine does not unload pistol!** To unload, **first** remove magazine, **then** pull slide to rear, eject chambered cartridge, and **visually inspect chamber** to be sure it is empty. Always point the pistol in a safe direction when loading or unloading.

GUN WILL FIRE WITH MAGAZINE OUT

TO UNLOAD

WARNING: This sequence must be followed exactly as outlined. Failure to do so can result in the chamber being unintentionally loaded with a live cartridge!

1. The muzzle of the pistol must be pointing in a safe direction at all times, and fingers should be outside of the trigger guard. Decock the pistol by depressing the decocking lever until the hammer drops (See Figure 1, p. 6).
2. Remove the magazine from the pistol by pushing in on the magazine latch. **REMEMBER** that even though the magazine has been removed, a live round remaining in the chamber can still be fired (see "Unloading Warning", above).
3. Hold the pistol firmly and grasp the slide. Retract the slide to its rearmost position briskly to extract and eject any chambered cartridge. **Always visually double check that the chamber, breech-face, and the interior of the frame are clear of any live rounds.** When the slide is fully retracted, push upward on the slide stop, then allow the slide to move forward until it comes to rest with the rear projection of the slide stop resting in the notch on the lower left side of the slide.
4. To close the slide, **again check to be sure the chamber and breech-face are empty.** Pull the slide to its rearmost position and release it. The slide will snap forward. Keep fingers out of ejection port on top of slide!
5. If the magazine contains cartridges, they can be removed by sliding each cartridge forward and out of magazine, one at a time, until the magazine is empty.
6. Push empty (unloaded) magazine into frame until magazine latch locks it in place.

⚠ WARNING - SLIDE RETRACTION



The slide should always be pulled rearward ("retracted") by pulling the rear portion of the slide in the vicinity of the safety, the decock-only lever, or the serrations (depending upon model). **Always keep fingers away from trigger!**



Never put any part of your hands or body over the muzzle while retracting the slide for loading, unloading, inspection, or clearing a malfunction.

KEEP HANDS AWAY FROM MUZZLE AND FINGER OFF TRIGGER

CORRECT UNLOADING SEQUENCE



TO RELOAD THE PISTOL



1. Firing all cartridges in the magazine and the chamber will cause the slide to automatically lock open. **Keep the pistol pointed in a safe direction.** Reloading can be accomplished by pressing inward from the left side of the magazine latch with the thumb or forefinger. The magazine will fall free of the pistol of its own weight. To avoid the possibility of damage to the magazine, do not let it fall to the ground unless rapid reloading is absolutely necessary.
2. Insert a loaded magazine. **WARNING: The slide stop is held in place by a spring detent. Therefore, when there is a loaded magazine in place and the pistol is jarred, the slide can fly forward and chamber a cartridge.**
3. Release the slide to move forward by either depressing the rear portion of the slide stop or pulling the slide fully to the rear, depress the slide stop, and release the slide. A cartridge will be chambered when the slide shuts. **WARNING: The pistol is ready for instant use in the single-action mode once the slide moves forward. If the pistol is not to be fired immediately, depress the decocking lever until the hammer drops -- in this position, the pistol is ready to fire double action or can be recocked to fire single-action.**

TO EXTRACT AND EJECT A CHAMBERED CARTRIDGE

When the pistol is fired, the same gas pressure that drives the bullet forward also acts through the cartridge case to push the slide to the rear. The action causes extraction and ejection of the fired cartridge case. If a cartridge fails to fire or if the shooter wishes to eject the chambered cartridge manually, follow the procedure "To Unload" step 3, p. 12. When the slide is operated by hand, there can be a failure to extract the cartridge from the chamber, or a failure to eject the cartridge clear of the pistol. These failures usually are the result of the slide not being pulled rearward vigorously. From the foregoing, it is clear that the gun user must:

1. Always visually check the chamber and the breech-face after opening the slide to eject a chambered cartridge. If the slide is not vigorously retracted when being operated by hand, the extracted cartridge can be "ejected" into the magazine-well of the grip frame or remain held to the breech-face by the extractor.
2. Thoroughly clean the chamber and the extractor as often as necessary.

If an empty magazine is in the pistol when the slide is being hand retracted to extract a cartridge, the cartridge may drop on top of the magazine or remain held to the breech-face by the extractor. Then when the slide goes forward, the cartridge will be chambered again! **Remember — always remove the magazine before clearing the chamber, and visually ensure that no cartridges remain in the gun.**

WARNING - MALFUNCTIONS	
	<p>Any autoloading pistol may occasionally malfunction. If a cartridge hangs up, jams, or binds when being chambered, do not attempt to force it into the chamber by pushing or striking the slide. Carefully remove it.</p> <p>Most failures of a cartridge to feed or to chamber properly are caused by a damaged magazine, incorrect gun handling, insufficient lubrication, or improper ammunition.</p> <p>Whatever the cause, the user of the pistol must, above all, recognize that any cartridge jam can result in the very potentially dangerous situation of a cartridge discharging before it is properly chambered. If this happens, the cartridge case may rupture and its fragments fly out of the ejection port of the pistol with sufficient force to cause serious injury. Always wear shooting glasses!</p>
	<p>HITTING PRIMER CAN BURST CARTRIDGE</p>

TO CLEAR A MALFUNCTION ("JAM")

1. **Be certain the muzzle is continually pointed in a safe direction and that the hammer has been decocked.**
2. If possible, first remove the magazine. It may be necessary to manually remove a jammed cartridge that has only been partially stripped from the magazine. If so, use extreme care. Lock the slide open with the slide stop before attempting to clear the jam. Drawing the slide fully to the rear may bring the jammed cartridge along. **Keep your face away from the ejection port during this operation.** When attempting to clear a jam, use only wood "tools" so that the cartridge will not be damaged or the primer ignited. A 3/16" wooden dowel with a point on one end is useful.
3. Visually check to make sure that all cartridges have been removed from the pistol. Safely dispose of any cartridges involved in a malfunction incident. Do not use damaged ammunition in any firearm.

TO MINIMIZE MALFUNCTIONS ("JAMS")

1. If it appears that the jam was caused by the type of ammunition being used, try another brand, type, or lot number. Remember — use only factory ammunition of the correct type.
2. If changing ammunition does not at once eliminate malfunctions, then the following steps should be taken:

- Thoroughly clean the pistol, paying particular attention to the removal of accumulated grease and dirt. Use a bristle brush and solvent to remove grease and fouling from the breech-face, extractor, chamber, and feed ramp area immediately behind the chamber.
- Check to be sure that the magazine spring firmly returns the magazine follower to the top of the magazine.
- Check the magazine lips to be certain that they are free of nicks and burrs and that they are not deformed or cracked.
- Remove excess oil and solvent from all cleaned components, load the magazine, and try the pistol again. Make sure you are following the correct loading and firing sequence as described in this manual.
- If none of the above steps is effective, try a different magazine of Ruger manufacture. If a new magazine does not function correctly, return the pistol and magazines to the Ruger Product Service Department. (See Shipping Firearms For Repair" on page 21.)
- Alterations to the pistol or use of non-Ruger magazines and accessories may cause malfunctions. See "Alteration Warning" on page 3.

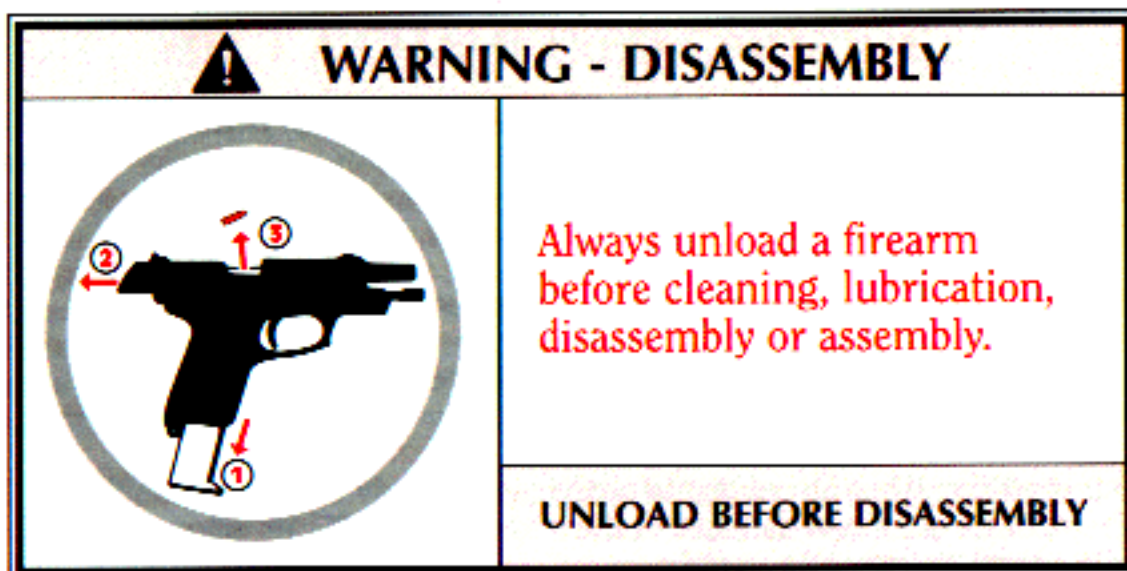

TO DISASSEMBLE
Be sure pistol is unloaded!

- Keep pistol pointed in a safe direction. If the pistol is cocked, depress the decocking lever until the hammer drops. Press inward on the left side of the magazine latch and withdraw magazine from butt of pistol.
- Pull slide to rear and lock in open position by pressing upward on rear end of slide stop. Again, be sure chamber is empty!
- Keep upward pressure on slide stop to prevent forward movement of slide. Open slide is under strong spring tension and could injure fingers if allowed to slam shut. Insert finger through top of slide and push ejector downward and forward (see Figure 3, p. 17) until it locks in its lower position. This will permit forward movement of slide. Further disassembly is impossible unless this is done.

- Remove fingers from ejection port. Grasp slide tightly. Now press down on slide stop and allow slide to move slowly forward until the vertical disassembly line on the frame is aligned with the vertical disassembly line on the slide (See Figure 4, below). Press in on right-hand end of slide stop and pull slide stop out of frame to the left until it is withdrawn completely out of the frame. (See Figure 5, below).
- Push slide forward and remove entire slide assembly to the front.
- Note:** Camblock is under strong spring tension. With slide held upside down, lift rear end of camblock/recoil spring assembly to disengage it from its seat against the barrel lug. Withdraw the camblock/recoil spring assembly to the rear of the slide.
- Pull barrel upward out of slide slightly and withdraw to the rear.
- This completes normal fieldstripping for routine cleaning and lubrication purposes. Further disassembly of slide or frame components is not recommended and should only be undertaken by the factory.

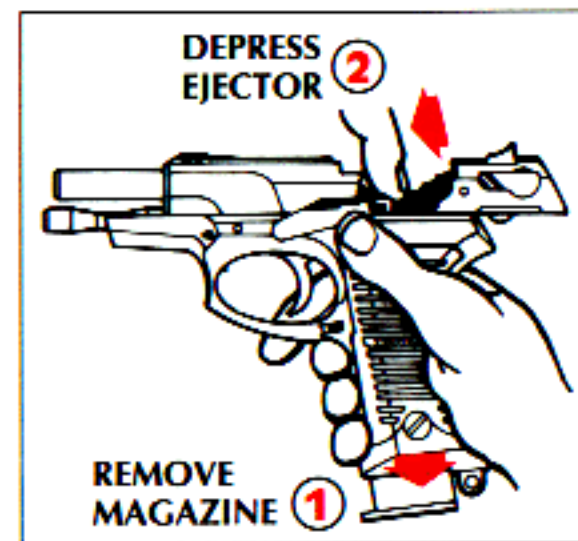

FIGURE 3
Press slide stop up. Depress ejector.

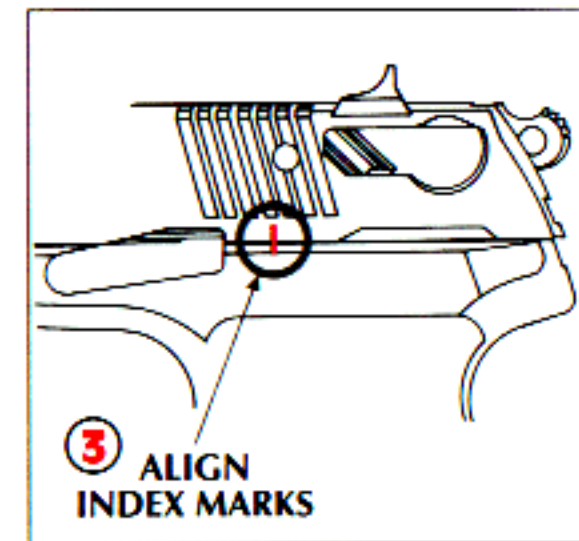

FIGURE 4
Index marks aligned.

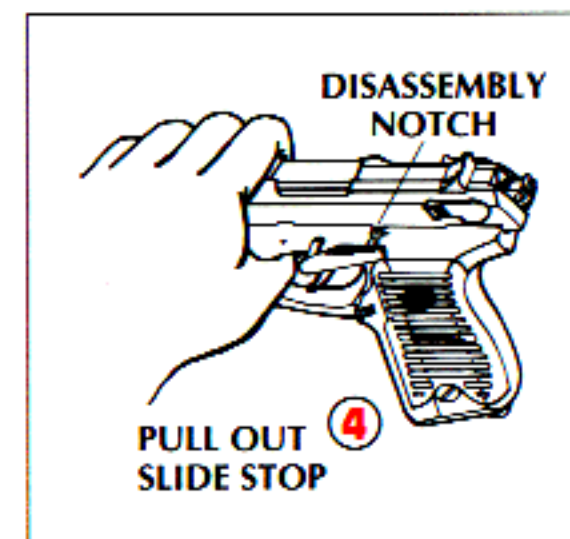

FIGURE 5
Slide stop in disassembly position.

TO REASSEMBLE

1. **BE CERTAIN CHAMBER AND MAGAZINE ARE EMPTY.**
2. With slide held upside down, replace barrel and push it rearward into its locked position.
3. Replace camblock and recoil spring into position. Rear end of camblock seats against barrel lug.
4. Be certain that ejector is locked in its lower (forward) position and that hammer is in its fired (uncocked) position.
5. Replace slide onto frame. Partially insert slide stop into frame.
6. Pull slide back until disassembly line on frame is aligned with disassembly line on slide stop. Now push slide stop all the way through the frame to the right.
7. Allow slide to move fully forward.
8. Replace empty magazine in frame through butt of pistol. This action returns the ejector to its working position. This pistol will not function normally unless the ejector is in its upward (rearward) position.

MAGAZINE INSPECTION AND CARE

Check the magazine frequently. The magazine follower must move freely and have adequate spring tension so that each cartridge is quickly raised to the feeding position. The magazine lips should be clean and free of cracks, dents, or nicks, so that cartridges are held in their proper feeding position.

If the magazine becomes dirty, it should be disassembled and thoroughly cleaned.

Snap-On Base - Use a punch to press in on the magazine spring seat where it protrudes into the hole in the magazine floorplate. Slide the magazine floorplate toward the front of the magazine, taking care to prevent the forcible ejection of the magazine spring seat and compressed magazine spring. Withdraw magazine spring seat and magazine spring from magazine body. Turn magazine upside down and remove magazine follower. Reassemble in reverse order.

When cleaning is necessary, use a solvent that will not rust the metal components or adversely affect the magazine follower. After the magazine has been soaked in solvent to loosen foreign matter, be certain to shake it vigorously (with the loading opening away from you) to remove solvent or residue from within the magazine. **Penetrating oils and solvents inside a magazine can "kill" or weaken cartridge primers, which can result in failures to fire or other possibly dangerous malfunctions, such as leaving a bullet in the bore!**

After cleaning, check to be certain that the magazine follower movement and spring tension are correct, and that no solvent or debris remain. **Improper reassembly of the magazine spring can cause a potentially dangerous malfunction. If cleaning does not restore proper tension, or if you experience a problem with the magazine, don't use it. Get a new one.**

CARE AND CLEANING

Be Sure Gun Is Unloaded!

BEFORE CLEANING, BE CERTAIN THE PISTOL AND ITS MAGAZINE CONTAIN NO CARTRIDGES. (See "Unloading Warning", p.12)

At regular intervals, or whenever the pistol has been exposed to sand, dust, extreme humidity, condensation, immersion in water, or other adverse conditions, disassemble, clean, and oil it. Proper periodic maintenance is essential to the reliable functioning of any firearm.

To clean the pistol, proceed as follows:

1. Disassemble (fieldstrip) the pistol to the extent described on pages 16 & 17.
2. Using a cleaning rod, run a solvent-wetted patch through the bore several times. Then attach a solvent-wetted bristle brush to the rod and run it back and forth the full length of the bore as many times as necessary to remove grease and dirt from the bore and chamber. Clean bore with dry patches and examine. Bore fouling can contribute to reduced accuracy, and grease accumulation in the chamber can interfere with proper feeding of cartridges from the magazine.
3. Using powder solvent on a clean patch or bristle brush, remove powder residue from all components of the mechanism. After cleaning, run a dry patch through the bore, then follow with a patch that is very lightly oiled. Wipe all surfaces clean with cloth, then wipe all surfaces with a patch or cloth that has been very lightly oiled.
4. **NOTE:** Only a light application of oil is needed to provide adequate lubrication of moving parts and to prevent rust. Excess accumulations of oil tend to attract particles of dust and dirt and may congeal in cold weather, which can interfere with the safe and reliable function of the pistol.

⚠ WARNING - LUBRICATION	
	<p>Firing a pistol with oil, grease, or any other material even partially obstructing the bore may result in damage to the pistol and serious injury to the shooter and those nearby. Do not spray or apply lubricants directly on ammunition. If the powder of a cartridge is affected by the lubricant, it may not be ignited, but the primer firing may push the bullet into the bore where it may be lodged. Firing a subsequent bullet into the obstructed bore may damage the pistol and cause serious injury or death to the shooter and those nearby. Use lubricants properly. You are responsible for the proper care and maintenance of your firearms.</p>
IMPROPER LUBRICATION DESTROYS GUNS	

5. Before firing, remove all oil and grease from the bore. Do not keep the pistol stored in a leather holster or case. Leather attracts moisture, even though the holster or case may appear to be perfectly dry.

⚠ WARNING - STORAGE	
	<p>Never place or store any firearm in such a manner that it may be dislodged. Firearms should always be stored securely and unloaded, away from children and careless adults.</p>
STORE SECURELY & UNLOADED	

SIGHT ADJUSTMENT

The **RUGER® P97DC** pistols are equipped with a rear sight which is adjustable for windage only. After the rear-sight lock screw has been loosened (for those pistols equipped with a rear sight lock screw), the rear sight can be drifted laterally in its dovetail on the top of the slide by tapping it with a wooden- or plastic-headed hammer or similar implement. Move the rear sight in the direction you want the shot to move on the target. After the rear sight is adjusted, tighten the rear-sight lock screw. The front sight is fixed. Both front and rear sights are provided with white-dot inserts for rapid target acquisition and easy alignment of the sights to obtain a correct sight picture.

SERVICE AND PARTS POLICY

If you have any questions with regard to the performance of your **RUGER® P97DC** pistol, please call (520) 778-6555 or write to our Product Service Department in Prescott, Arizona, fully describing all circumstances and conditions involved. If you should return your pistol to the factory for repair, or order parts for it, please comply with the following suggestions for prompt service:

	<p>WARNING—BEFORE SHIPPING ANY FIREARM, BE ABSOLUTELY CERTAIN THAT IT AND ITS MAGAZINE ARE UNLOADED. DO NOT SHIP CARTRIDGES WITH A FIREARM.</p>
---	--

SHIPPING FIREARMS FOR REPAIR

RUGER® P97DC pistols returned to the factory for services or repair should be sent to: Sturm, Ruger & Company, Inc., Product Service Department, 200 Ruger Road, Prescott, AZ 86301-6181. Telephone: (520)778-6555.

Guns should be sent prepaid. We will not accept collect shipments.

The Federal Gun Control Act as well as the laws of most States and localities, do not prohibit an individual (who is not otherwise barred from purchasing or possessing a firearm) from shipping a firearm directly to the manufacturer for repair. However, before you ship your pistol to us, be certain that your State or locality does not have a law or regulation which will prohibit you from receiving the pistol from us after it has been repaired. If such receiving is prohibited, then please have a Federally Licensed firearms dealer ship the gun to us. If your pistol is sent to us by a dealer, it will be returned to him after being repaired. If a handgun (pistol or revolver) is shipped by an individual who does not hold a Federal Firearms License, it must be shipped via U.P.S. Persons who do not hold a Federal Firearms License are prohibited by Federal law from shipping a handgun by Mail. Handguns mailed in violation of the law are impounded by the Post Office.

Please do not include holster, custom grip panels, or accessories with a firearm being shipped to the factory for service. **DO NOT SEND GUN BOXES OR LITERATURE THAT YOU CONSIDER TO BE COLLECTOR'S ITEMS – THESE ARE INVARIABLY DAMAGED OR DESTROYED IN SHIPMENT.** Always insure your shipment.

Enclose a letter which includes your name, address, telephone number, and serial number and model of the firearm. Describe in detail the trouble you have experienced with your firearm, or the work you wish to have done. Merely stating that the firearm "needs repair" is inadequate information. Please enclose copies of any previous correspondence.

Work performed will bear a net minimum labor charge of \$15.00 plus a \$5.00 shipping and handling charge. The charge for metal refinishing the **RUGER® P97DC** pistol (except the synthetic grip frame, which we cannot refinish) is \$35.00, plus a \$5.00 shipping and handling charge. Custom gunsmithing service or nonstandard alterations are **NOT AVAILABLE** from Ruger Product Service Departments.



WARNING - PARTS PURHASERS

It is the purchaser's responsibility to be absolutely certain that any parts ordered from the factory are correctly fitted and installed. Firearms are complicated mechanisms and **IMPROPER FITTING OF PARTS MAY RESULT IN A DANGEROUS MALFUNCTION, DAMAGE TO THE FIREARM, AND SERIOUS INJURY TO THE SHOOTER AND OTHER PERSONS.** The purchaser and installer of parts must accept full responsibility for the correct adjustment and functioning of the pistol after such installation.



PARTS MUST FIT CORRECTLY

ORDERING PARTS

Please contact the Arizona Parts Department for parts availability and current prices. All parts orders for the **RUGER® P97DC** should be sent to: Sturm, Ruger & Company, Inc., Parts Department, 200 Ruger Road, Prescott AZ 86301-6181. We cannot comply with open account or C.O.D. requests. Payment in the form of a check, money order, Visa or Mastercard must accompany your order. Credit Card orders must include the account number, expiration date and whether it is a Visa or Mastercard account. Minimum parts order is \$1.00 plus a \$3.50 shipping and handling charge. Order parts by Part Number and Part Name, include the entire serial number of the firearm for which the parts are being ordered. The price shown for parts does not include the minimum net labor charge of \$15.00 plus \$5.00 shipping and handling charge if the parts are factory fitted. All factory-fitted parts are fitted on an exchange basis only. We will not return the replaced parts.

Because it is a serial numbered component, the Ruger autoloading pistol frame (part number V00285) is defined as a "firearm" by Federal law and is not sold as a separate component.

*Parts designated by an asterisk must be factory fitted. These parts are fitted on an exchange basis only. We will not return the replaced parts. We will not return any part that is broken, malfunctioning, badly worn or has been modified. See "Warning - Parts Purchasers", above.



CAUTION: A gun containing modified, broken, malfunctioning, or badly worn parts should not be fired!

RUGER® P97DC PARTS LIST

Design, prices and specifications subject to change without notice.
SPECIFY MODEL WHEN ORDERING
(See Exploded View on Page 26.)

Part Name	Part No.	Model
* Barrel	KV00624	P97DC
* Blocker Lever	KV02114	P97DC
Camblock	KV07005-100	P97DC
Case Combo, .45ACP, Not Illustrated	PGCC-45ACP	P97DC
Case Only, Not Illustrated	PGC-CF	P97DC
Decocker Lever, Assembly, Left	KV01522-100	P97DC
Decocker Lever, Right	KV01555	P97DC
Decocker Lever Spring	V06480	P97DC
Decocker Lever Spring Pin, Not Illustrated	KV06460	P97DC
Decocker Lever Spring Retainer	KV06520	P97DC
Ejector	V00911	P97DC
Ejector Pivot Assembly	KV26600	P97DC
Ejector Spring	V00902	P97DC
Extractor	KV01406	P97DC
* Firing Pin	KQ01109	P97DC
* Firing Pin Block	KQ05000	P97DC
* Firing Pin Block Spring	KQ05600	P97DC
* Firing Pin Spring	KV01850	P97DC
Frame	V00285	P97DC
Front Sight, Must Be Drilled For Cross Pin	V03203	P97DC
Front Sight Cross Pin, 2 Req'd.	V04700	P97DC

Part Name	Part No.	Model
* Hammer	KV04005	P97DC
* Hammer Assembly	KV04005-100	P97DC
Hammer Pivot Pin	V02302	P97DC
Hammer Spring	V00400	P97DC
Hammer Spring Seat	V02403	P97DC
Hammer Spring Seat Detent	KV05301	P97DC
Hammer Spring Seat Pin	V02551	P97DC
Hammer Strut	V01601	P97DC
Hammer Strut Pin, Not Illustrated	KV05150	P97DC
Lock & Keys, Brass	W11001	P97DC
Lock & Keys, Iron	W11002	P97DC
Magazine, Complete, 8-Shot Capacity	P-16/8	P97DC
Magazine, Complete, 7-Shot Capacity	P-16	P97DC
Magazine Floor Plate, Not Illustrated	Q01020	P97DC
Magazine Follower, Not Illustrated	Q02910	P97DC
Magazine Latch	KV02605	P97DC
Magazine Latch Spring	V02701	P97DC
Magazine Loader, Not Illustrated	QML	P97DC
Magazine Shell	KQ00500	P97DC
Magazine Spring, Not Illustrated	V03006	P97DC
Magazine Spring Seat, Not Illustrated	KQ03100	P97DC
* Plunger	KH05100	P97DC
Rear Sight	Q03300	P97DC
Rear Sight Lock Screw	V08001	P97DC
Recoil Spring, Inner	V02819	P97DC
* Sear	KV02214	P97DC
Sear Pivot Pin, 2 Req'd.	KV04450	P97DC
Sear Spring	KV06420	P97DC
* Slide	KV00123	P97DC
Slide Stop Assembly	KV03715-100	P97DC

Part Name	Part No.	Model
Trigger	KV03911	P97DC
* Trigger Bar	KV01715	P97DC
Trigger Bar Spring	V05402	P97DC

* PARTS SO MARKED MUST BE FACTORY FITTED

RUGER® P97DC EXPLODED VIEW

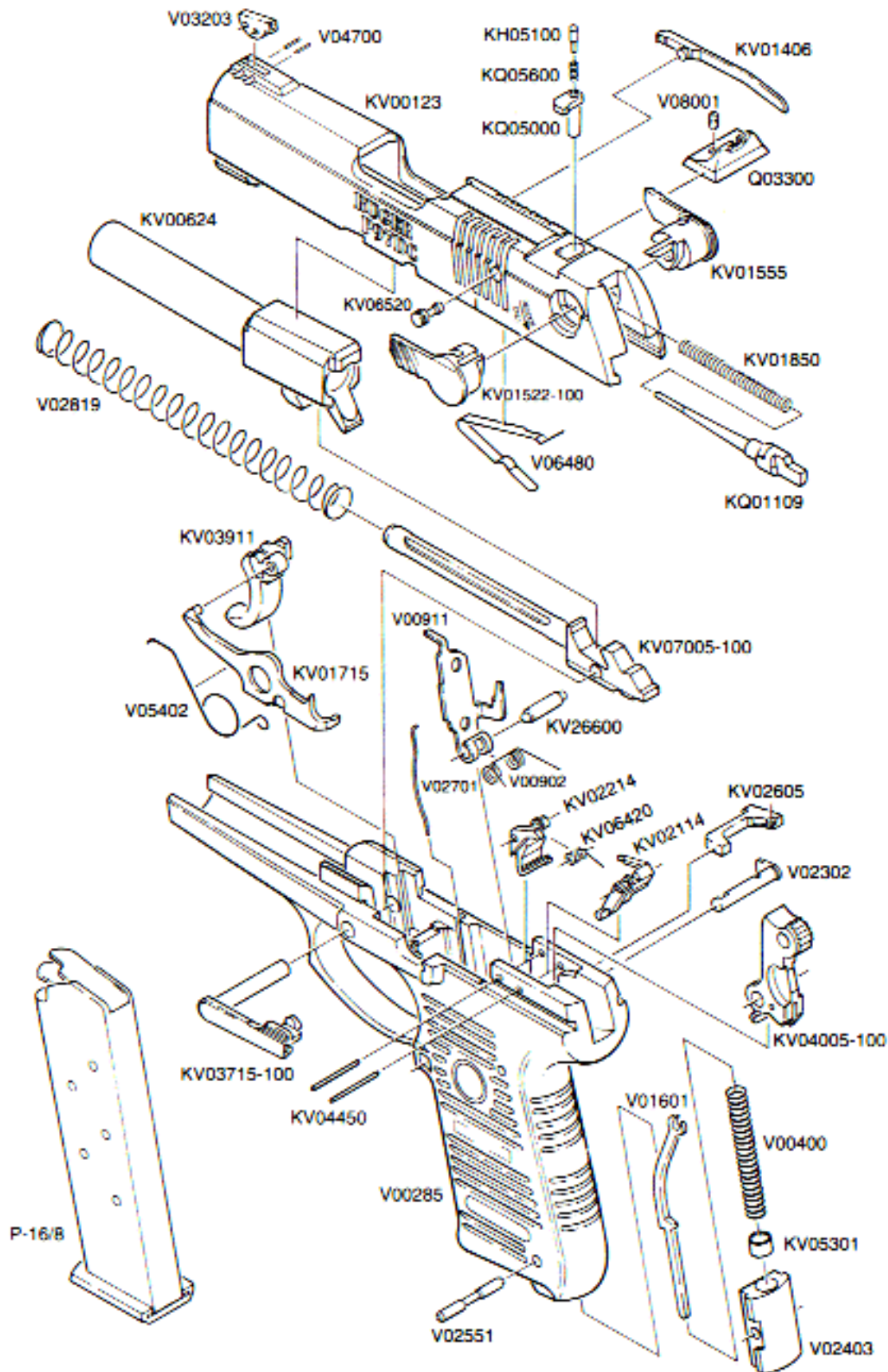

THE BASIC RULES OF SAFE FIREARMS HANDLING

We believe that Americans have a right to purchase and use firearms for lawful purposes. The private ownership of firearms in America is traditional, but that ownership imposes the responsibility on the gun owner to use his firearms in a way which will ensure his own safety and that of others. When firearms are used in a safe and responsible manner, they are a great source of pleasure and satisfaction, and represent a fundamental part of our personal liberty.

Firearms do not cause accidents! Firearms accidents are almost always found to have been the result of carelessness, or ignorance on the part of the shooter of the basic rules of safe gun handling.

The following rules must be observed by gun users at all times. Safe gun handling is not just desirable, it is absolutely essential to your safety, the safety of others, and the continuation of gun ownership and sport shooting as we know it today.

1. LEARN THE MECHANICAL AND HANDLING CHARACTERISTICS OF THE FIREARM YOU ARE USING.



Not all firearms are the same. The method of carrying and handling firearms varies in accordance with the mechanical provisions for avoiding accidental discharge and the various proper procedures for loading and unloading. No person should handle any firearm without first having thoroughly familiarized himself with the particular type of firearms he is using, and with safe gun handling in general.

2. ALWAYS KEEP THE MUZZLE POINTED IN A SAFE DIRECTION.



Be sure of the bullet stop behind your target, even when dry-firing. Never let the muzzle of a firearm point at any part of your body or at another person. This is particularly important when loading or unloading a firearm. In the event of an accidental discharge, no injury can occur as long as the muzzle is pointing in safe direction. A safe direction means a direction which will not permit a discharged bullet to strike a person, or to strike an object from which the bullet may ricochet.

A safe direction must take into account the fact that a bullet may penetrate a wall, ceiling, floor, window, etc., and strike a person or damage property. Make it a habit to know exactly where the muzzle of your gun is pointing whenever you handle it, and be sure that you are always in control of the direction in which the muzzle is pointing, even if you fall or stumble. Keep your finger off the trigger until you are ready to shoot.

3. FIREARMS SHOULD BE UNLOADED WHEN NOT IN USE.



Firearms should be loaded only when you are in the field or on the target range or shooting area, ready to shoot. Firearms and ammunition should be securely locked in racks or cabinets when not in use. Ammunition should be safely stored separate from firearms. Store your firearms out of sight of visitors and children. It is the gun owner's responsibility to be certain that children and persons unfamiliar with firearms cannot gain access to firearms, ammunition, or components.

4. BE SURE THE BARREL IS CLEAR OF OBSTRUCTIONS BEFORE SHOOTING.

Even a bit of mud, snow or excess lubricating oil or grease in the bore may cause the barrel to bulge, or even burst on firing, and can cause serious injury to the shooter and bystanders. Be sure that you are using ammunition of the proper caliber and loading for the gun you are using. If the report or recoil on firing seems weak, or doesn't seem quite right, **CEASE FIRING IMMEDIATELY**, unload your firearm, and check to be sure that no obstruction has become lodged in the barrel. Never try to shoot an obstruction out!



5. BE SURE OF YOUR TARGET BEFORE YOU SHOOT.

Don't shoot unless you know exactly where your bullet is going to strike. Be sure of the bullet stop behind your target, even when dry-firing with an unloaded gun. If you are in the field hunting, do not fire at a movement or noise. Take the time to be absolutely certain of your target before you pull the trigger.

6. WEAR SHOOTING GLASSES AND HEARING PROTECTORS WHEN YOU SHOOT.

All shooters should wear protective shooting glasses and adequate hearing protection when shooting. Exposure to shooting noise can damage hearing, and adequate eye protection when shooting is essential.



7. NEVER CLIMB A TREE OR FENCE WITH A LOADED FIREARM.

Put the firearm down carefully before climbing a fence, and unload it before climbing or descending a tree or jumping over a ditch or other obstruction. Never pull or push a loaded firearm toward yourself or another person. When in doubt, or whenever you are about to do anything awkward, unload your gun!



8. DON'T SHOOT AT A HARD SURFACE, OR AT WATER.

Bullets can glance off many surfaces like rocks or the surface of water and travel in unpredictable directions with considerable velocity.



9. NEVER TRANSPORT A LOADED FIREARM.

Firearms should always be unloaded before being moved or placed in a vehicle. A suitable carrying case or scabbard should be used to carry an unloaded firearm to and from the shooting area.

10. AVOID ALCOHOLIC BEVERAGES WHEN SHOOTING.

Don't drink until the day's shooting is over. Handling firearms while under the influence of alcohol in any form, or medications that could affect your judgment or co-ordination, constitutes a criminal disregard for the safety of others.



A BRIEF ACCOUNT OF AN EXTRAORDINARY ACHIEVEMENT: RUGER FIREARMS

One of the few American firearms manufacturers whose management has remained unchanged since starting in business, Sturm, Ruger & Company, Inc. had its beginning in a small machine shop occupying a rented frame building in Southport, Connecticut. In January 1949, with an initial investment of only \$50,000 and an idea, William B. Ruger and Alexander M. Sturm started production of a .22 caliber autoloading pistol -- a design which was so successful that it became the cornerstone upon which one of the most comprehensive lines of sporting firearms ever made in America was established. After Alex Sturm's death in 1951, William B. Ruger continued to direct the company alone and today, as Chairman of the Board, he is actively involved in the creative engineering of new products and continues to provide the leadership which has made this 50-year-old company a sound and successful enterprise.

Sturm, Ruger & Company, in this relatively short time, has established itself as a leading small arms design organization, developing a unique and broad line of fine quality sporting, military and police firearms to become one of the world's most famous producers of revolvers, pistols, rifles and shotguns. From 1949 thru 1999 Ruger craftsmen have built many millions of firearms.

During its five decades of growth and progress under the leadership of William B. Ruger, the company has developed a business philosophy and implemented policies which represent a constructive influence in the life of modern America. From the beginning, Sturm, Ruger & Company played a positive role in conservation efforts and has supported the interests of shooters through such groups as the National Rifle Association, National Shooting Sports Foundation, and many regional sportsmen's organizations. The company has always endeavored to market its firearms for constructive and recreational purposes, to emphasize the traditional aspects of shooting, to render meaningful public services and to encourage shooters in constructive and responsible participation in the shooting sports.

Today, Sturm, Ruger & Company is particularly mindful of those elements which have contributed to the creation of its success, and extends heartfelt thanks to its many loyal employees and customers.

A current catalog of Ruger firearms is available free upon request to Sturm, Ruger & Co., Inc., Southport, CT 06490.

