

Owner's Manual

Instruction Book for:
MODELS 700ML & 700MLS
IN-LINE BOLT ACTION
MUZZLELOADING RIFLES

Remington®

IMPORTANT!

READ ALL INSTRUCTIONS
AND WARNINGS IN THIS
BOOK BEFORE USING THE FIREARM.



PAGE 2.....THE TEN COMMANDMENTS OF
FIREARM SAFETY

PAGE 9.....IMPORTANT PARTS OF THE FIREARM

PAGE 12.....HOW TO LOAD AND UNLOAD

PAGE 19.....CLEANING INSTRUCTIONS

PAGE 23.....HOW TO OBTAIN PARTS AND SERVICE

A Tradition of Performance and Safety.

In 1816 Eliphalet Remington was confident he could make a flintlock that was as good or better than any he could buy. His confidence was well founded. The barrel he handcrafted set a new standard for firearm accuracy and spawned generations of products that have made Remington® Arms America's leading gunmaker. While performance and style are certainly hallmarks of Remington firearms, one factor ultimately drives their performance. Safety. Eliphalet Remington never lost sight of the fact that his rifles were potentially lethal and could kill someone if handled improperly. And after more than 180 years the same holds true for any firearm, including your new Remington. Eliphalet Remington's first flintlock launched a proud tradition of accuracy and responsibility.



Eliphalet Remington's first flintlock launched a proud tradition of accuracy & responsibility.

Safety is Critical to Performance.

A superbly crafted gun is only as good as the hands that hold it. You can never be too careful. Shooting accidents are often caused by careless oversights such as failing to control the direction of the muzzle, failing to fully engage the safety, leaving ammunition in the chamber or using improper loads. These oversights can result in the destruction of life, limb or property. There's no calling back a bullet once it's been fired, so it's critical that you know the principles of safe gun handling and storage before you ever take your new Remington firearm out of the box.

The proper use and performance of your firearm depends on correct assembly and maintenance, so it's critical that you familiarize yourself with the information in this instruction book. Even if you're a veteran shooter with a collection of Remington firearms, take the time to read this literature. Not all firearms are the same. That means the first step in safe handling is to learn the features and requirements of your new Remington.

THE TEN COMMANDMENTS OF FIREARM SAFETY

The Ten Commandments of Firearm Safety should be etched in your memory forever. Let them govern your action wherever and whenever you're involved with firearms. In the field. On the range. Or in your home. Please take the time to review and understand these rules.

1st COMMANDMENT

Always Keep the Muzzle Pointed in a Safe Direction.

This is the most important gun safety rule. A safe direction is one in which an accidental discharge will not cause injury to yourself or others. Never allow your gun to point at anything you don't intend to shoot. Be especially careful when you're loading or unloading. Treat every gun as if it were loaded. And make it a habit to know where the muzzle is pointed at all times, even when your firearm is unloaded. No one will be injured by an accidental discharge if you keep your firearm pointed in a safe direction. It's as simple as that.



2nd COMMANDMENT

Firearms Should be Unloaded When Not Actually in Use.

Load your firearm only when you're in the field or on the target range and ready to fire. Never let a loaded gun out of your sight or out of your hands. Unload it as soon as you're finished shooting – before you bring it into your car, camp or home. Remember, unloading your firearm means unloading it completely, so there is no ammunition in the chamber or in the magazine. Before handling a firearm or passing it to someone else, visually check the chamber, receiver and magazine to be certain they do not contain ammunition. Always keep the gun's action open when not in use. Never assume a gun is unloaded even if you were the last person to use it. Always check for yourself.

Let common sense rule when you carry a loaded gun. If you're in a situation that could risk accidental discharge – such as crossing a fence, wading through a stream or climbing a tree – always unload your gun. Never pull or push a loaded firearm toward yourself or another person. And never carry a loaded gun in a scabbard, detached holster or gun case.

Certain firearms (including some Remington® rifles and shotguns) are equipped with internal security devices to prevent unauthorized use. In addition, some firearms owners use external devices, such as cable locks and trigger blocks, for the same purpose. Even if you use such a device, you should still keep your firearm unloaded when stored or not in use. And using internal or external devices cannot substitute, however, for securing your firearms and ammunition in a separate, locked location.

Safe storage of firearms is just as critical as safe handling. Never store guns loaded. Be sure to keep your firearms in a secure place where unauthorized persons cannot get their hands on them without your knowledge.

Take special care if there are children around. Kids are fascinated by guns. It's a natural curiosity that can have tragic consequences when not properly supervised. Store your firearms in a locked gun safe or some other location that physically bars a child from gaining access.

Ammunition should be stored and locked in a location separate from your firearm. Never leave an unsecured firearm or ammunition in a closet, dresser drawer or under the bed. Remember, it is your responsibility to make sure that children and others unfamiliar with firearms cannot get access to your firearm and ammunition.



Firearms should be stored in a secure place where children cannot access them. A gun safe is an ideal way to secure your firearm.

3rd COMMANDMENT

Don't Rely on Your Gun's Safety.

Treat every gun as if it can fire at any time, whether or not there's pressure on the trigger. Your firearm has been carefully designed to maximize performance and safety. However, because a gun's safety is a mechanical device, it could fail.

Human error is a more likely reason for a gun safety to fail. By mistake, you may think the safety is on when it really isn't. Or the safety may have been disengaged without your knowledge. Or you could think your gun is unloaded when there's actually a cartridge or shell in it. A mechanical safety is not a substitute for common sense. It's merely a supplement to your proper handling of a firearm.

Never touch the trigger on a firearm until you are ready to shoot. Keep your fingers away from the trigger when you're loading or unloading. And don't pull the trigger when the safety is engaged or positioned between safe and fire.

Before using your gun, read this instruction book to understand the exact location and operation of your firearm's safety. Even when the safety is on, maintain control of your loaded firearm and control the direction of the muzzle. In other words, don't rely on your safety to justify careless handling. If your firearm's internal mechanisms are broken or have been altered, your firearm may fire even when the safety is on. Remember, you and your safe gun handling practices are your gun's best safety.

4th COMMANDMENT

Be Sure of Your Target and What's Beyond It.

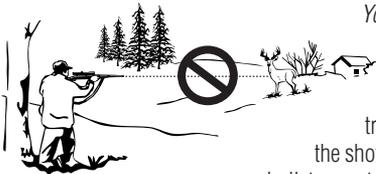

You can't stop a shot in mid-air, so never fire unless you know exactly where your shot is going and what it will strike. Never fire at a sound, a movement or a patch of color. A hunter in camouflage can easily be mistaken for a target by an impulsive shooter. Before you pull the trigger be absolutely sure of your target and what's behind it. Make sure the shot has a backstop such as a hillside or dense material like sand. Remember, bullets can travel great distances with tremendous velocity. Know how far your shot will go if you miss your target or the bullet ricochets.



Use Proper Ammunition

Every firearm is designed to use a certain caliber or gauge of ammunition. Using the wrong ammunition, mixing ammunition or using improperly reloaded ammunition can cause serious personal injury or death. And it only takes one cartridge or shotshell of the incorrect caliber or gauge, or which has been improperly reloaded, to destroy your firearm. It's your responsibility to make sure the ammunition you use exactly matches the caliber or gauge of your gun. Refer to this instruction book to find out the specific requirements of your firearm. Always read and heed the instructions on ammunition boxes.

Confusing shells or cartridges can cause serious personal injury or death and destroy your firearm. Examine your shells or cartridges closely and use only the precise caliber or gauge for your specific firearm. For example, suppose you accidentally loaded a 20 ga. shell into a 12 ga. shotgun. Because the 20 ga. shell is too small for the chamber, the 20 ga. shell could travel down the barrel and get lodged in the bore. If you then loaded a standard 12 ga. shell behind it and fired, the 12 ga. shot will slam into the lodged 20 ga. shell and may cause the barrel to explode right in your hand. This is commonly called a 12/20 burst, and it can kill you.

Check all ammunition before you load it to make sure it matches your gun's requirements. Every Remington® cartridge and shell is head-stamped with its caliber or gauge for easy identification. Likewise, you'll find the caliber or gauge of your new Remington firearm imprinted on the barrel.

Reloading Requires Extra Diligence.

If you're an ammunition reloader, you are responsible for personally assuring that the loads and components of your reloaded ammunition meet your gun's factory-tested standards. Never use ammunition which has been reloaded by someone else!

Many shooters handload as a hobby or to save money on commercial, factory-made ammunition. However, it requires a thorough knowledge of reloading procedures and a deep respect for the explosive potential of gunpowder.

Firearms are designed, manufactured and proof-tested to standards based on factory-loaded ammunition. Handloaded or reloaded ammunition that deviates, either intentionally or accidentally, from load or component recommendations can be very dangerous.

Reloaders must observe all possible safety precautions and practices related to the proper handling of explosives. Whether you're a seasoned reloader or just starting out, you should study the subject, watch reloading demonstrations and talk to experienced reloaders.

The first rule of reloading is to always follow the manufacturer's instructions for the components you're using. They'll tell you to follow certain guidelines. Namely:

1. Don't mix or substitute powders or primers.
2. Don't use unknown or substandard components.
3. Use only suitable components that have been factory-tested by reputable ammunition, powder and bullet manufacturers.
4. Always be sure to use the manufacturer's recommended recipe when reloading.

Not following these guidelines could result in severe injury to yourself or severe damage to your firearm. Dangerously high pressure and explosions can result from an overcharge of powder or other deviations from established reloading guidelines. Be very careful. The process of reloading exposes you to environmentally hazardous material. Lead, which is known to cause cancer and birth defects, is the most common substance in bullets and shot. It is important to handle lead bullets and shot with extreme care. Work only in a well-ventilated area and always wash your hands after exposure and before eating. Never smoke while reloading.

Primers and powders are also highly toxic and flammable. So after reloading be sure to clean up all materials from your work area. Don't leave primer or powder spills anywhere on the floor or bench top. Dispose of all waste material in accordance with the manufacturer's recommendations.

Finally, when reloading or handloading concentrate on what you're doing at all times. Do not be distracted by talking to others, listening to the radio or watching TV while reloading. Never reload after consuming alcoholic beverages or drugs of any kind. You are working with extremely hazardous materials and you can't risk even a few seconds of distraction. Remember, if you reload, you are the ammunition manufacturer and you are responsible for the performance and safety of your reloaded ammunition.

6th COMMANDMENT

If Your Gun Fails to Fire When the Trigger is Pulled, Handle With Care.

If for some reason the ammunition doesn't fire when you pull the trigger, stop and remember the 1st Commandment of Firearm Safety – always keep the muzzle pointed in a safe direction. Keep your face away from the breech, then put the safety on, carefully open the action, unload the firearm and dispose of the cartridge safely. Remember that anytime there's a shell in the chamber, your gun is loaded and ready to use. Even if you tried to shoot and your gun didn't fire, treat your firearm as if it could still discharge.

7th COMMANDMENT

Always Wear Eye and Ear Protection When Shooting.

Your sight and hearing risk injury from shooting and should be protected at all times. Wear protective shooting glasses to guard against falling shot, clay target chips, powder residue, ruptured cartridge cases and even twigs and branches in the field. Also be sure to wear eye protection when you're disassembling or cleaning a gun so that tensioned parts (like springs) and cleaning solvents don't come in contact with your eyes. Continued exposure to shooting noise can permanently damage your hearing. On the range, where shooting volume is the loudest, be sure to use the maximum protection of a headset. And learn to use ear protection in the field, especially in confined locations like duck blinds.



8th COMMANDMENT

Be Sure the Barrel is Clear of Obstructions Before Shooting.

Before loading your gun, open the action and make sure there's no ammunition in the chamber or magazine. Check the barrel for any obstructions or debris. Even a small amount of snow, mud, excess lubricant or grease in the bore can dangerously increase pressure and cause the barrel to bulge or burst when firing. Use a cleaning rod and patch to wipe away anti-rust compounds or any other residues or obstructions in the barrel. Never try to shoot out an obstruction by loading another shell and firing!

When firing, rely on your instincts. If the noise or recoil of your firearm seems weak, stop everything, unload your firearm and be sure nothing is lodged in the barrel. Remember the 12/20 burst? That's what can happen when the barrel is obstructed. So always be sure you're using the correct ammunition in your firearm and that it's free of obstructions.

9th COMMANDMENT

Don't Alter or Modify Your Gun and Have it Serviced Regularly.

Your firearm has been designed to operate according to certain factory specifications. You'll jeopardize your safety and that of others around you by attempting to alter its trigger, mechanical safety or other mechanisms. So never alter or modify your firearm in any way.

Like any mechanical device, a firearm is subject to wear. It must be maintained and periodically serviced to assure optimum safety and performance. Only a qualified service facility should service, repair or modify your Remington® firearm. Consult your instruction book for instructions on how to send your firearm to the factory or for the location of the nearest Remington repair station.

Proper cleaning and lubrication are also important to firearm maintenance and are necessary to assure accuracy, safety and reliability. Before cleaning, always make sure that your gun is completely unloaded. And always clean the barrel from the chamber end to the muzzle when possible.



Make it a practice to clean your bore every time you're going to shoot. Be sure to clean your entire gun before and after long-term storage and no less than once a year. It's also important to clean your gun whenever it's been exposed to adverse conditions such as rain, dirt, mud, snow, sleet or saltwater.

For safe and dependable operation of your firearm, all parts of your gun must be properly cleaned and lubricated. Periodically inspect the internal workings of your firearm to be sure they're clean and free of rust, unwanted dirt and debris.

Use recommended lubricants on your gun and do not over-lubricate. Excessive use of a non-recommended lubricant could adversely affect the function and safe operation of your firearm. Remember, you are responsible for the proper care and maintenance of your firearm. Failure to properly maintain your firearm can not only damage or ruin your firearm, it can expose you and others to unnecessary risks of personal injury or death.

Remington® has a wide range of firearm care products and resources for best results when cleaning your gun. Everything from solvents and lubricants to rods and patches. They're all available from your Remington dealer.

10th COMMANDMENT

Learn the Mechanics and Handling Characteristics of Your Firearm.

Not all guns are alike. They have different mechanical characteristics that dictate how you should carry and handle them. Anyone who plans to use a firearm should first become totally familiar with the type of firearm it is and the safe handling procedures for loading, unloading, carrying, shooting and storing it.

Before you even unpack your new Remington firearm, read this instruction book from cover to cover and familiarize yourself with the different component parts of the gun. Then read, understand and follow the Ten Commandments of Firearm Safety in this book.



WARNING! Discharging firearms in poorly ventilated areas, cleaning firearms or handling ammunition may result in exposure to lead, a substance known to cause birth defects, reproductive harm, cancer and other serious physical injury. Have adequate ventilation at all times. Wash hands thoroughly after exposure.

SHOOT SOBER!!

There's one other rule that must be followed when handling firearms. In fact, respect for this rule is necessary in order to effectively practice the Ten Commandments of Firearm Safety. The rule is: SHOOT SOBER! Guns and alcohol or drugs make a deadly combination. Never consume anything that would mildly impair your judgment or physical coordination when you're using a firearm. A staggering percentage of the shooting accidents that occur every year involve alcohol or drugs. Be smart. Always shoot sober and stay alive.

WARNING! Failure to follow any of these safety rules may cause personal injury or death to the shooter or bystander and damage to property. Do not use a firearm until you fully understand and practice the Ten Commandments of Firearm Safety. If you have any questions about the safe use of a Remington firearm, write to us at Remington Arms Company, Inc., Consumer Service, P.O. Box 700, Madison, NC 27025-0700, or call us at 1-800-243-9700.

SPECIAL SAFETY RULES FOR MUZZLELOADERS

In addition to the Ten Commandments of Firearm Safety, there are several guidelines specific to black powder guns that muzzleloaders must observe at all times to ensure their safety and the safety of others. The following is a brief overview of these guidelines. For full details, thoroughly read this instruction book.

MUZZLELOADING SAFETY RULES

1. **NEVER** smoke while using your muzzleloader or while near any quantity of black powder or PYRODEX.®
2. **BEFORE LOADING, MAKE SURE THE FIREARM IS NOT ALREADY LOADED.** To make sure it is unloaded, insert the ramrod provided with the rifle into the bore to the breech plug and note its position at the muzzle. It should be approximately 1/4 inch below flush with the end of the barrel if the rifle is not loaded.
NOTE: Nothing can be attached to the ramrod while using it in this way. USE ONLY THE RAMROD PROVIDED.

3. **ALWAYS CHECK AND CLEAR THE FLASH HOLE THROUGH THE NIPPLE BEFORE SHOOTING. ALWAYS CHECK THE BARREL FOR OBSTRUCTIONS BEFORE LOADING AND SHOOTING.** Before checking for an obstruction, put the safety mechanism in the "S" position and open the bolt assembly and remove the percussion cap and residue from the nipple. Water, snow, mud or any other material can obstruct the barrel and cause barrel damage.
4. **USE BLACK POWDER OR PYRODEX® ONLY TO LOAD YOUR MUZZLELOADING FIREARM.** Never use even small amounts of smokeless powder, even if it is black in color. The use of any other propellant may cause injury or death to the shooter or bystanders and damage the firearm.
5. **NEVER EXCEED THE MAXIMUM RECOMMENDED POWDER CHARGE CONTAINED IN THIS BOOK.** To do so could result in injury or death to the shooter or bystanders.
6. **NEVER POUR POWDER DIRECTLY FROM A POWDER FLASK OR CONTAINER.** A sudden powder ignition from a lingering spark could cause the entire flask to explode. Use an individual charge from a powder measure when loading your rifle. Read and follow your powder manufacturer's procedures for powder storage.
7. **NEVER USE THE WRONG AMMUNITION COMPONENTS.** Only use ammunition components that exactly match the caliber markings on your firearm and are meant to be used together. Use only pure lead or Remington® brand loading components when shooting lubed conical bullets. Do not use any other lead alloys with lubed conical bullets as they may be too hard for proper and safe use in your muzzleloader.
8. **WHEN LOADING, BE CERTAIN POWDER, PATCHES AND PROJECTILES ARE IN THEIR PROPER SEQUENCE AND THAT THEY ARE COMPLETELY SEATED AGAINST ONE ANOTHER.** Serious personal injury or death can result if space is left between them. To provide a reference mark for future loadings, mark the ramrod at the muzzle once a projectile has been loaded to the proper depth. **NOTE:** Be sure to recheck the ramrod mark if you change loading components or alter the ramrod. See Picture 13 on page 15. Never attempt to shoot out a projectile that is not firmly seated against the powder charge or does not seat to the proper depth. Remove these projectiles following the instructions on pages 18 and 19.
9. **ALWAYS USE COTTON PATCHING.** The use of non-cotton patching could build up a static electric charge possibly creating a spark that could ignite the powder.
10. **NEVER POUND THE RAMROD.** Black powder and PYRODEX are impact sensitive and could ignite from impact. Keep the ramrod directly away from your face or body.
11. **KNOW THE RANGE OF YOUR FIREARM.** Muzzleloading projectiles have a range of more than one-half mile.
12. **IF THE FIREARM FAILS TO FIRE, BE PREPARED FOR A HANGFIRE.** Keep the muzzle pointed in a safe direction and wait no less than **one full minute** before opening the bolt. A spark may have reached the powder without any sound. **The rifle could fire at any moment during this minute.** If the rifle does not fire within a minute, carefully follow the directions on how to handle a misfire on pages 15 and 16.
13. **RENDER YOUR FIREARM INOPERABLE WHENEVER YOU ARE NOT SHOOTING.** Never place the percussion cap on the nipple until just before firing and remove it immediately if you do not fire. Never carry or store a loaded firearm in a building or a vehicle. Unload it by firing it into a suitable backstop before returning to your vehicle, entering a building, crossing or climbing up or down any obstacle that may prevent you from keeping full control over the firearm, such as a fallen tree, fence, treestand or slippery area. Failure to follow this rule may cause serious injury or death to the shooter or bystanders.
14. **BLACK POWDER LEAVES HEAVY CORROSIVE RESIDUES.** A thorough cleaning and lubing are absolute necessities before storage and prior to loading and shooting. Follow the cleaning instructions starting on page 19. Always carry loading and cleaning equipment with you in the field.
15. **NEVER USE THE WEATHER SHROUD FOR REPEATED SHOOTING.** It is intended for single shot usage. Always disassemble and clean the bolt assembly after shooting with the weather shroud. See page 22 for bolt assembly cleaning instructions.
16. **WARNING:** Discharging firearms in poorly ventilated areas, cleaning firearms or handling ammunition components may result in exposure to lead, a substance known to cause birth defects, reproductive harm, cancer and other serious physical injury. Have adequate ventilation at all times. Wash hands thoroughly after exposure.

WARNING: Failure to follow any of these muzzleloading safety rules may cause personal injury or death to the shooter or bystander and damage to property. Do not use a muzzleloader firearm until you fully understand and practice the Ten Commandments of Firearm Safety and the safety guidelines specific to black powder shooting, to your black powder firearm and to your black powder ammunition components. If you are unfamiliar with black powder firearms, seek professional instruction from a qualified organization such as the International Black Powder Hunting Association, National Muzzleloading Rifle Association, National Rifle Association or your State Hunter Safety program. If you have any questions about the safe use of a Remington® black powder firearm, write to us at Remington Arms Company, Inc., Consumer Services, P.O. Box 700, Madison, NC 27025-0700 or call us at 1-800-243-9700.

DON'T KEEP THIS TO YOURSELF.

Now that you're a gun owner you have the obligation to help ensure that shooting sports are safe for everyone – participants and bystanders alike. You can do that by practicing these principles of firearm safety and passing them on to others – especially new shooters. Set an example for beginners. Be a guide to their safe entry into the exciting world of shooting sports. Invest your time and patience for the love of the sport and for its future. After all, it's your love of the sport that led you to buy a new Remington.

Firearm ownership is a right and privilege. It's a right guaranteed in this nation's Constitution. It's a privilege which carries with it a personal responsibility to use your firearm in a way which will ensure your safety and the safety of others. The preservation of this right and privilege depends on the personal commitment of you and your fellow shooters to the safe and responsible use of firearms. Let the Ten Commandments of Firearm Safety outlined in the book guide you at all times. Teach and promote these rules whenever you can. Remember, firearm safety depends on you! That's the only way to really enjoy your new Remington firearm and to preserve sport shooting as we know it today.

Model 700™ ML In-Line Muzzleloading Rifle

Congratulations on your choice of a Remington. With proper care, it should give you many years of dependable use and enjoyment.

For best results, we recommend that you use **Remington Loading Components** – the components used in factory testing your firearm against our exacting function and performance standards.

PICTURE 1 This picture shows the main parts of the Remington Model 700 ML. The picture will aid in understanding the instructions in this book.

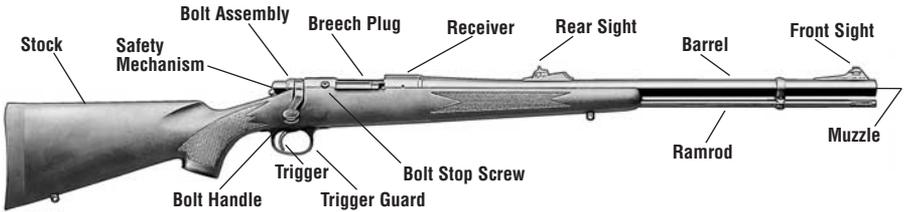

PICTURE 2 This picture shows loading components.



Firearm Safety

A person using a firearm has assumed an enormous responsibility. You must use your firearm in a way that will ensure not only your own safety, but that of others. Safe firearm handling is not a part-time or occasional requirement – it is a full-time responsibility. You **must** know how to use your firearm safely at **all** times under **all** circumstances. **Never** use any firearm without a complete understanding of how it works and how to use it safely.

This instruction book is intended to help you learn how to properly and safely use and care for your Remington® firearm. Only when you understand and can **safely practice all** of the instructions in this book, should you begin to use the firearm with live ammunition.

If you are unfamiliar with muzzleloading firearms, seek professional instruction from a qualified organization such as the International Black Powder Hunting Association, National Muzzleloading Rifle Association, National Rifle Association or your State Hunter Safety program.

If you loan or sell this firearm, this book must accompany the firearm.

Replacement books are available from Remington at no charge.

If you have any questions concerning the safe use of your Remington firearm, write to us at Remington Arms Company, Inc., Consumer Services, P.O. Box 700, Madison, NC 27025-0700.

Important Parts of the Firearm

The Safety Mechanism

The safety mechanism provides protection against accidental or unintentional discharge under normal usage when properly engaged and in good working order. The safety mechanism is not a substitute for following the rules of safe gun handling.

To engage the safety mechanism, pull the safety mechanism fully to the rear towards the 'S' position. See Picture 3.

Always put the safety mechanism in the 'S' position before handling, loading or unloading the firearm.

When you are ready to fire the firearm, push the safety mechanism forward towards the 'F' position to disengage the safety mechanism. See Picture 4.

Do not touch the trigger while moving the safety mechanism. Your fingers and all other objects should be kept outside of the trigger guard and away from the trigger until you are actually ready to fire by pulling the trigger.

Never pull the trigger when the safety mechanism is in the 'S' position.

Even when you think the safety mechanism is in the 'S' position, careless handling can cause the firearm to fire. SEE THE TEN COMMANDMENTS OF FIREARM SAFETY ON PAGE 2.

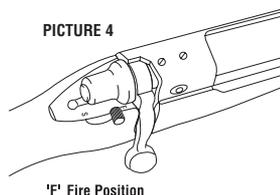
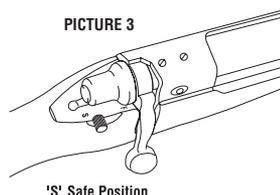

To Install Bolt Assembly

The bolt assembly houses the firing pin and mainspring.



1. Point the firearm in a safe direction.
2. Put the safety mechanism in the 'S' position.
3. Check to be sure there is no percussion cap or percussion cap residue on the nipple and there is no charge in the barrel. See instructions on using the ramrod to check for a charge in the barrel on page 6.

WARNING! If there is a charge in the barrel, do not attempt to remove it by shooting it out if you are unsure what the charge is or if you are unsure if the charge is safe. Instead, remove the charge using the instructions on pages 18 and 19.

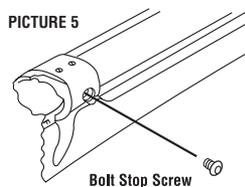

4. Remove the bolt stop screw from the receiver. See Picture 5.
5. Slide the bolt assembly into the receiver and align the firing pin head with the slot cut in the rear of the receiver. Also, align the long slot in the bolt body with the hole for the bolt stop screw in the receiver. See Picture 6.
6. Screw the bolt stop screw into the receiver until the head of the screw stops firmly against the bottom of the counterbore. (The end of the screw will be inside the slot in the bolt body.) DO NOT OVER-TIGHTEN.
7. Slide the bolt assembly fully forward into the receiver.
8. To place the bolt assembly in the closed, ready to fire position, push the bolt handle down.

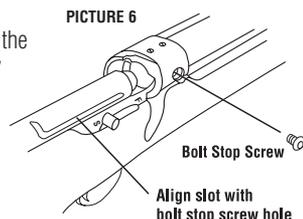

To Remove Bolt Assembly

1. Point the firearm in a safe direction.
2. Put the safety mechanism in the 'S' position. Do not touch the trigger while moving the safety mechanism.
3. Raise the bolt handle to open the bolt.
4. Check to be sure there is no percussion cap or percussion cap residue on the nipple and there is no charge in the barrel. See instructions on using the ramrod to check for a charge in the barrel on page 6.

WARNING! If there is a charge in the barrel, do not attempt to remove it by shooting it out if you are unsure what the charge is or if you are unsure if the charge is safe. Instead, remove the charge using the instructions on pages 18 and 19.

5. Remove the bolt stop screw from the receiver. Never attempt to remove the bolt stop screw with the bolt handle down.
6. Slide the bolt out of the receiver.

The Trigger Assembly

Pulling the trigger fires the firearm.

The trigger is adjusted at the factory. All adjustments to the trigger assembly and firing mechanism must be made by the factory or a REMINGTON® AUTHORIZED GUNSMITH.

WARNING! NEVER remove the trigger mechanism or make adjustments to the trigger or trigger assembly.

WARNING! NEVER put your finger on the trigger unless you are going to fire the firearm.

The Barrel

The inside of the barrel must be clean and free of obstructions.



I. TO CHECK THE INSIDE OF THE BARREL:

1. Point the firearm in a safe direction.
2. Put the safety mechanism in the 'S' position.
3. Check to be sure there is no percussion cap or percussion cap residue on the nipple and there is no charge in the barrel. See instructions on using the ramrod to check for a charge in the barrel on page 6.

WARNING! If there is a charge in the barrel, do not attempt to remove it by shooting it out if you are unsure what the charge is or if you are unsure if the charge is safe. Instead, remove the charge using the instructions on pages 18 and 19.

4. Remove the bolt assembly. See instructions on this page.
5. Remove the breech plug. See instructions on page 11.
6. Look through the inside of the barrel from the breech end to the muzzle. See Picture 1 on page 8.

II. TO REMOVE OBJECT FROM INSIDE THE BARREL:

(To remove a charge, see REMOVING A CHARGE on pages 18 and 19.)

1. Use the ramrod with extension and handle.
2. With the breech plug removed, push the ramrod through the barrel from the breech end to the muzzle to remove the object.
3. If an object cannot be easily pushed out of the barrel with a ramrod, return the firearm to the factory or a REMINGTON AUTHORIZED GUNSMITH.

WARNING! NEVER try to remove an object from the barrel by firing it out. This may cause serious damage to the firearm and injury or death to the shooter or bystanders.

III. TO CLEAN THE BARREL FOLLOW THE INSTRUCTIONS SHOWN ON PAGES 20 AND 21.

Before loading the firearm, make sure the inside of the barrel is free of dirt or other obstructions.

To Install the Breech Plug

WARNING! If the nipple is in the breech plug when you are installing it, make sure there is no percussion cap on the nipple.

1. With nothing in the barrel and a clean breech plug, apply Remington Wonder Lube® paste for black powder generously onto the breech plug threads. Avoid putting Remington Wonder Lube paste for black powder on the front face of the breech plug. See Picture 7. This will foul the powder that comes in contact with it, increasing the chances of a misfire or hangfire.

PICTURE 7
Avoid putting Remington Wonder Lube® on the front face of the Breech Plug.

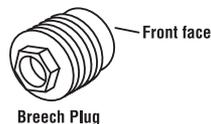

2. With the bolt assembly and bolt stop screw removed, place the breech plug in the bolt assembly clearance hole in the receiver, with the hexagon wrench flats facing rearward.
3. Slide the breech plug through the receiver until it stops against the rear of the barrel.
4. Use the hexagon end of the combination wrench provided or a standard 7/16" socket with a long extension to thread the breech plug into the rear of the barrel. Start it by hand at first to ensure it is not cross threaded.
5. Make sure the breech plug is tightened snugly and the back face of the breech plug is even with the front edge of the ejection port in the receiver. Do not over-tighten. See Picture 8.

WARNING! THE BREECH PLUG MUST BE SEATED CORRECTLY IN THE BARREL TO ENSURE THE PROPER AND SAFE OPERATION OF THE FIREARM. DO NOT ATTEMPT TO FIRE THE RIFLE if the breech plug will not thread in smoothly and tighten snugly with the **BACK FACE** of the breech plug even with the **FRONT EDGE** of the ejection port in the receiver. If the breech plug cannot be seated correctly, return the firearm to the factory or a **REMINGTON® AUTHORIZED GUNSMITH**.

To Remove the Breech Plug

WARNING: If the nipple is in the breech plug as you are removing it, make sure there is no percussion cap on the nipple.

1. Point the firearm in a safe direction.
2. Put the safety mechanism in the 'S' position.
3. Raise the bolt handle to open the bolt.
4. Check to be sure there is no percussion cap on the nipple or percussion cap residue remaining on the nipple and there is no charge in the barrel. See instructions on using the ramrod to check for a charge in the barrel on page 6.

WARNING: If there is a charge in the barrel, do not attempt to remove it by shooting it out if you are unsure what the charge is or if you are unsure if the charge is safe. Instead, remove the charge using the instructions on pages 18 and 19.

5. Remove the bolt assembly and bolt stop screw. See instructions on page 10.
6. Use the hexagon end of the combination wrench provided or a standard 7/16" socket with a long extension to remove the breech plug from the barrel.
7. If the breech plug can not be removed with reasonable force using a 7/16" socket with extension, return the firearm to the factory or a **REMINGTON AUTHORIZED GUNSMITH**.

To Install the Nipple

1. With an empty barrel and a clean nipple, apply Remington Wonder Lube® paste for black powder to the threads of the nipple. This will protect it from the highly corrosive powder residues left from shooting black powder or PYRODEX® and ensure its easy removal. Avoid putting Remington Wonder Lube paste for black powder on the front face of the nipple. This will foul the powder charge that comes in contact with it, increasing the chances of a misfire or hangfire.
2. With the breech plug installed and the bolt stop screw and bolt assembly removed, thread the nipple into the breech plug. Start threading by hand to ensure that it is not cross-threaded and then use the combination wrench. Be sure that the end of the nipple is seated snugly against the bottom of the nipple hole in the breech plug. Do not over-tighten. See Picture 9.

WARNING: THE NIPPLE MUST BE SEATED CORRECTLY IN THE BREECH PLUG TO ENSURE THE PROPER AND SAFE OPERATION OF THE FIREARM. DO NOT ATTEMPT TO FIRE THE RIFLE if the nipple cannot be seated correctly. Return the firearm to the factory or a **REMINGTON AUTHORIZED GUNSMITH**.

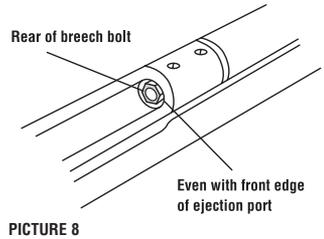

PICTURE 9

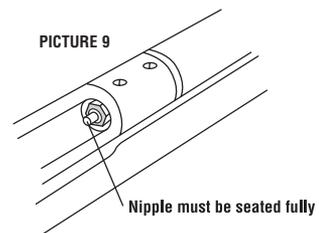

To Remove the Nipple

WARNING! Never attempt to remove the nipple with a percussion cap on it.

1. Point the firearm in a safe direction.
2. Put the safety mechanism in the 'S' position.
3. Raise the bolt handle to open the bolt.
4. Check to be sure there is no percussion cap on the nipple or percussion cap residue remaining on the nipple and there is no charge in the barrel. See instructions on using the ramrod to check for a charge in the barrel on page 6.

WARNING! If there is a charge in the barrel, do not attempt to remove it by shooting it out if you are unsure what the charge is or if you are unsure if the charge is safe. Instead, remove the charge using the instructions on pages 18 and 19.

Loading and Shooting Procedures

Use Black Powder or PYRODEX® Only

Never use modern smokeless gun powder even if it is black in color. Never use any powder other than black powder or PYRODEX in a muzzleloader. The use of any other propellant will cause serious injury or death to the shooter and bystanders and damage to the firearm.

Prior to loading and shooting the firearm, refer to the cleaning instructions starting on page 19. It is essential your gun is clean for proper safety, function and accuracy.

Black Powder and PYRODEX

Black powder is the name that identifies the type of powder that is safe to use in muzzleloading firearms and DOES NOT REFER TO ALL POWDERS THAT ARE BLACK IN COLOR. Some modern smokeless powders are black in color but are designed to be used only in modern centerfire cartridges and shotgun shells. Be sure to identify the powder as a type to be used in muzzleloading firearms by the name and NOT THE COLOR.

PYRODEX is a black powder replica that is intended for use in percussion type muzzleloading firearms and is the ONLY black powder replica that is safe to use in this Remington® Model 700™ ML Muzzleloading rifle.

PYRODEX is intended to be used as a volume-to-volume replacement for black powder and will produce similar velocities and pressures as the same **volume** of the appropriate granulation of black powder. Thus, a volumetric powder measure that is set to measure 100 grains of black powder can be filled with PYRODEX instead to achieve similar results. This measure will only contain approximately 80 grains of PYRODEX. PYRODEX is used on a volume-to-volume replacement basis and NOT ON A WEIGHT-TO-WEIGHT BASIS.

WARNING! The use of ANY quantity of smokeless gun powder in this muzzle-loading firearm will produce dangerously high pressures which WILL result in serious injury or death to the shooter and bystanders, and damage to the firearm.

Black powder is available in four powder grain sizes which are identified by a series of 'F's' marked on the container.

2F or FFg – Used in .45 caliber or larger guns. This is the granulation recommended for use in this muzzleloading rifle. Do not use any other granulation.

PYRODEX is available in two grain sizes identified by an 'RS' or 'P' on the container.

PYRODEX RS – Stands for Rifle and Shotgun powder and is designed for use in all calibers of percussion type muzzleloading rifles and shotguns. **PYRODEX RS is recommended for use in this muzzleloading rifle. Do not use any other designation.**

WARNING! ONLY 2F OR FFg black powder or PYRODEX RS should be used in this rifle.

Never exceed the maximum quantity of powder for a particular projectile in the loading charts on pages 16 and 17.

Failure to comply with any of these warnings could result in serious personal injury or death to the shooter or bystanders and damage to the firearm.

Selecting the Projectile

NOTE: It is recommended that for safety and performance, only Remington® brand loading components made to Remington's exacting standards, be used in the Remington Model 700™ ML muzzleloading rifle.

There are three projectile types that can be fired safely and accurately in this rifle. They are the sabot conical, the lubed conical and the patched round ball. See Picture 10.

PICTURE 10



Saboted Conical

The Saboted Conical: With a sabot projectile, the sabot engages the barrel rifling (rather than the projectile itself) to provide a gas seal as well as to provide the rotation necessary to stabilize the projectile in flight.

A smaller-than-bore-size projectile can be used with a sabot resulting in higher muzzle velocity, flatter trajectory.

The sabot is self-lubricating, so there is no need to use additional lubrication when shooting sabot conical projectiles.

Never use a patch with a conical projectile that is to be used with a sabot.



Lubed Conical

The Lubed Conical: With the lubed conical, the projectile itself engages the rifling to provide a gas seal as well as the rotation necessary to stabilize the projectile in flight.

Never use a patch or sabot with a lubed conical projectile.

Always use lubricant with any projectile that is not to be used with a sabot.

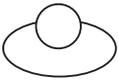

Patched Round Ball

The Patched Round Ball: With a patched round ball, the lubed cloth patch serves the same purpose as the sabot does with the sabot conical projectile type. It engages the rifling to provide a gas seal as well as the rotation necessary to stabilize the ball in flight.

WARNING: The patch should be well lubricated and made of cotton to avoid building a static electric charge in the barrel as the projectile is being seated on the powder charge. A non-cotton patch could create a spark and ignite the powder charge causing serious injury or death to the shooter or bystanders.

Remington Wonder Wads: The Remington Wonder Wad™ can be used with any of the three types of projectiles that can be used in this firearm. It is to be placed between the powder and projectile in the barrel. It acts as a secondary gas seal and expands to fill the bore and grooves in the barrel as the pressure builds behind the wad and the projectile. This reduces gas blow-by and helps improve velocity and accuracy. In addition, the Remington Wonder Wad helps clean and lubricate the barrel as it is being loaded as well as upon firing. As a result, more shots can be fired before the barrel must be cleaned.

WARNING: Except for the sabot and cotton patch, the Remington Wonder Wad is the only approved loading component to go between the projectile and powder.

Never use a jacketed bullet without a sabot in this muzzleloading rifle. Only pure lead or Remington brand lubed projectiles, specifically designed for muzzleloading, are meant to be used without a sabot.

Never use a sabot with a round ball. The sabot is not designed for a round ball and could easily separate from the powder charge creating a dangerous air gap.

Be absolutely certain that loading components are used only as they were intended to be used and are properly used together.

Loading the Powder and Projectile

Loading the Remington Model 700 ML consists of three steps. These steps are:

1. Load the Powder.
2. Load the Projectile.
3. Place the Percussion Cap on the Nipple.

Before Loading Make Sure:

1. The firearm is in good working order.
2. The firearm is pointed in a safe direction.
3. The safety mechanism is in the 'S' position. See page 9.
4. The bolt assembly is in the open position. See page 9.
5. There is no percussion cap on the nipple or percussion cap residue on the nipple.
6. The firearm is not already loaded. See page 6.
7. The barrel is free from obstructions. See page 10
8. The breech plug is seated in the barrel. See pages 10 and 11.
9. The nipple is seated in the breech plug. See page 11.
10. The flash hole through the nipple is clear.
11. You are wearing ear and eye protection.
12. You are in a place that is safe to shoot.
13. You are using only the correct loading components for this rifle.

I. LOADING THE POWDER

WARNING: Do not attempt to load the firearm until you have read and understand this book in its entirety and all 13 of the conditions listed here on this page have been met.

1. Using the ramrod with extension handle and cleaning jag, swab the bore to the breech plug with a cleaning patch that has been saturated with Remington® All-Natural Bore Cleaner to remove any debris or fouling that may have accumulated in the bore while the rifle was in storage.
2. Swab the bore with cleaning patches until the patches come out clean and dry.
3. Swab the bore with a cleaning patch lubed with Remington Wonder Lube® paste for black powder.
4. Point the firearm in a safe direction and fire at least two percussion caps to make sure the flash hole through the nipple is clear and dry. Residual bore cleaner at the breech could saturate the powder and increase the possibility of a misfire or hangfire.

WARNING: Wait at least one full minute after firing the last round or percussion cap before pouring powder into the bore to allow time for any residual sparks to be extinguished.

5. Place the butt of the rifle on a firm, stable surface with the muzzle pointed up and well away from your body.
Treat the firearm as if it could go off at any time.
6. Use an individual powder measure to pour the correct amount of powder into the bore.

WARNING: Make sure you are using 2F or FFg black powder or PYRODEX® RS only.

Never use ANY quantity of any other powder.

Never pour powder directly into the muzzle from a powder flask or container. A lingering spark could ignite the entire container of powder. Always use an individual charge measure.

Never exceed the maximum charge listed on pages 16 and 17.

NEVER USE CENTERFIRE POWDER CHARGING EQUIPMENT FOR BLACK POWDER.

7. Keep the muzzle pointed up and away from your body at all times to keep the powder in the bottom of the barrel and to avoid accidents or injuries.
8. Proceed to load the projectile.

II. LOADING THE PROJECTILE

WARNING: Do not attempt to load the firearm until you have read and understand this book in its entirety and all 13 of the conditions listed under "BEFORE LOADING MAKE SURE" at the top of this page.

1. Keep the butt of the rifle on a firm, stable surface with the muzzle pointed up and away from your body.
2. If you choose to use a Remington Wonder Wad,™ place it evenly on the muzzle so it plugs the entire bore. Push the wad into the bore a short distance with a short starter.

3. Load ONE of the projectiles as follows:

- To load a Saboted Conical, firmly seat the projectile in the sabot and push the sabot and projectile into the bore by hand. See Picture 11.
- To load a Lubed Conical, push the lubricated projectile by hand into the bore. See Picture 11.
- To load a Patched Round Ball, lay a lubricated patch evenly over the muzzle and push a round ball into the center of the patch and into the bore by hand. See Picture 11.

4. Use the ball end of a short starter to start the projectile and align it with the bore. Push the projectile approximately six inches into the bore with the shaft of the short starter.

5. Use the ramrod to seat the projectile (and Remington® Wonder Wad™ if used) firmly on the powder charge. See Picture 12.

WARNING: Do not pound on the ramrod to seat the projectile. Black powder and PYRODEX® are impact sensitive and may ignite from impact. The impact may also deform the projectile, adversely affecting accuracy.

6. Be sure the projectile is firmly seated on the powder charge so there isn't a gap between the powder and the projectile. To provide a reference mark for future loadings, mark the ramrod at the muzzle once a projectile has been loaded to the proper depth. See Picture 13.

NOTE: Be sure to recheck the ramrod mark if you change loading components or alter the ramrod.

7. Remove the ramrod from the barrel and replace it in the stock under the barrel.

III. PLACING THE PERCUSSION CAP

NOTE: Only use caps intended for use with the nipple installed in the firearm.

1. Place a percussion cap on the nipple.
2. Slide the bolt handle forward and put the bolt handle down.

NOW THE RIFLE IS LOADED.

To make the rifle ready to fire, put the safety mechanism in the 'F' position.

NOW THE RIFLE IS READY TO FIRE.

Pulling the trigger fires the rifle.

WARNING: Wait at least one full minute after firing the last round before pouring powder into the bore to allow time for any residual sparks to be extinguished.

How to Handle a Misfire and Hangfire

The Remington Model 700™ has been designed to fire the instant that you pull the trigger. If, however, the powder and/or percussion cap are damp, a hangfire or misfire may occur. A hangfire occurs when the rifle fires up to several seconds after the trigger is pulled. A misfire occurs when a loaded rifle does not fire when the trigger is pulled.

In the case of a misfire or hangfire, proceed as follows:

1. Keep the rifle pointed in a safe direction for at least one full minute with the bolt in the closed position.
BE PREPARED FOR THE RIFLE TO FIRE AT ANY INSTANT.
2. After no less than one minute open the bolt assembly, keeping the rifle pointed in a safe direction.
3. Put the safety mechanism in the 'S' position. See page 9.
4. Remove the percussion cap from the nipple and use a nipple pick to ensure that the flash hole through the nipple is clear.
5. Place a new percussion cap on the nipple.
6. Close the bolt assembly.

PICTURE 11

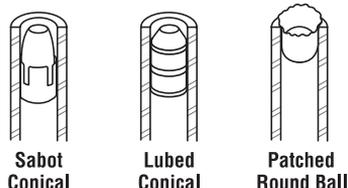

PICTURE 12

Projectile seated firmly on powder charge

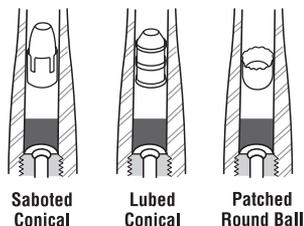

PICTURE 13

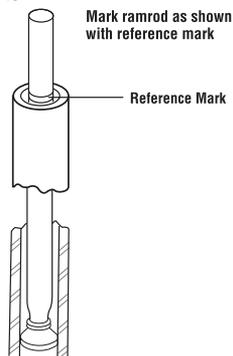

7. Aim at the target.
8. Put the safety mechanism in the 'F' position and fire. See page 9.
9. If the rifle still does not fire, repeat steps 1 through 8 several more times.
10. If the rifle still does not fire, the charge must be removed manually. See REMOVING A CHARGE on pages 18 and 19.

Suggested Loading Data

This data was compiled from testing done by Remington® Arms using both .50 and .54 caliber Remington projectiles in the Model 700™ ML rifle. The Model 700 ML barrels are rifled with 1 in 28" twist in both .50 and .54 caliber. All testing was done with 2F or FFg black powder.

WARNING: NEVER EXCEED THE MAXIMUM CHARGE WEIGHT LISTED FOR THE PROJECTILE YOU ARE USING. NEVER SUBSTITUTE ANY QUANTITY OF ALTERNATE POWDER TYPE OR GRANULATION. Failing to adhere to these maximum charge weights or substituting any powder type or granulation could result in serious personal injury or death to the shooter or bystanders and damage to the firearm.

The charge weights listed are the nominal range and maximum charge weights for the given projectile.

The nominal suggested range of charge weight produces the best combination of accuracy and velocity. It is done by starting at the lower charge weight listed in the nominal range and increasing in 5 grain increments until an optimum load is achieved. An optimum load is one which produces the best accuracy.

WARNING: Do not exceed this charge weight. To do so may result in serious personal injury or death to the shooter or bystanders and damage to the firearm.

| Projectile | Grain Weight | Black Powder Charge (Grains) | Muzzle Velocity (Feet Per Second) | Muzzle Energy (Foot Pounds) |
|---|--------------|------------------------------|-----------------------------------|-----------------------------|
| .50 CALIBER SABOTED PROJECTILES | | | | |
| Core-Lokt® JHP | 275 | 90 grs. FFg | 1450 f.p.s. | 1284 ft.-lbs. |
| | | 100 grs. FFg | 1505 f.p.s. | 1383 ft.-lbs. |
| | | 110 grs. FFg | 1565 f.p.s. | 1495 ft.-lbs. |
| | | 120 grs. FFg Max. | 1610 f.p.s. | 1583 ft.-lbs. |
| Premier® Copper Solid | 289 | 90 grs. FFg | 1450 f.p.s. | 1384 ft.-lbs. |
| | | 100 grs. FFg | 1515 f.p.s. | 1471 ft.-lbs. |
| | | 110 grs. FFg | 1563 f.p.s. | 1566 ft.-lbs. |
| | | 120 grs. FFg Max. | 1635 f.p.s. | 1658 ft.-lbs. |
| Copper-Lokt® JHP | 303 | 90 grs. FFg | 1397 f.p.s. | 1313 ft.-lbs. |
| | | 100 grs. FFg | 1480 f.p.s. | 1474 ft.-lbs. |
| | | 110 grs. FFg | 1515 f.p.s. | 1544 ft.-lbs. |
| | | 120 grs. FFg Max. | 1570 f.p.s. | 1658 ft.-lbs. |
| .50 CALIBER LEAD LUBED CONICALS | | | | |
| Gamemaster™ Flat Base Hollow Point | 365 | 90 grs. FFg | 1350 f.p.s. | 1477 ft.-lbs. |
| | | 100 grs. FFg | 1405 f.p.s. | 1600 ft.-lbs. |
| | | 110 grs. FFg | 1470 f.p.s. | 1751 ft.-lbs. |
| | | 120 grs. FFg Max. | 1525 f.p.s. | 1885 ft.-lbs. |
| Gamemaster™ Flat Base Solid Point | 385 | 90 grs. FFg | 1315 f.p.s. | 1479 ft.-lbs. |
| | | 100 grs. FFg | 1370 f.p.s. | 1605 ft.-lbs. |
| | | 110 grs. FFg | 1435 f.p.s. | 1760 ft.-lbs. |
| | | 120 grs. FFg Max. | 1470 f.p.s. | 1847 ft.-lbs. |
| .50 CALIBER ROUND BALL | | | | |
| Premier® Golden™ Lead .490" Dia. Ball | 179 | 80 grs. FFg | 1650 f.p.s. | 1082 ft.-lbs. |
| | | 90 grs. FFg | 1750 f.p.s. | 1197 ft.-lbs. |
| | | 100 grs. FFg | 1840 f.p.s. | 1346 ft.-lbs. |
| | | 110 grs. FFg Max. | 2050 f.p.s. | 1670 ft.-lbs. |

| Projectile | Grain Weight | Black Powder Charge (Grains) | Muzzle Velocity (Feet Per Second) | Muzzle Energy (Foot Pounds) |
|--|--------------|------------------------------|-----------------------------------|-----------------------------|
| .54 CALIBER SABOTED PROJECTILES | | | | |
| Core-Lokt® | | 90 grs. FFg | 1410 f.p.s. | 1337 ft.-lbs. |
| JHP | 303 | 100 grs. FFg | 1460 f.p.s. | 1435 ft.-lbs. |
| | | 110 grs. FFg | 1510 f.p.s. | 1534 ft.-lbs. |
| | | 120 grs. FFg Max. | 1565 f.p.s. | 1648 ft.-lbs. |
| .54 CALIBER LEAD LUBED CONICALS | | | | |
| Gamemaster™ | | 90 grs. FFg | 1235 f.p.s. | 1355 ft.-lbs. |
| Flat Base | 400 | 100 grs. FFg | 1290 f.p.s. | 1478 ft.-lbs. |
| Hollow Point | | 110 grs. FFg | 1355 f.p.s. | 1631 ft.-lbs. |
| | | 120 grs. FFg Max. | 1410 f.p.s. | 1766 ft.-lbs. |
| .54 CALIBER ROUND BALL | | | | |
| Premier® | | 90 grs. FFg | 1680 f.p.s. | 1416 ft.-lbs. |
| Golden™ Lead | 226 | 100 grs. FFg | 1760 f.p.s. | 1534 ft.-lbs. |
| .530" Dia. Ball | | 110 grs. FFg | 1830 f.p.s. | 1680 ft.-lbs. |
| | | 120 grs. FFg Max. | 1960 f.p.s. | 1928 ft.-lbs. |

To Adjust Sights

This Remington® Model 700™ ML is equipped with a fully adjustable rear sight. It can be adjusted for both windage (left to right) and elevation (up and down).

TO ADJUST THE REAR SIGHT:

Move the rear sight slide for elevation adjustment. Move the slide or aperture in the same direction as you need the point of impact on the target to move. See Picture 14 and the information table.

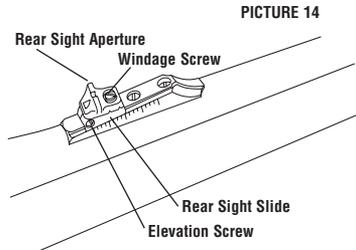

PICTURE 14

TELESCOPIC SIGHTS:

The top of the receiver has holes for the installation of telescopic sights. The same Model 700 two-piece scope mounts that fit the centerfire rifles will fit on this muzzleloader. Model 700 Short Action one-piece scope mounts will also fit.

NOTE: The use of telescopic sights are **illegal** in some areas during the big-game muzzleloading season. Be sure to check the regulations in the area you will be hunting before installing the scope.

How to Use the Weather Shroud

This Remington Model 700 ML is shipped with an optional weather shroud. The shroud can be placed on the end of the bolt assembly to protect the percussion cap from inclement weather. This shroud will decrease the possibility of the percussion cap getting damp which will decrease the chance of a misfire or hangfire.

NOTE: In some areas, the use of the weather shroud is **illegal** during the muzzleloading season for big game. Some areas require that the ignition source be exposed to the elements (open breech) prior to firing. Before installing the weather shroud, check the regulations in the area you will be hunting.

The weather shroud is intended only for use while hunting or shooting in inclement weather. It should not be used when target shooting or sighting in the rifle. Extended use of the weather shroud while shooting could cause accumulation of fouling in the bolt assembly. This fouling can result in an interference between the firing pin and bolt body. Always disassemble and clean the bolt assembly after shooting with the weather shroud. See page 22 for bolt cleaning instructions.

| POSITION ON TARGET | ADJUSTMENTS |
|-------------------------------|--|
| Bullet hits above the center. | <ol style="list-style-type: none"> Loosen the elevation screw on the rear sight. Slide the rear sight down (backward) on the ramp. Tighten the elevation screw. |
| Bullet hits below the center. | <ol style="list-style-type: none"> Loosen the elevation screw on the rear sight. Slide the rear sight up (forward) on the ramp. Tighten the elevation screw. |
| Bullet hits to the left. | <ol style="list-style-type: none"> Loosen the windage screw on the rear sight. Slide the rear sight aperture to the right. Tighten the windage screw. |
| Bullet hits to the right. | <ol style="list-style-type: none"> Loosen the windage screw on the rear sight. Slide the rear sight aperture to the left. Tighten the windage screw. |

Installing the Weather Shroud

The weather shroud has a gas escape hole to vent blowback gasses to the environment. To work properly, it must be aligned with the ejection port opening when the bolt is in the closed position. See Picture 15.

1. Close the bolt and make a pencil mark on the bolt approximately 1/8 inch from the bottom on the ejection port opening. See Picture 16.
2. Remove the bolt assembly. Align the vent hole with the pencil mark and push the shroud on to the end of the bolt until the shroud is seated against the step on the bolt. See Picture 17.
3. Reinstall the bolt assembly and verify that the vent hole is properly positioned. See Picture 18.

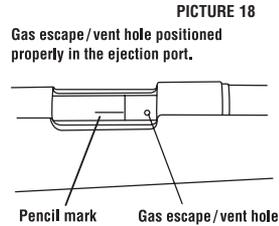
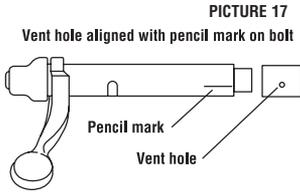
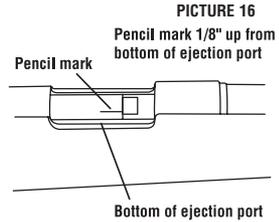
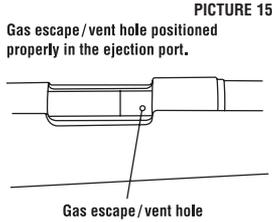

Removing a Charge and Projectile (Unloading)

Under normal conditions a muzzleloading firearm is unloaded by simply firing it into a safe and suitable backstop. There are however, three conditions which may occur that will require the rifle to be unloaded manually.

These are:

1. A misfire or failure to fire.

WARNING: FOR A MISFIRE OR FAILURE TO FIRE, WAIT AT LEAST ONE MINUTE WITH THE RIFLE POINTED IN A SAFE DIRECTION. A LINGERING SPARK SMOLDERING IN THE POWDER COULD FIRE THE RIFLE AT ANY MOMENT.

2. Powder fouling or other circumstances causing the projectile to become lodged partially down the barrel after firing.
3. The projectile is not firmly seated against the powder charge and cannot be made to do so with normal ramrod pressure.

If any of these situations arise, the projectile must be removed from the barrel as follows:

1. Keeping the muzzle pointed in a safe direction, put the safety mechanism to the 'S' position, open the bolt and remove the percussion cap from the nipple. Be sure there is no percussion cap residue remaining on the nipple.
2. Remove the bolt assembly. See page 10.
3. Turn the rifle upside down so that the trigger guard is up and the muzzle is pointed in a safe direction.
4. Remove the three screws, see Picture 19, and remove the barreled action from the stock.
5. Use the nipple pick to clear the nipple.
6. Submerge the action in a pail of CLEAN water, (hot water is recommended), with the muzzle pointed up, also fill the bore with water so that it is level with the muzzle. Let stand for a minimum of 30 minutes. Be sure that the breech section of the action is submerged to a depth of at least 12 inches so that water can saturate the powder charge through the nipple. Wait no less than 30 minutes. The powder charge will then be deactivated.

NOTE: THE POWDER MUST REMAIN SATURATED TO BE DEACTIVATED. SATURATED POWDER WILL NOT IGNITE. IF THERE HAS BEEN A DELAY AFTER STEP 7 AND YOU ARE UNSURE IF THE POWDER IS STILL SATURATED, REPEAT STEP 6.

WARNING: NEVER ATTEMPT TO REMOVE A PROJECTILE FROM THE BORE UNTIL THE POWDER HAS BEEN DEACTIVATED.

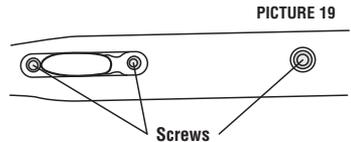

7. Remove the action from the water and pour the water from the bore.
8. Remove the breech plug and proceed to step 9. If the breech plug cannot be removed, attach a screw type bullet puller to the ramrod. Keep the ramrod directed away from your face and body while attempting to remove the projectile. Insert the ramrod with the attached bullet puller into the muzzle and twist the bullet puller into the bullet.

NOTE: Considerable force may be necessary to fully engage the bullet puller into the bullet.

Carefully pull the projectile out of the muzzle and wash the remaining saturated powder from the barrel. Omit steps 9 and 10 and go directly to step 11.

9. Thread the cleaning tube into the breech plug threads.
 10. Keep the ramrod directed away from your face and body while removing the projectile and charge. Insert the ramrod, with extension and handle, from the muzzle and push the projectile, along with any remaining saturated powder, through the cleaning tube. If the projectile and charge cannot be moved rearward, remove the cleaning tube from the breech bolt threads and wash away the saturated powder from behind the projectile. Rethread the cleaning tube into the breech. Again, keeping the ramrod directed away from your face and body, insert the ramrod with extension and handle through the cleaning tube and gently push the projectile through the barrel and out the muzzle.
 11. Clean and lubricate the rifle as explained in the cleaning instructions beginning on this page.
- WARNING: AN IMPROPERLY CLEANED AND LUBRICATED RIFLE MAY BE DANGEROUS AND COULD RESULT IN AN ACCIDENTAL DISCHARGE AND SERIOUS INJURY OR DEATH TO THE SHOOTER OR BYSTANDERS.**
12. Reassemble the firearm.

Cleaning Instructions

Black powder and PYRODEX® are very corrosive. Failure to clean and lubricate your firearm will damage it and impair its function. Your firearm should receive a thorough cleaning and lubrication each time that it is shot or it is to be stored for more than a week.

WARNING: BE SURE THAT YOUR RIFLE IS UNLOADED PRIOR TO CLEANING. SEE PAGE 5. ATTEMPTING TO CLEAN A LOADED OR PRIMED FIREARM CAN CAUSE INJURY OR DEATH TO THE SHOOTER OR BYSTANDERS. See pages 18 and 19 to unload the firearm.

Periodic cleaning of the bore may be required during prolonged shooting sessions. The bore should be cleaned if the projectile becomes difficult to load and seat over the powder or if accuracy begins to degrade.

See the *procedure* for **FIELD CLEANING** on page 22 for cleaning between shots.

Use only Remington® All-Natural Bore Cleaner to clean your bore and use Remington Wonder Lube® paste for black powder to preserve and condition your bore. Use only Remington Rem™ Oil to lubricate your trigger and bolt assemblies. Use of other products is not recommended.

Prior to loading and shooting your firearm, it is necessary to thoroughly clean the bore to remove any residual oils that may cause the powder to foul and reduce accuracy. Using Remington All-Natural Bore Cleaner and cotton patches, repeat steps 9-16 on page 20, until the patches are visibly clean **before you ever shoot your rifle**. In order to achieve desired accuracy it is necessary to “season” or break-in the barrel. This is accomplished by the initial cleaning, followed by shooting approximately ten (10) consecutive rounds (preferably lead balls or conicals) and repeating the cleaning steps 9-16 and again shooting ten (10) to twenty (20) rounds and again cleaning. The group sizes achieved by this process will decrease as more shooting, followed by cleaning and lubing of your bore, is done. Do not be discouraged if your initial group sizes are larger than expected.

Thorough Cleaning

TO CLEAN THE BARREL, BREECH PLUG AND NIPPLE:

1. Keeping the muzzle pointed in a safe direction, put the safety mechanism to the 'S' position, open the bolt and be sure there is no percussion cap or percussion cap residue remaining on the nipple.
2. Use the ramrod to be sure there is no charge in the barrel. See instructions on page 6.

WARNING: If there is a charge in the barrel, do not attempt to remove it by shooting it out if you are unsure what the charge is or if you are unsure if the charge is safe. Instead, remove the charge using the instructions on pages 18 and 19.

3. Remove the bolt assembly. See page 10.
4. Remove the nipple. See page 12.
5. Remove the breech plug. See page 11.
6. Soak the nipple and breech plug in Remington® All-Natural Bore Cleaner.
7. Using a small brush and Remington All-Natural Bore Cleaner, clean the breech plug threads in the rear of the barrel thoroughly. Use a cleaning patch or clean cloth to wipe the breech plug threads clean of all residue.
8. Insert the bore cleaning tube through the receiver and thread it into the breech plug threads by hand only. This is required to protect the breech plug threads and trigger assembly from fouling and debris.

WARNING: Fouling and debris from the bore may fall into the trigger assembly if the bore cleaning tube is not used. This could impair the function of the trigger assembly and may result in serious personal injuries or death to the shooter or bystanders.

9. Attach the cleaning jag to the ramrod. Assemble the ramrod extension and handle and place a cleaning patch soaked with Remington All-Natural Bore Cleaner evenly over the cleaning jag.
10. Insert the jag into the bore cleaning tube and push it firmly into the barrel from the breech. Swab the bore with short strokes for best results. Push the patch through the barrel and remove the cleaning patch at the muzzle.
11. Using the same method, push a dry patch through the bore.
12. Repeat steps 9-11 until the dry patch is clean.
13. Place a cleaning patch with Remington Wonder Lube® paste for black powder evenly over the jag and push it into the bore from the breech. Swab the bore with short strokes to uniformly apply the paste.
14. Repeat step 13 several times to properly condition and preserve the bore.
15. Thoroughly clean and dry the breech plug and nipple.
16. Sparingly apply Remington Wonder Lube paste for black powder on the threads of the breech plug and nipple.

NOTE: Avoid putting Remington Wonder Lube for black powder on the front face of the breech plug and nipple and in the flash hole of the nipple. Excess Remington Wonder Lube for black powder may foul the powder charge and possibly cause a misfire or hangfire.

17. Reinstall the breech plug and the nipple. See pages 10 and 11.
18. Wipe the exterior of the barrel and receiver with a cloth treated with Remington Wonder Lube for black powder.

ALTERNATE METHOD OF CLEANING THE BARREL:

1. Keeping the muzzle pointed in a safe direction, put the safety mechanism to the 'S' position, open the bolt and be sure there is no percussion cap or percussion cap residue remaining on the nipple.
2. Use the ramrod to ensure there is no charge in the barrel. See page 6.

WARNING: If there is a charge in the barrel, do not attempt to remove it by shooting it out if you are unsure what the charge is or if you are unsure if the charge is safe. Instead, remove the charge using the instructions on pages 18 and 19.

3. Remove the bolt assembly. See page 10.
4. Remove the nipple. See page 12.
5. Remove the breech plug. See page 11.

6. Insert the bore cleaning tube into the receiver and against the breech plug threads. Do not thread this tube into the barrel.
7. Attach a bore mop to the ramrod with the extension and handle assembled and insert it through the bore cleaning tube and into the barrel.
8. Place the muzzle in clean, hot water and pull the bore mop back through the barrel into the bore cleaning tube. This action will pull clean water through the bore and breech plug threads.
9. Repeat step 8 several times swabbing the bore with short strokes until the barrel and breech plug threads are clean.
10. Thread the bore cleaning tube into the breech plug threads and remove the bore mop.
11. Place a cleaning patch with Remington® Wonder Lube® paste for black powder evenly over the jag and push it into the bore from the breech. Swab the bore with short strokes to uniformly apply the paste.
12. Repeat step 11 several times to properly condition and preserve the bore.
13. Thoroughly clean and dry the breech plug and nipple.
14. Sparingly apply Remington Wonder Lube paste for black powder on the threads of the breech plug and nipple.

NOTE: Avoid putting Remington Wonder Lube for black powder on the front face of the breech plug and nipple and in the flash hole of the nipple. Excess Remington Wonder Lube for black powder may foul the powder charge and possibly cause a misfire or hangfire.

15. Reinstall the breech plug and the nipple. See pages 10 and 11.
16. Wipe the exterior of the barrel and receiver with a cloth treated with Remington Wonder Lube for black powder.

TO CLEAN THE RECEIVER AND TRIGGER ASSEMBLY:

1. Keeping the muzzle pointed in a safe direction, put the safety mechanism to the 'S' position, open the bolt and be sure there is no percussion cap or percussion cap residue remaining on the nipple.
2. Use the ramrod to be sure there is no charge in the barrel. See page 6.

WARNING: If there is a charge in the barrel, do not attempt to remove it by shooting it out if you are unsure what the charge is or if you are unsure if the charge is safe. Instead, remove the charge using the instructions on pages 18 and 19.

3. Remove the bolt assembly. See page 10.
4. Turn the rifle upside down.
5. Remove the three screws and remove the barreled action from the stock. See Picture 20.
6. Spray the four points of the trigger assembly with Rem™ Oil as shown. See Picture 21. Let stand for 15 minutes. Spray again to wash off the components. Shake off excess lubricant.

NOTE: Prevent the Rem™ Oil from entering the barrel by installing the breech plug and nipple. The petroleum base lubricant will break down the protective coating of Remington Wonder Lube paste for black powder in the barrel and increase the barrel fouling after shooting.

7. Wipe away powder fouling in the receiver with a cloth containing Remington All-Natural Bore Cleaner.
8. Wipe down the exterior of the receiver and barrel with a cloth treated with Remington Wonder Lube paste for black powder.

WARNING: Do not apply Remington Wonder Lube paste for black powder to any part of the trigger assembly. The trigger assembly and the bolt assembly are the only components of your rifle that require cleaning with Rem™ Oil only. The use of a non-recommended lubricant could cause serious function problems, possibly leading to accidental firing.

9. Replace the barreled action in the stock and reinstall the three screws. See Picture 20.

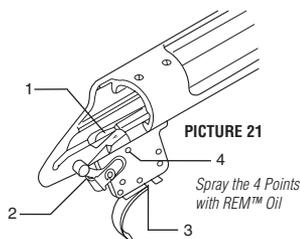
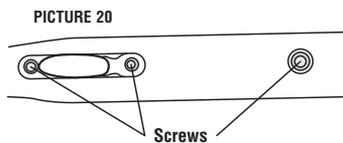

To Clean the Bolt Assembly

TO DISASSEMBLE THE BOLT ASSEMBLY:

1. Remove the bolt assembly from the firearm. See page 10.
2. Pull the bolt assembly away from the firing pin assembly by hooking the notch on the firing pin head over a metal edge and pulling. See Picture 22. Insert a coin into the slot that will become visible in the side of the firing pin head.
3. Holding the bolt assembly, unscrew the firing pin assembly and slide it out of the bolt body.

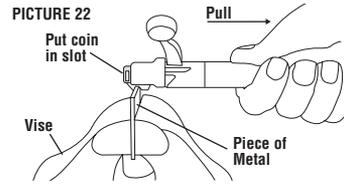

CAUTION: Clean the firing pin assembly as a unit. No further disassembly is required.

4. Clean all parts with Remington® All-Natural Bore Cleaner and dry with a clean cloth.
5. Apply a light coat of Rem™ Oil to all parts.

NOTE: The trigger assembly and bolt assembly should be lubricated with Rem™ Oil instead of Remington Wonder Lube® paste for black powder. The use of a non-recommended lubricant could cause serious function problems, possibly leading to accidental firing.

TO ASSEMBLE THE BOLT ASSEMBLY:

1. Slide the firing pin assembly into the rear of the bolt assembly.
2. Tighten the firing pin assembly by hand only.
3. Pull the coin from the slot in the firing pin head.
4. Align the firing pin head with the small notch in the rear of the bolt assembly. The bolt is now cocked. See Picture 23.
5. Assemble the bolt assembly in the receiver. See instructions on page 9.

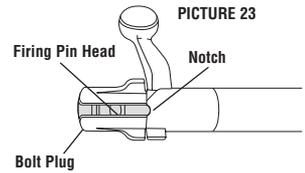

Bolt in Cocked Position

Field Cleaning

WARNING: BE SURE THAT YOUR RIFLE IS UNLOADED PRIOR TO CLEANING. SEE PAGE 6. ATTEMPTING TO CLEAN A LOADED OR PRIMED FIREARM CAN CAUSE INJURY OR DEATH TO THE SHOOTER OR BYSTANDERS.

See pages 18 and 19 to unload the firearm.

Follow this procedure to clean your muzzleloader in the field:

1. Keeping the muzzle pointed in a safe direction, put the safety mechanism in the 'S' position, open the bolt and be sure there is no percussion cap or percussion cap residue remaining on the nipple.
2. Use the ramrod to ensure there is no charge in the barrel. See page 6.

WARNING: If there is a charge in the barrel, do not attempt to remove it by shooting it out if you are unsure what the charge is or if you are unsure if the charge is safe. Instead, remove the charge using the instructions on pages 18 and 19.

3. Attach the cleaning jag to the ramrod. Assemble the ramrod extension and handle and place a cleaning patch soaked with Remington All-Natural Bore Cleaner evenly over cleaning jag.
4. Push the cleaning jag into the barrel at the muzzle and swab the bore with short strokes until the jag reaches the breech plug. Remove the ramrod and remove the cleaning patch from the jag.
5. Repeat step 4 with a dry patch.
6. Repeat steps 3-5 until the dry patch remains clean.
7. Place a cleaning patch with Remington Wonder Lube paste for black powder evenly over the jag and push it into the bore from the breech. Swab the bore with short strokes to uniformly apply the paste.
8. Repeat step 7 several times to properly condition and preserve the bore.
9. Point the firearm in a safe direction and fire at least two percussion caps to make sure the flash hole through the nipple is clear and dry. Residual bore cleaner at the breech could saturate the powder and increase the possibility of a misfire or hangfire.

WARNING: Wait at least one full minute after firing the last percussion cap before pouring powder into the bore to allow time for any residual sparks to be extinguished.

How to Obtain Parts and Service From Remington.®

TO ORDER PARTS:

Many Remington® Dealers and Authorized Repair Centers carry a full line of parts. Please check with them first before ordering parts.

To expedite your PARTS order or request REPAIR SERVICE visit our web site at www.remington.com. Detailed instructions are provided along with parts and/or service order forms. You may also reach Remington by calling our toll free customer service number, 1-800-243-9700, Mon.-Fri., 9:00 AM-5:00 PM Eastern time.

1. Fax completed order form (from the web site) to 1-336-548-7801.
2. To order by phone without the order form call 1-800-243-9700.

Please have the following information ready before you call.

- Firearm model and serial number.
- Part description and quantity. Part descriptions can be found on the parts listing page in this manual.
- Your complete mailing address (P.O. Box and Street Address) including zip code, telephone number and e-mail address.
- Method of payment: Mastercard, Visa, Amex or Discover card number and expiration date. Prepayment may be made by check or money order. A quote may be made to you over the phone. (Sorry, no C.O.D.s.)

WARNING! USE ONLY REMINGTON PARTS IN REMINGTON FIREARMS.

NOTE: SOME PARTS MAY BE RESTRICTED. See parts list for details. Owner's manuals/instruction books may be requested via our web site at: www.remington.com or by calling 1-800-243-9700.

REPAIR SERVICES

1. To locate the Remington Authorized Repair Center nearest you visit our web site at www.remington.com and use our Repair Service Locator. If you need additional on-line assistance, e-mail us at info@remington.com to obtain a listing of Authorized Repair Centers. Contact the Authorized Repair Center of your choice for evaluation of your firearm and/or additional shipping instructions.
2. If your Remington Authorized Repair Center cannot provide the service or repair you require and you need further assistance, please call our toll free number 1-800-243-9700, Mon.-Fri., 9:00 AM-5:00 PM Eastern time and select the option for repairs. Then, if shipment of your firearm is required, please:
 - Record the serial number of your firearm before sending it to us.
 - Pack your firearm for safety and to prevent further damage in shipping and handling. Preferably, ship in a firearm box.
 - Remove all accessories from the firearm to prevent loss or damage.
 - Enclose a letter with the firearm detailing the model name or number of your firearm and serial number along with a full description of the problem. Be sure to include your full name and address (P.O. Box and Street Address), including zip code, daytime telephone number and e-mail address.
 - Ship your firearm by either United Parcel Service (UPS) or Parcel Post (US Post Office). Remington is not responsible for damage or loss during shipment, so you may elect to purchase insurance from your carrier.

Ship to:

Remington Arms Company, Inc.
Attn: Arms Service Division/Repairs
14 Hoefler Ave.
Ilion, NY 13357

WARNING! DO NOT SEND LIVE OR SPENT SHELLS IN YOUR FIREARM OR IN THE SAME BOX WITH THE FIREARM. THIS IS A VIOLATION OF FEDERAL LAW. IF YOU FEEL YOU MUST SEND SPENT SHELLS, PLEASE SEND THEM IN A SEPARATE PACKAGE AND INCLUDE NAME, ADDRESS (WITH ZIP CODE), TELEPHONE NUMBER, MODEL AND SERIAL NUMBER OF YOUR FIREARM.

MODEL 700™ ML/MLS

In-Line Bolt Action Muzzleloading Rifle

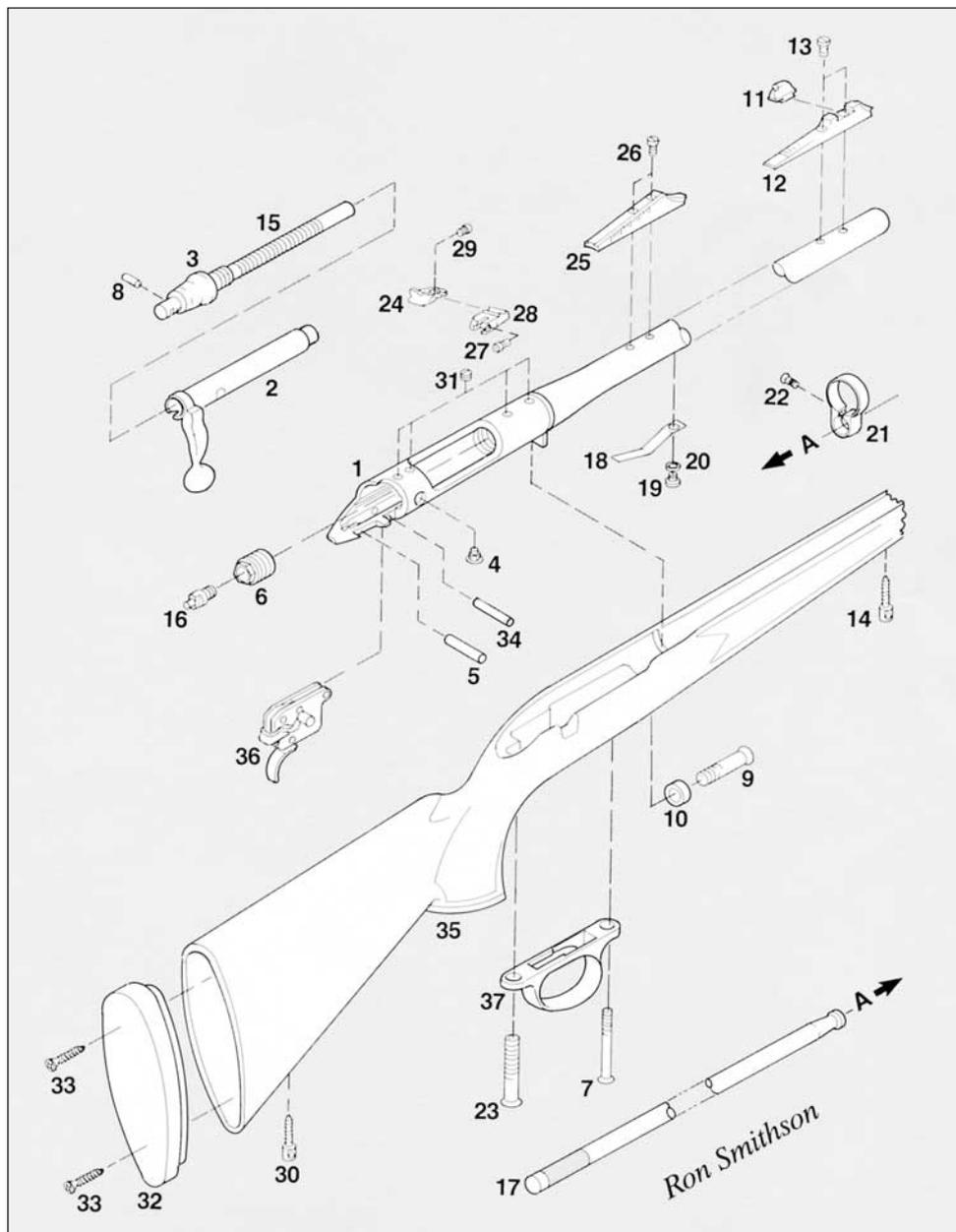

MODEL 700™ ML/MLS

In-Line Bolt Action Muzzleloading Rifle

PARTS LIST

| VIEW # | PART NAME | ACCESSORIES |
|---------------|-------------------------------|---|
| 1 | Barrel Assembly | NOTE: Parts listed below are accessories packed in the box with your Model 700™ ML/MLS. |
| 2 | Bolt Assembly | |
| 3 | Bolt Plug | |
| 4 | Bolt Stop/Cam Follower Screw | |
| 5 | Bolt Stop Pin (Restricted) | |
| 6 | Breech Plug | |
| 7 | Center Guard Screw | |
| 8 | Firing Pin Cross Pin | |
| 9 | Front Guard Screw | |
| 10 | Front Guard Screw Bushing | |
| 11 | Front Sight | Breech Plug/Nipple Wrench |
| 12 | Front Sight Ramp | Cleaning Jag |
| 13 | Front Sight Ramp Screw | Cleaning Rod Receiver Tube |
| 14 | Front Swivel Screw | Hex Key |
| 15 | Mainspring | Ramrod Extension |
| 16 | Nipple | Ramrod Extension Handle |
| 17 | Ramrod | T-Bar |
| 18 | Ramrod Spring | Weather Shroud |
| 19 | Ramrod Spring Screw | |
| 20 | Ramrod Spring Screw Washer | |
| 21 | Ramrod Support | |
| 22 | Ramrod Support Screw | |
| 23 | Rear Guard Screw | |
| 24 | Rear Sight Aperture | |
| 25 | Rear Sight Base | |
| 26 | Rear Sight Base Screw (2) | |
| 27 | Rear Sight Elevation Screw | |
| 28 | Rear Sight Slide | |
| 29 | Rear Sight Windage Screw | |
| 30 | Rear Swivel Screw | |
| 31 | Receiver Plug Screw | |
| 32 | Recoil Pad | |
| 33 | Recoil Pad Screw | |
| 34 | Sear Pin | |
| 35 | Stock Assembly | |
| 36 | Trigger Assembly (Restricted) | |
| 37 | Trigger Guard | |

Firearm Owner's Record

Model _____ Serial # _____ Date Purchased _____

Purchased From _____ Price Paid _____

Remember to complete and return the Firearm Warranty Registration Card in order to obtain full benefit of your Limited Two Year Firearm Warranty.

A WORD ON THE MAINTENANCE AND CARE OF YOUR REMINGTON FIREARM

Don't Alter or Modify Your Gun and Have it Serviced Regularly.

Your firearm has been designed to operate according to certain factory specifications. You'll jeopardize your safety and that of others around you by attempting to alter its trigger, mechanical safety or other mechanisms. So never alter or modify your firearm in any way.

Like any mechanical device, a firearm is subject to wear. It must be maintained and periodically serviced to assure optimum safety and performance. Only a qualified service facility should service, repair or modify your Remington® firearm. Consult your instruction book for instructions on how to send your firearm to the factory or for the location of the nearest Remington repair station. Remington recommends that you have your firearm professionally serviced annually. You should also have your firearm professionally serviced after prolonged storage, or if there is ever any question pertaining to the proper functioning characteristics of your firearm.

Proper cleaning and lubrication are also important to firearm maintenance and are necessary to assure accuracy, safety and reliability. Before cleaning, always make sure that your gun is completely unloaded. And always clean the barrel from the chamber end to the muzzle when possible.

Remington®

REMINGTON IS A TRADEMARK REGISTERED IN THE UNITED STATES PATENT AND TRADEMARK OFFICE BY REMINGTON ARMS COMPANY, INC.