

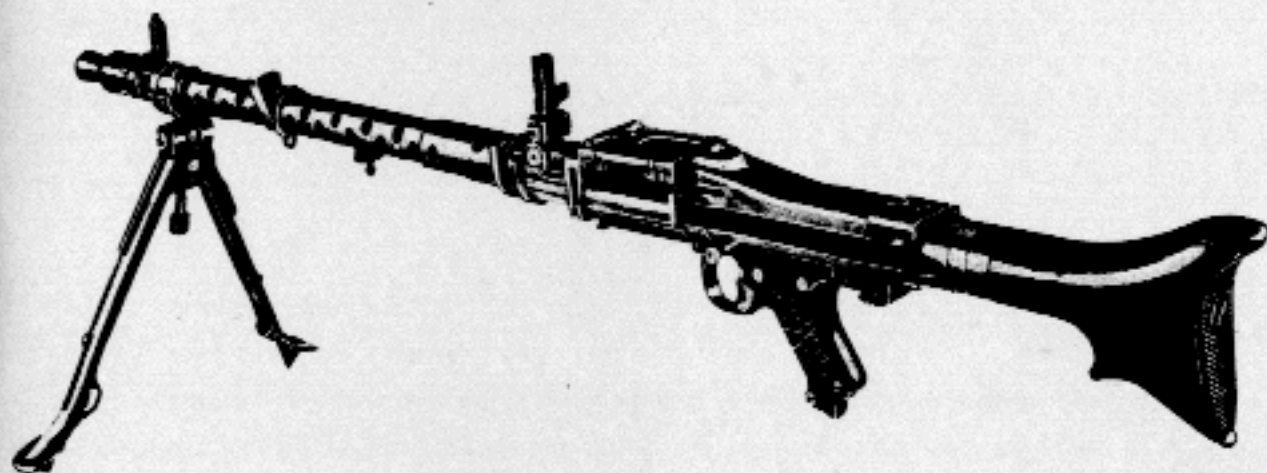
# TM E9-206A

**WAR DEPARTMENT TECHNICAL MANUAL**

*TM E9-206A (German)*

---

German 7.9-mm Dual Purpose  
Machine Gun MG34



---

WAR DEPARTMENT, 13 APRIL 1943

WAR DEPARTMENT  
 Washington 25, D. C., 13 April 1943

TM E9-206A, German 7.9-mm Dual Purpose Machine Gun MG34, is published for the information and guidance of all concerned.

[ A.G. 300.7 (10 Aug 1943)  
 O.O. 461/38198 O.O. (4 Nov 1943) ]

BY ORDER OF THE SECRETARY OF WAR:

G. C. MARSHALL,  
*Chief of Staff.*

OFFICIAL:  
 J. A. ULIO,  
*Major General,  
 The Adjutant General.*

DISTRIBUTION: X

(For explanation of symbols, see FM 21-6.)

A reprint of the original

# CONTENTS

	Paragraphs	Pages
SECTION I. Introduction .....	1-4	4-10
II. Operation .....	5-11	10-36
III. Sighting equipment .....	12	37-40
IV. Malfunctions and corrections....	13-15	40-42
V. Disassembly and assembly.....	16-18	43-48
VI. Care and preservation.....	19-25	49-52
VII. Ammunition .....	26-34	52-63
VIII. Inspection .....	35-40	63-65
IX. Maintenance under unusual con- ditions .....	41-43	65-66
X. Glossary .....	44-45	66-70
XI. References .....	46-47	70

**GERMAN 7.9-MM DUAL PURPOSE MACHINE GUN MG34**

**Section I**

**INTRODUCTION**

	Paragraph
Scope .....	1
Characteristics .....	2
Data .....	3
Cautions .....	4

**1. SCOPE.**

a. This manual is published for the information and guidance of the using arms and services. It contains information required by the using arms to identify, operate, disassemble, assemble, and preserve the German 7.9-mm Dual Purpose Machine Gun MG34.

**2. CHARACTERISTICS.**

a. The German 7.9-mm Dual Purpose Machine Gun MG34 is a recoil-operated, air-cooled weapon capable of delivering single or full automatic fire. The gun is normally fed from 50-round flexible, metal belts, two or more of which can be joined end to end. However, in operations where rapid movement is required, or for antiaircraft fire, a 50-round belt drum magazine or a 75-round spring-operated drum magazine is used. The gun can be identified easily by the recoil booster (fig. 1), perforated barrel casing (fig. 1), grooves for mounting the weapon (fig. 1), front and rear sights (fig. 1), seat for the anti-aircraft sight (fig. 2), hand grip with trigger and safety, dust cover (fig. 2), and fin-shaped butt (fig. 2). It can be used on a bipod (fig. 3), on an antiaircraft tripod (fig. 4), or on a tripod mount (fig. 5).

**3. DATA.**

Weight of machine gun, with bipod .....	26¾ lb
Weight of machine gun, without bipod .....	24¼ lb
Weight of barrel .....	4.44 lb
Over-all length .....	48¼ in.
Length of barrel .....	24½ in.
Caliber .....	(7.9 mm) 0.312 in.
Sight radius .....	20 <sup>15</sup> / <sub>16</sub> in.
Rifling .....	4 right-hand concentric grooves
Cyclic rate of fire .....	800 to 900 rounds per min

**4. CAUTIONS.**

a. All preservative and dirt must be removed from the gun before firing. To do this, disassemble the gun (par. 17) and clean as instructed in paragraph 22.

**INTRODUCTION**

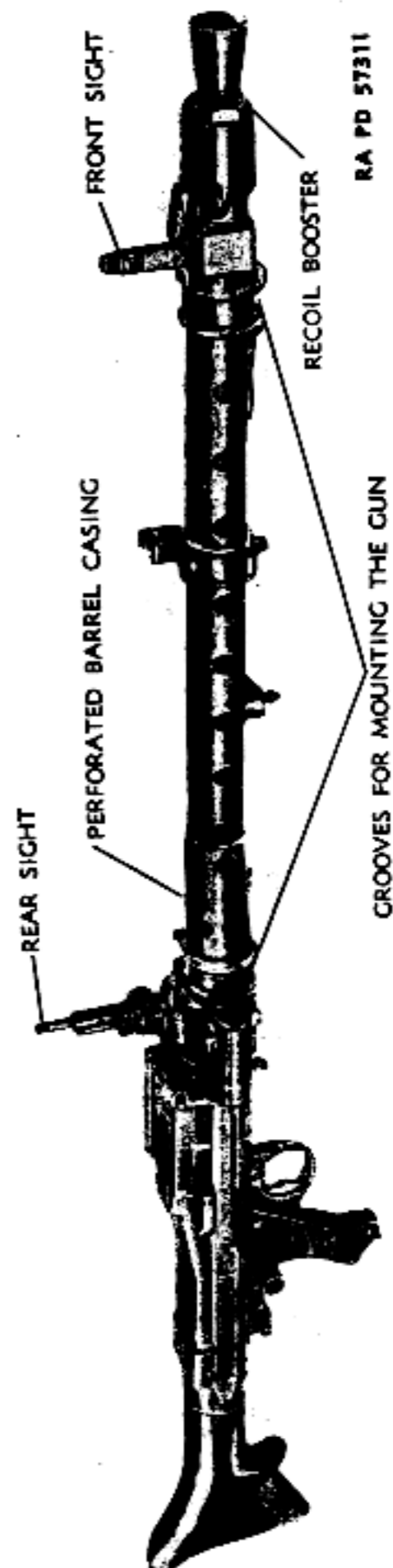
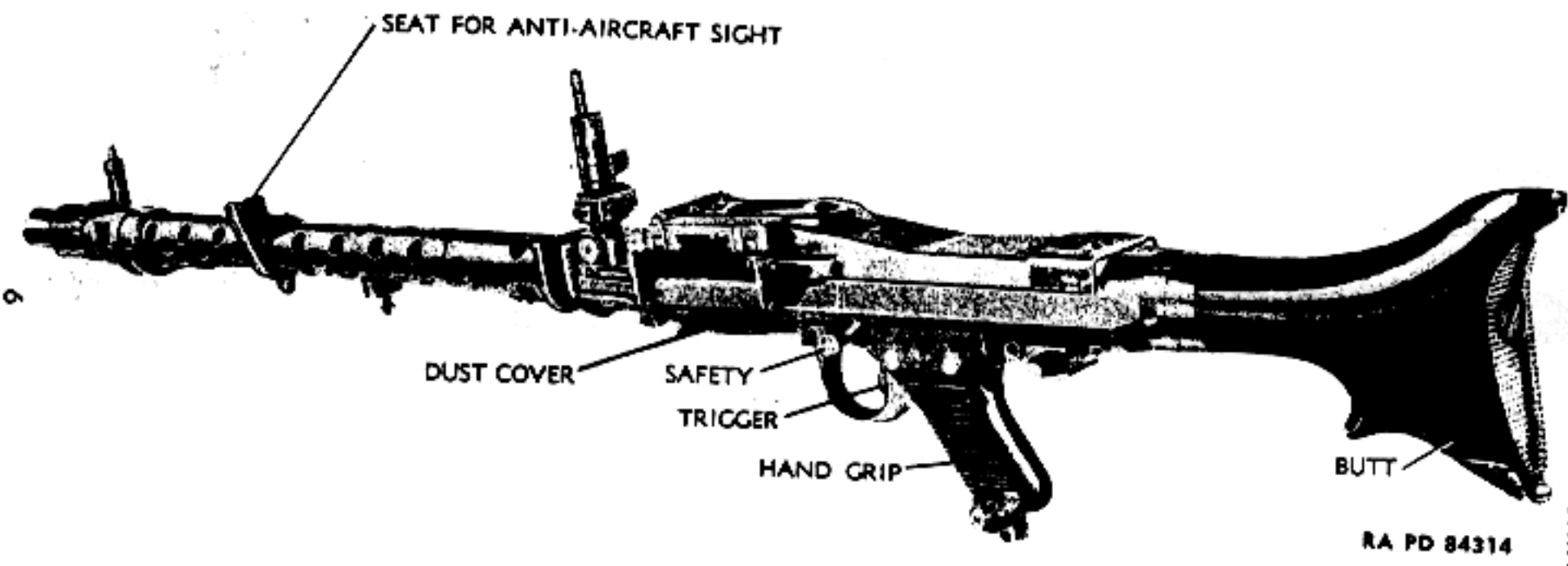


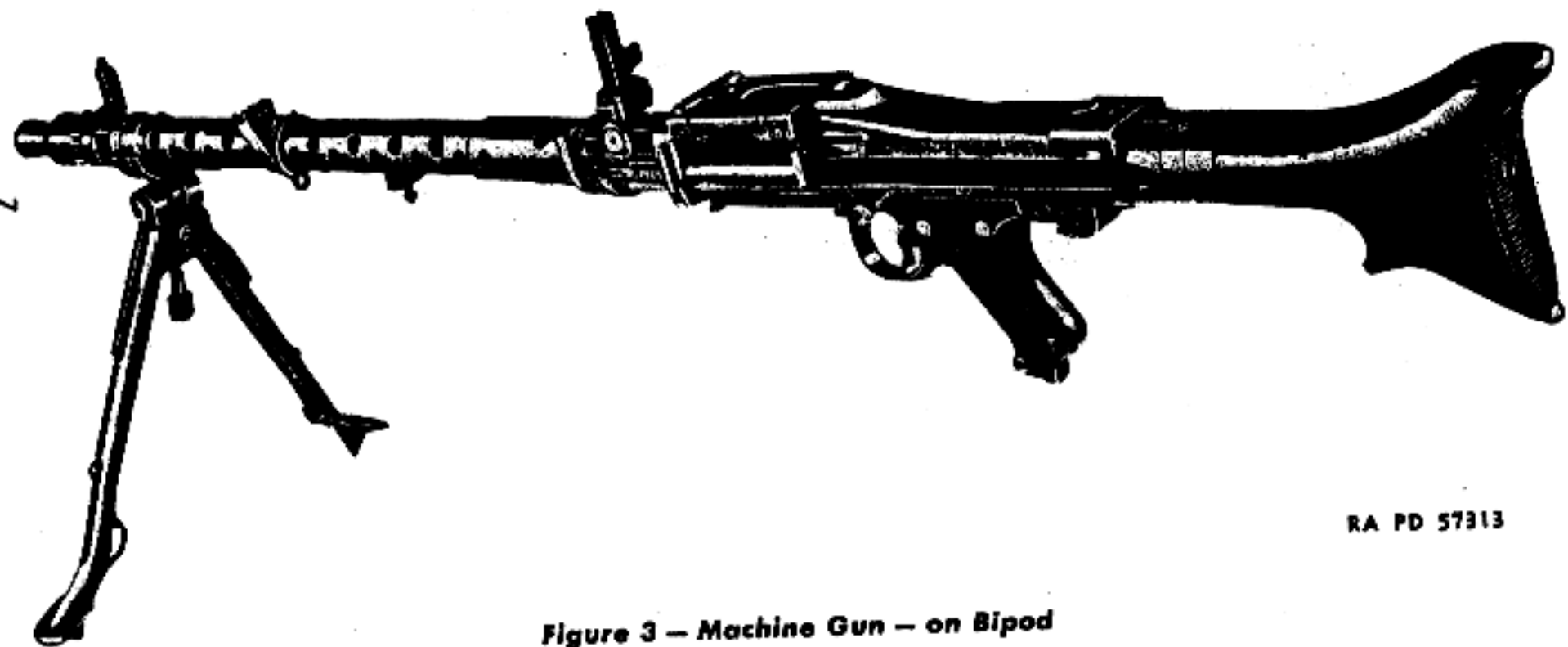
Figure 1 — German 7.9-mm Dual Purpose Machine Gun MG34 — Right Side View

GERMAN 7.9-MM DUAL PURPOSE MACHINE GUN MG34



RA PD 84314

Figure 2 - German 7.9-mm Dual Purpose Machine Gun MG34 - Left Side View



INTRODUCTION

RA PD 57313

Figure 3 - Machine Gun - on Bipod

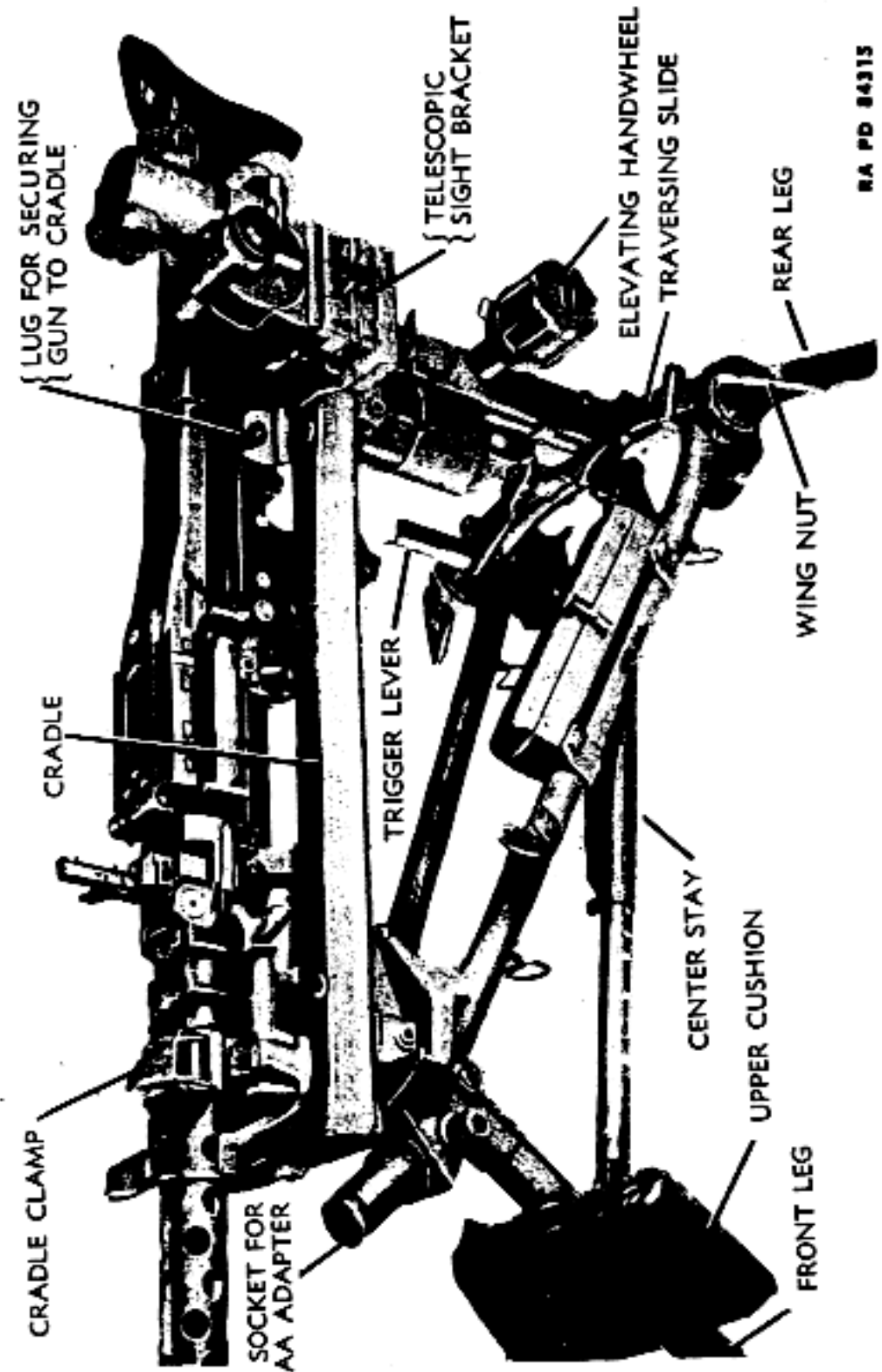
GERMAN 7.9-MM DUAL PURPOSE MACHINE GUN MG34



RA PD 57314

Figure 4 - Machine Gun - on Antiaircraft Tripod

INTRODUCTION



RA PD 84315

Figure 5 - Machine Gun - on Tripod Mount

**GERMAN 7.9-MM DUAL PURPOSE MACHINE GUN MG34**

b. Do not attempt to fire this gun with ammunition issued only for United States weapons, as it will damage the gun and injure the operator. Use only enemy ammunition or other ammunition specifically authorized by ordnance personnel (par. 31).

c. Before using any ammunition, make certain the ammunition and belt are clean and free of all traces of sand and dust.

d. The mechanism of the gun is very sensitive to dust or sand. When the gun is not in action, keep the dust cover (fig. 2) on the ejection opening closed.

e. It is dangerous to investigate a feed stoppage or malfunction by raising the feed cover without first cocking the gun or retaining a hold on the cocking handle. Should a live round remain in the chamber, the raising of the feed cover would allow the bolt to continue forward to fire the round, thus causing damage. Should a stoppage occur during firing, cock the gun and move the safety to **SAFE**. Then push the feed cover catch forward, raise the feed cover, and lift out the belt. If the gun cannot be cocked, apply a backward pull on the cocking handle and, at the same time, raise the feed cover and remove the belt. The gun can then be cocked. For further instructions, see section IV.

f. Unload the gun before transporting the gun from one place to another (par. 10).

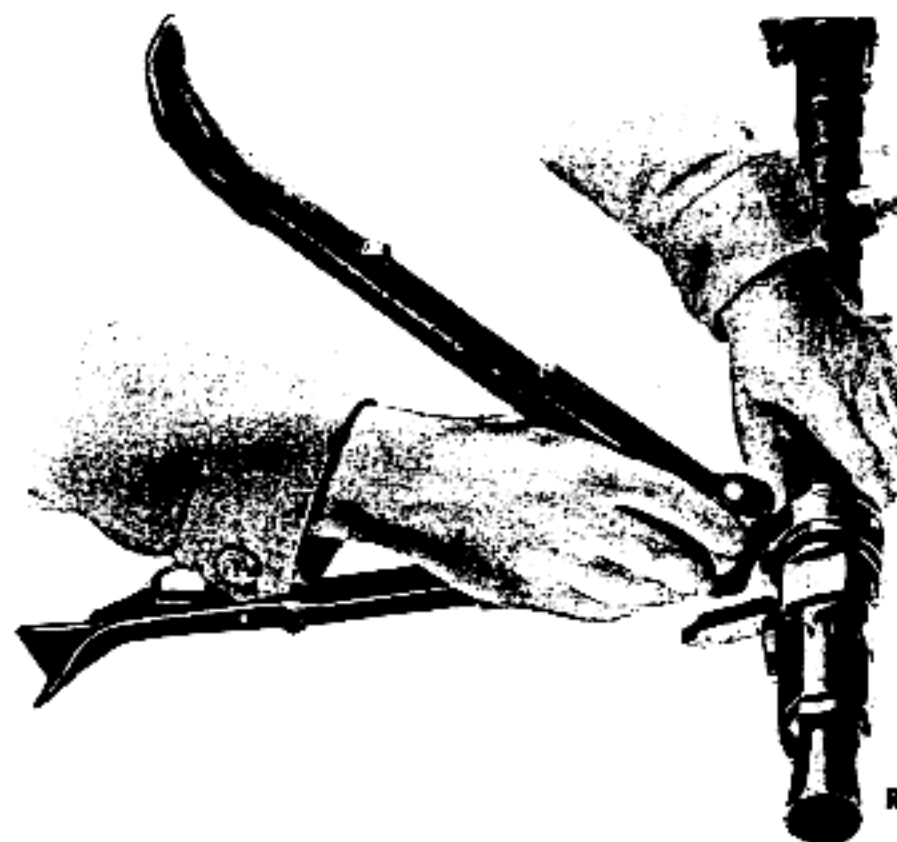
**Section II  
OPERATION**

	Paragraph
Mounting the machine gun.....	5
Dismounting the machine gun.....	6
Filling the belts and magazines.....	7
Loading the machine gun.....	8
Firing the machine gun.....	9
Unloading the machine gun.....	10
Changing barrels.....	11

**5. MOUNTING THE MACHINE GUN.**

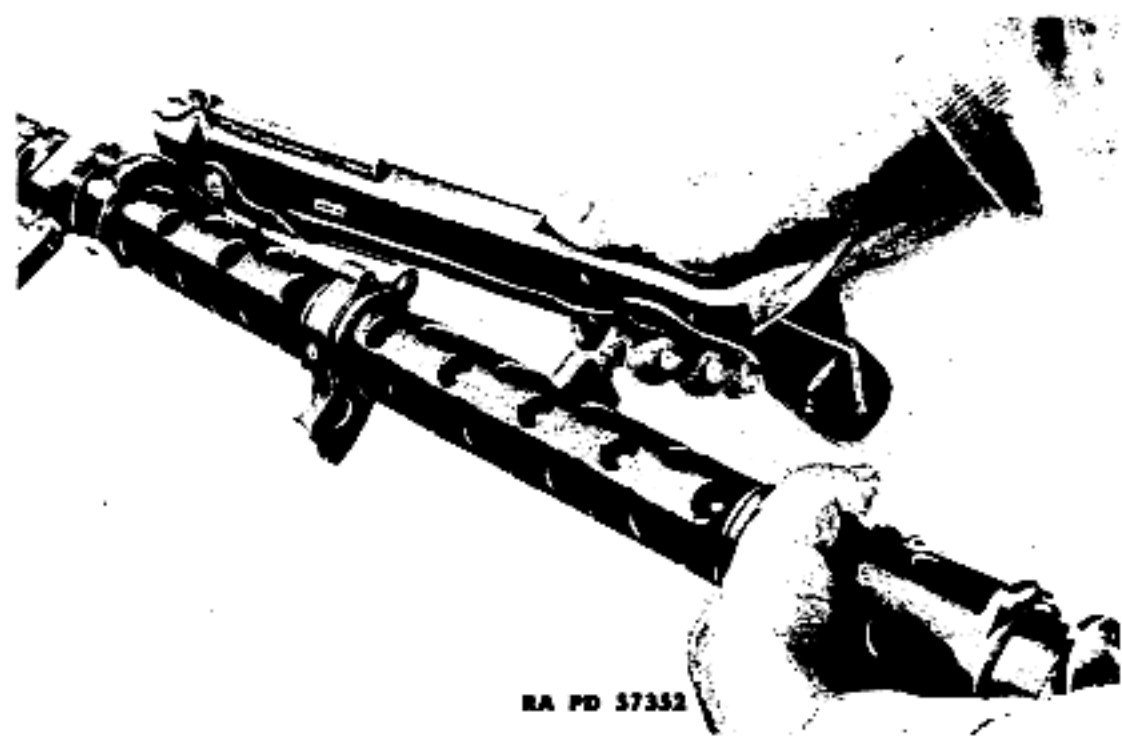
a. On the Bipod. Slide the curved head of the bipod into the front mounting guide on the barrel casing. Depress the bipod catch spring on the underside of the casing (fig. 6), and rotate the bipod in the guide until the spring snaps into position. Turn the bipod legs toward the muzzle end and set them on the ground. To adjust the

**OPERATION**



RA PD 57321

**Figure 6 - Mounting Machine Gun on Bipod**



RA PD 57352

**Figure 7 - Attaching Bipod Legs to Barrel Casing**

spread of the bipod legs, rotate the thumbscrew at the junction of the legs.

**NOTE:** If the gun is to be carried, collapse the bipod legs, fold

### GERMAN 7.9-MM DUAL PURPOSE MACHINE GUN MG34

them backward against the barrel casing, and secure them to the knob on the casing (fig. 7).

**h. On the Antiaircraft Tripod.** Place the machine gun on the tripod so that the curved head on the tripod slides into the rear mounting guide on the barrel casing. Depress the tripod catch spring, and rotate the machine gun until the spring snaps into position (fig. 8). The tripod legs are both hinged and telescopic, to permit large adjustments in the height of the firing position. Smaller adjustments can be made by means of the adjustable support at the top of the tripod.

#### **c. On the Tripod Mount.**

(1) If the tripod mount is folded, it should be unfolded and erected as follows:

(a) Release the clamping lever on the front leg, extend the front leg to the required position, and then lock the clamping lever.

(b) Loosen the wing nuts on the rear legs, and push the rear legs back. Raise the mount the required height and tighten the wing nuts.

(c) With one hand, grasp the handle; with the other hand, grasp the cradle. Push the press lever forward and raise the cradle, drawing the elevating gear smartly back (fig. 9) until it stands erect and engages the upper part of the mount.

(d) Adjust the legs, so that the cradle is horizontal when the elevating gear is adjusted to its old position. The machine gun can now be mounted on the mount.

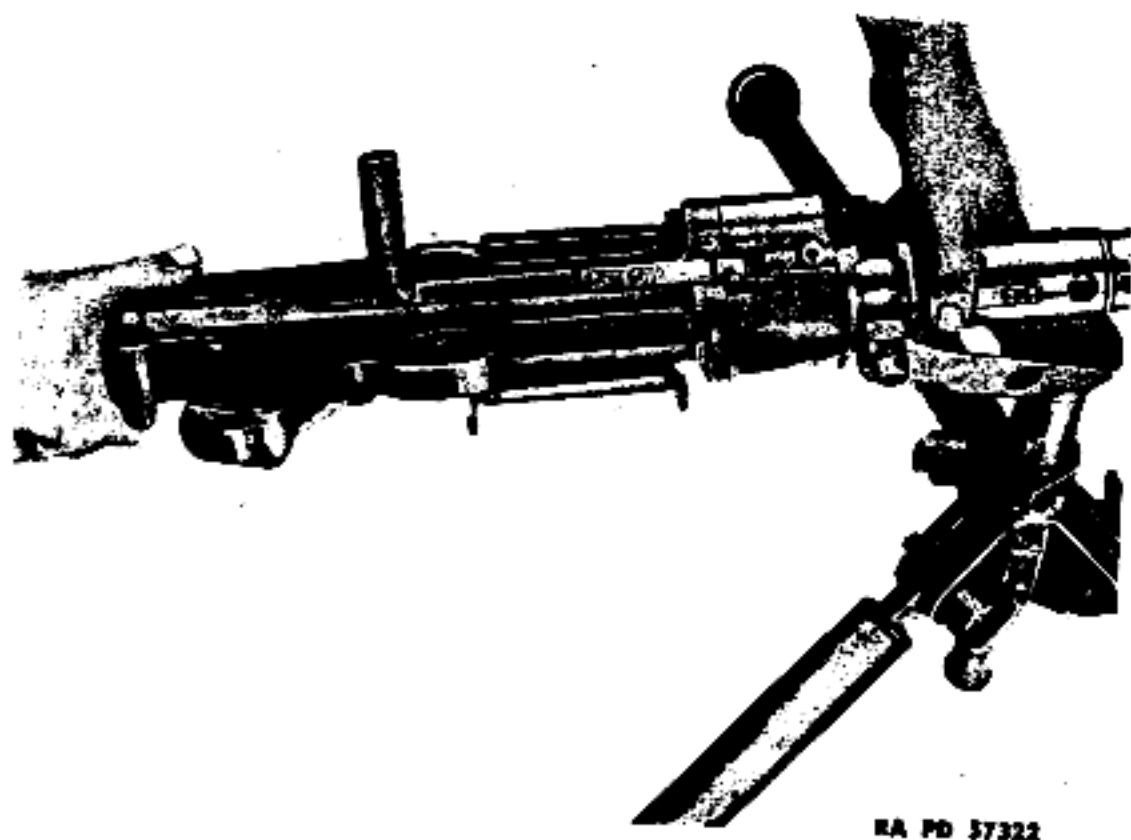


Figure 8 — Mounting Machine Gun on Antiaircraft Tripod

### OPERATION

(2) Place the machine gun (muzzle end up) on the mount, so that the projections on each side of the gun fit into the claws on the cradle (fig. 10). Lower the front part of the gun on the cradle and secure it by means of the hinge clamp.

**d. On Antiaircraft Adapter of Tripod Mount.** For antiaircraft fire from the tripod mount, an adapter is secured in the short tube near the swivel (fig. 5). The adapter is similar to the adjustable support at the top of the tripod. The gun is mounted on the adapter as on the tripod. The cradle must be folded when the adapter is used and the adapter should be in a vertical position.

### 6. DISMOUNTING THE MACHINE GUN.

**a.** To dismount the machine gun, proceed in the reverse order of mounting (par. 5).

### 7. FILLING THE BELTS AND MAGAZINES.

#### **a. Belts.**

(1) Place a 50-round leading belt on a flat surface, with the leading tab to the right and the tongues up. Insert a round into each link, and push it forward until the tongue snaps into the groove at the rear of the cartridge case (fig. 11).

**NOTE:** Do not insert a round into the first link. This link is short and has no tongue (fig. 11).

(2) The 50-round leading belt can be extended by joining it to 50-round extension belts. Fill a 50-round extension belt, but do not fill the first link having the rectangular opening (fig. 11). Insert the tongue at the end of the leading belt into the rectangular opening in the first link of the extension belt, and join belts by inserting a round (fig. 11). It is common practice to join as many as four extension belts to a 50-round leading belt.

(3) Instead of a 50-round leading belt, it is possible to join five 50-round extension belts to a short leading belt (fig. 12).

(4) If a short leading belt is not available, an extension belt (or belts) can still be used. However, when loading the belt, do not insert rounds in first three links.

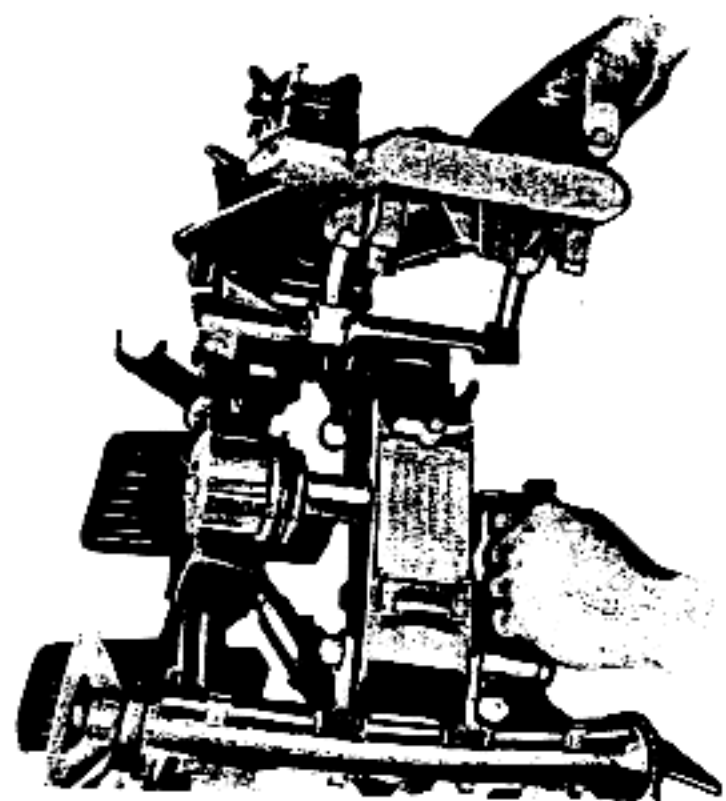
#### **b. 50-round Belt Drum Magazine.**

(1) Fill an extension belt and turn it over with tongues on bottom and empty link to the right. Roll up the belt from the left end and insert it into the belt drum magazine with the empty link on the outside (⊙ fig. 13).

(2) If the magazine is to be used immediately or within a short time, fill a short leading belt and attach it (⊙ fig. 13). If the magazine is not to be used for some time, do not join a short leading belt. Instead, close the magazine slide and the cover, to keep dust out.

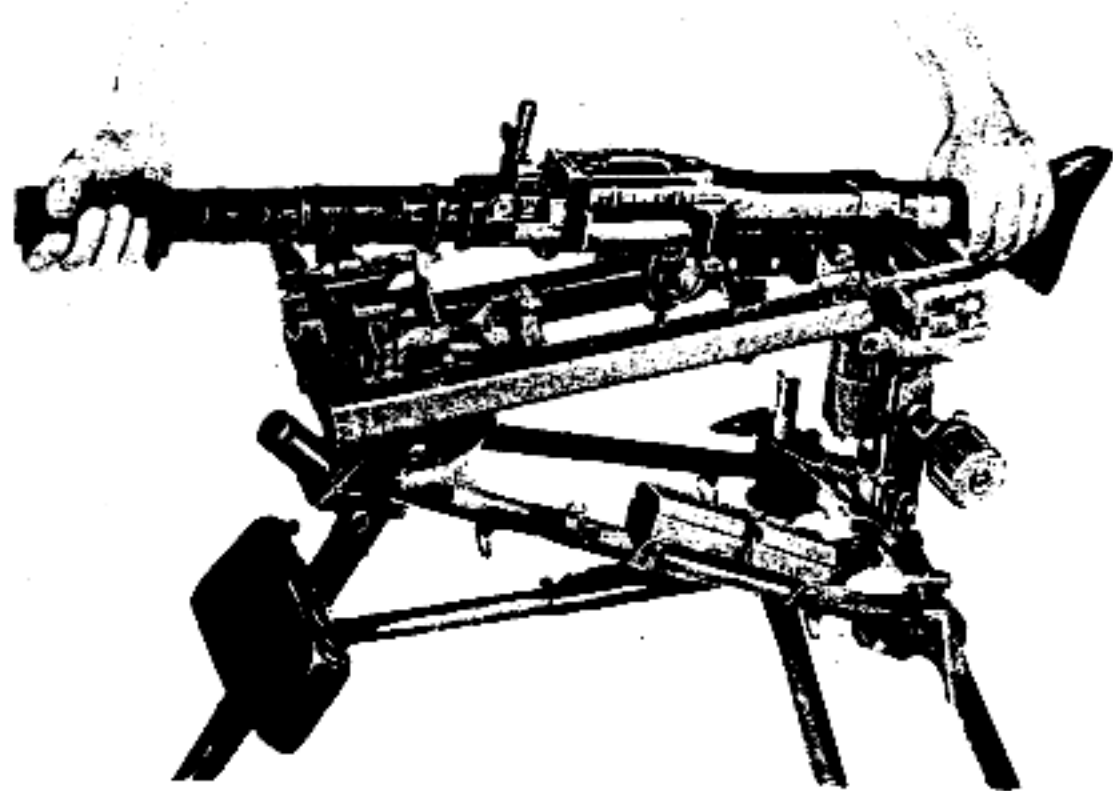
(3) The magazines are transported in carriers shown in figure 14.

## GERMAN 7.9-MM DUAL PURPOSE MACHINE GUN MG34



RA PD 57324

Figure 9 — Raising Cradle of Tripod Mount



RA PD 57323

Figure 10 — Mounting the Machine Gun on the Tripod Mount

## OPERATION

c. Spring-operated 75-round Drum Magazine. Apply tension to the magazine springs by turning the two tensioning ratchets on the magazine (fig. 27). Use an enemy tool (if available) or an improvised tool. Then, place the magazine with the mouth up and insert one round after another (fig. 15) until the magazine is filled.

## 8. LOADING THE MACHINE GUN.

a. General. Belt feed can be employed when the gun is mounted on the bipod, antiaircraft tripod, tripod mount, or tripod mount attachment. The 50-round belt drum magazine, and the 75-round spring-operated drum magazine, can be employed when the gun is mounted on the bipod, antiaircraft tripod, or tripod mount attachment, but not on the tripod mount.

## b. Loading the Machine Gun With the Belt.

(1) If the bolt is fully home (in most forward position), press the safety lever (fig. 16), and move the safety forward to uncover the letter "F" (fig. 17). If the bolt is retracted, grasp the cocking handle, and, at the same time, pull the trigger, allowing the bolt to go slowly home. Set the safety at FIRE (move it forward to uncover letter "F").

(2) Push the feed cover catch forward and open the feed cover (fig. 18).

(3) Place the loaded belt on the feed block, so that the first round is on the slot of the feed block, and the leading tab is to the right (fig. 19).

(Text continued on page 21.)



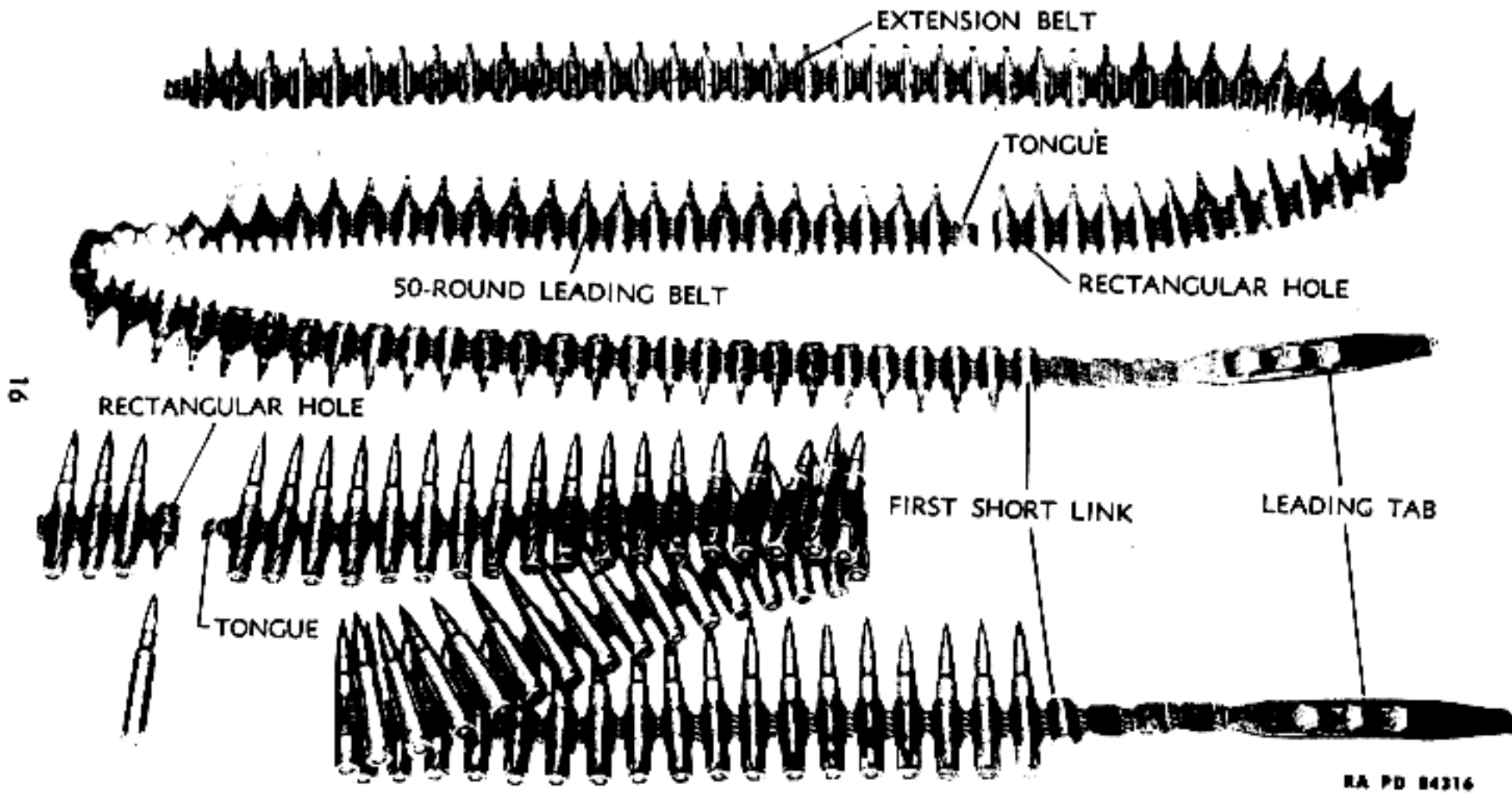


Figure 11 - Loading and Joining of Extension Belt and Leading Belt

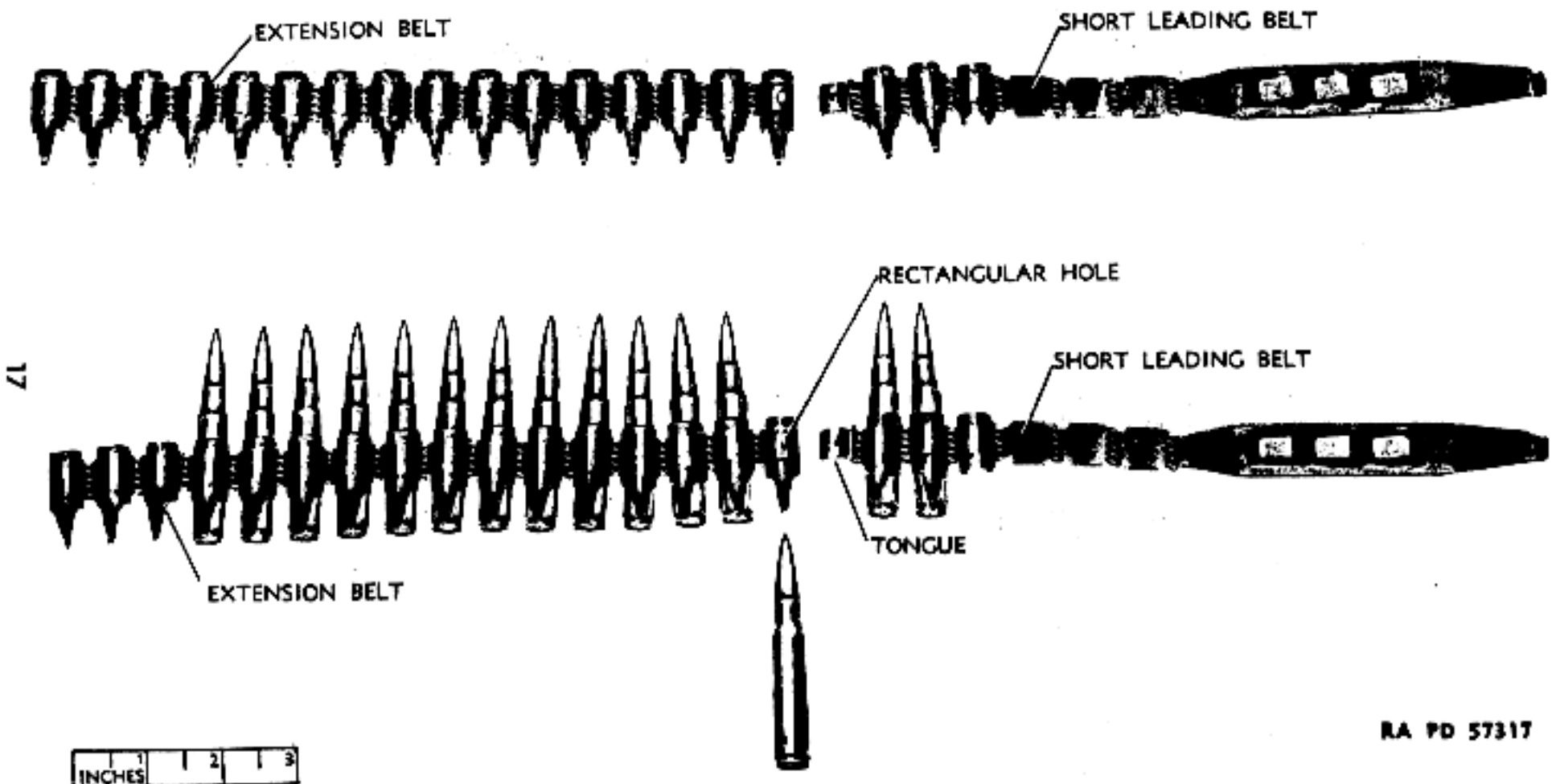
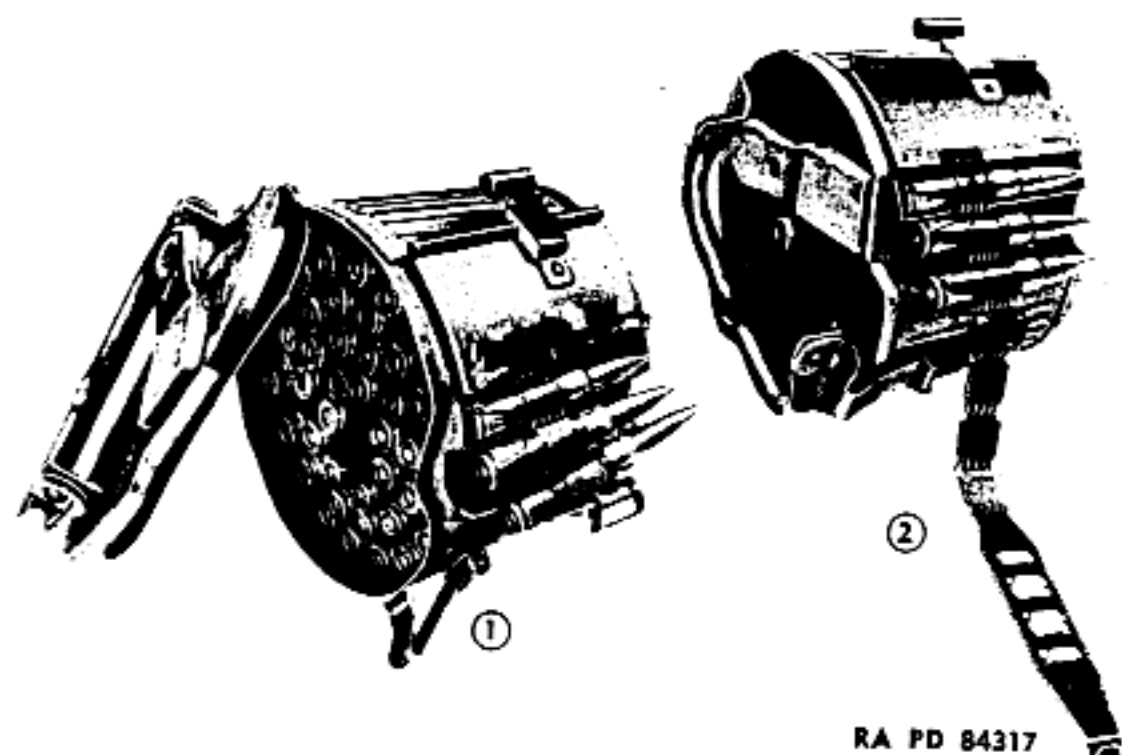


Figure 12 - Loading and Joining of Extension Belt and Short Leading Belt

GERMAN 7.9-MM DUAL PURPOSE MACHINE GUN MG34



RA PD 84317

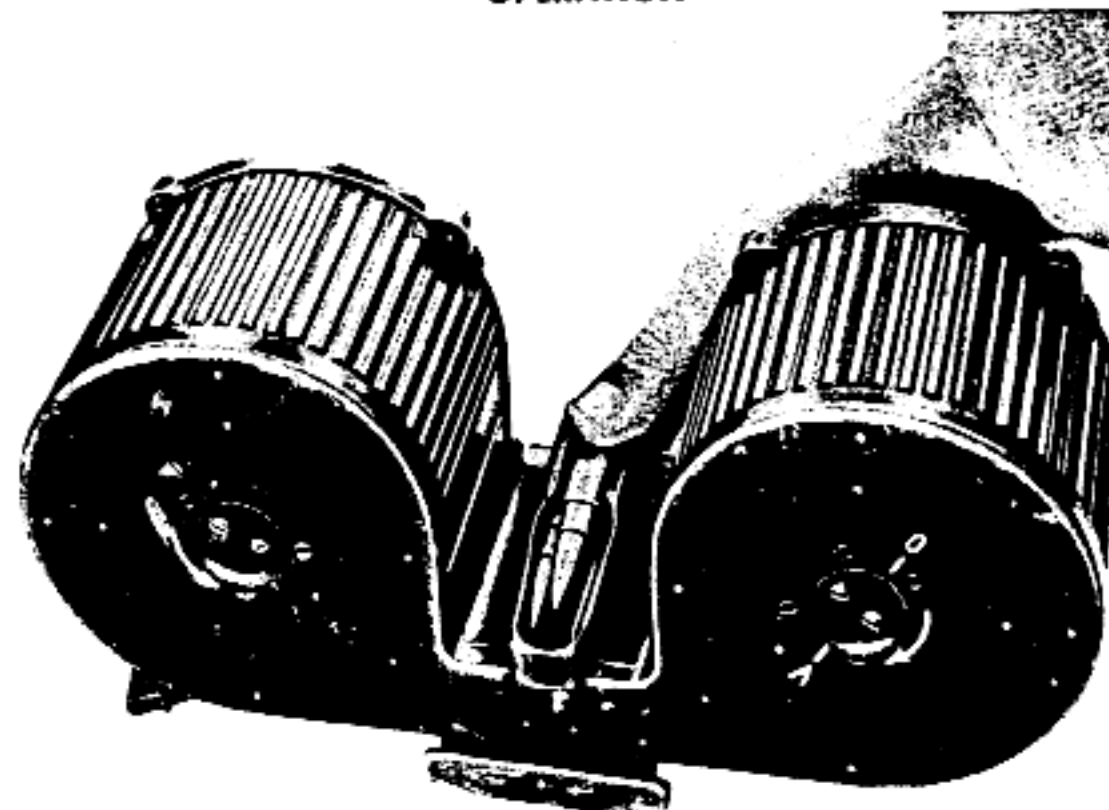
Figure 13 - Loading a Belt Drum Magazine



RA PD 57319

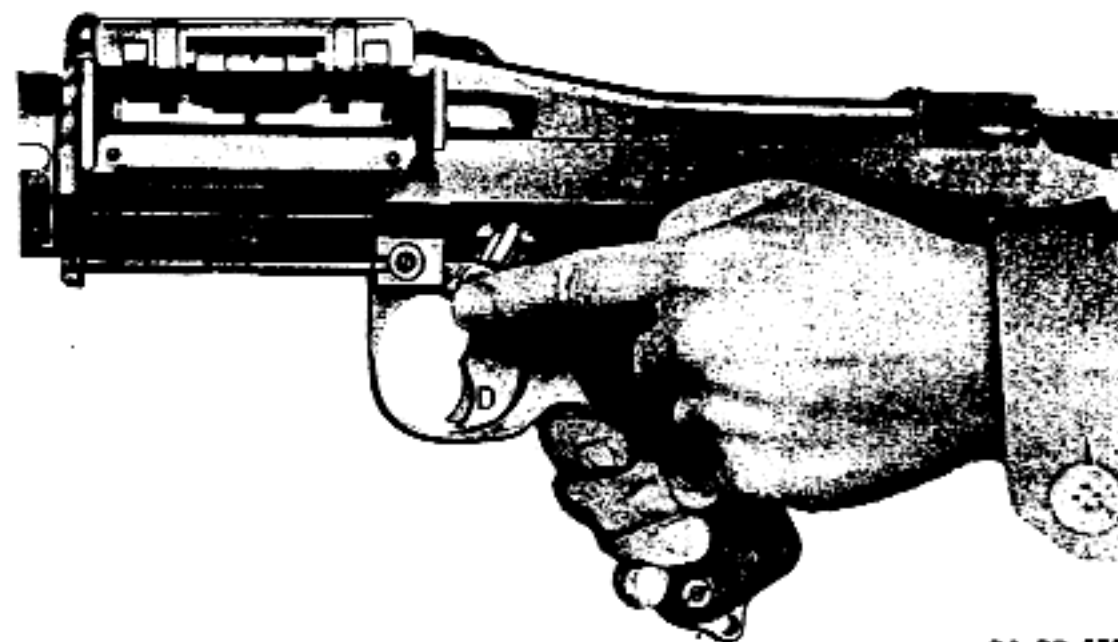
Figure 14 - Belt Drum Magazines in Carriers

OPERATION



RA PD 57320

Figure 15 - Loading 75-round Magazine



RA PD 57341

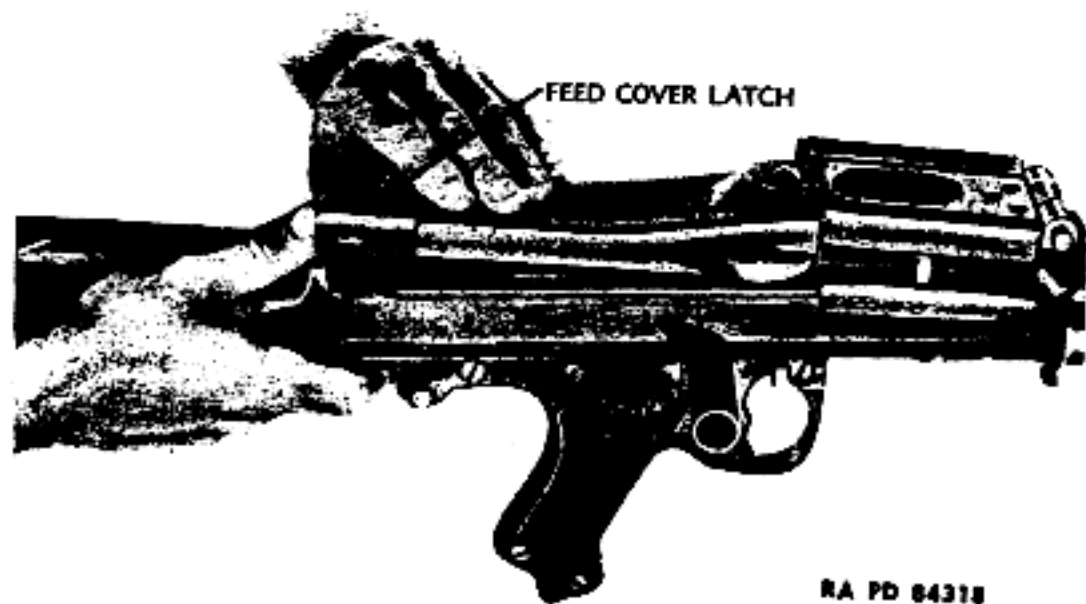
Figure 16 - Adjustment of Safety

GERMAN 7.9-MM DUAL PURPOSE MACHINE GUN MG34



RA PD 57357

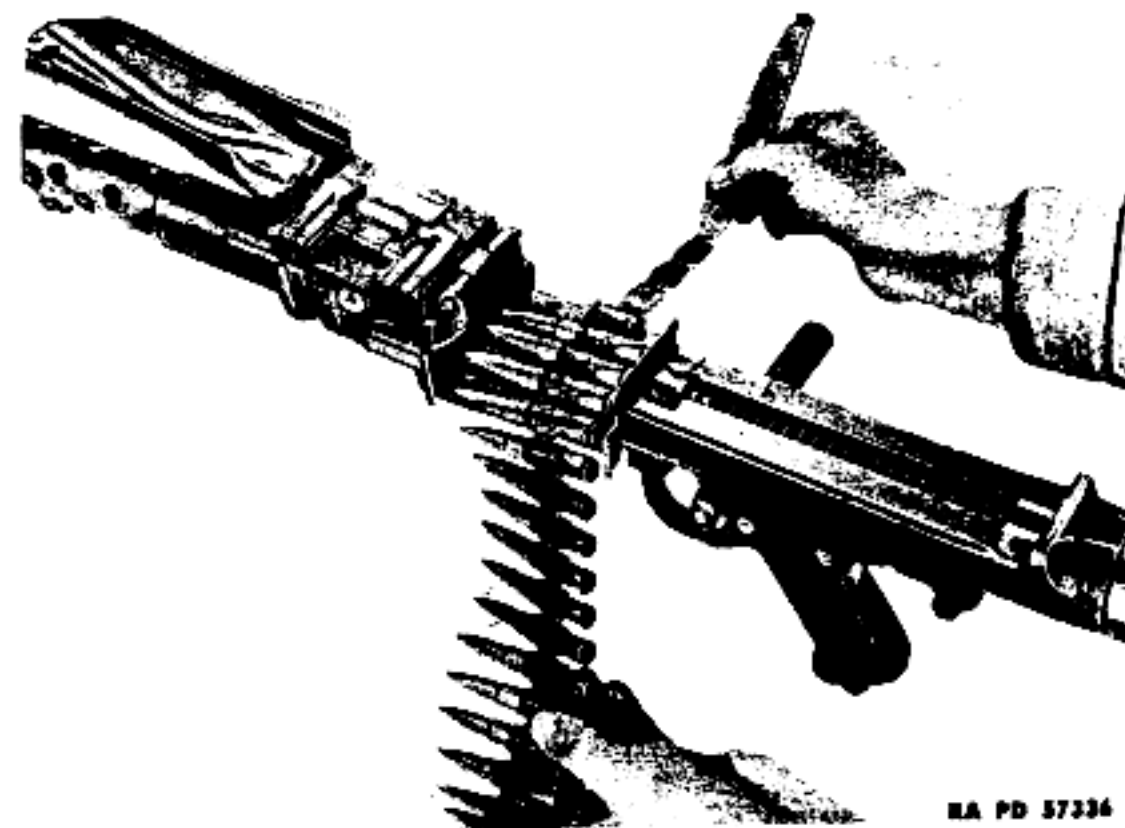
Figure 17 — Safety at Fire — Letter "F," Uncovered



RA PD 84318

Figure 18 — Opening Feed Cover

OPERATION



RA PD 57336

Figure 19 — Positioning Belt on Feed Block

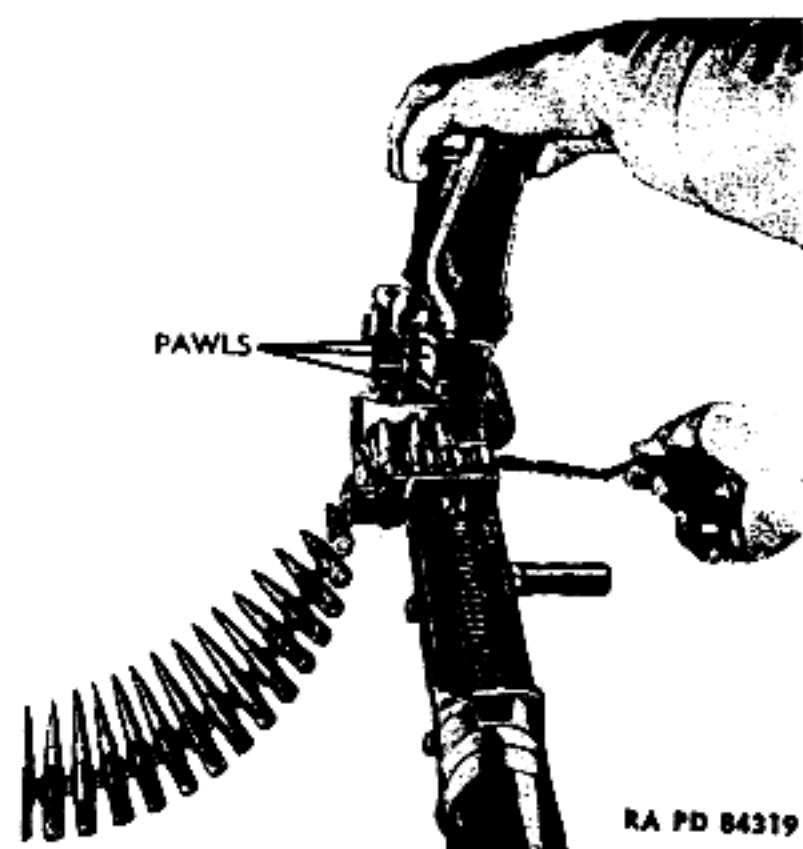
(4) Close the feed cover, making certain that the three pawls on the underside of feed cover engage the first round (fig. 20), that is, the three pawls are between the first and second rounds.

(5) After the operator has become proficient in loading the gun, he may keep the feed cover closed while loading. In that case, make certain the bolt is fully home and the safety at FIRE (letter "F" uncovered). Then, insert the leading tab into the feed opening on the left side of the gun, and pull it to the right until the three pawls on the underside of the feed cover engage the first round (fig. 21).

NOTE: In case of right-hand feed, the leading tab is inserted into the feed opening on the right side of the gun.

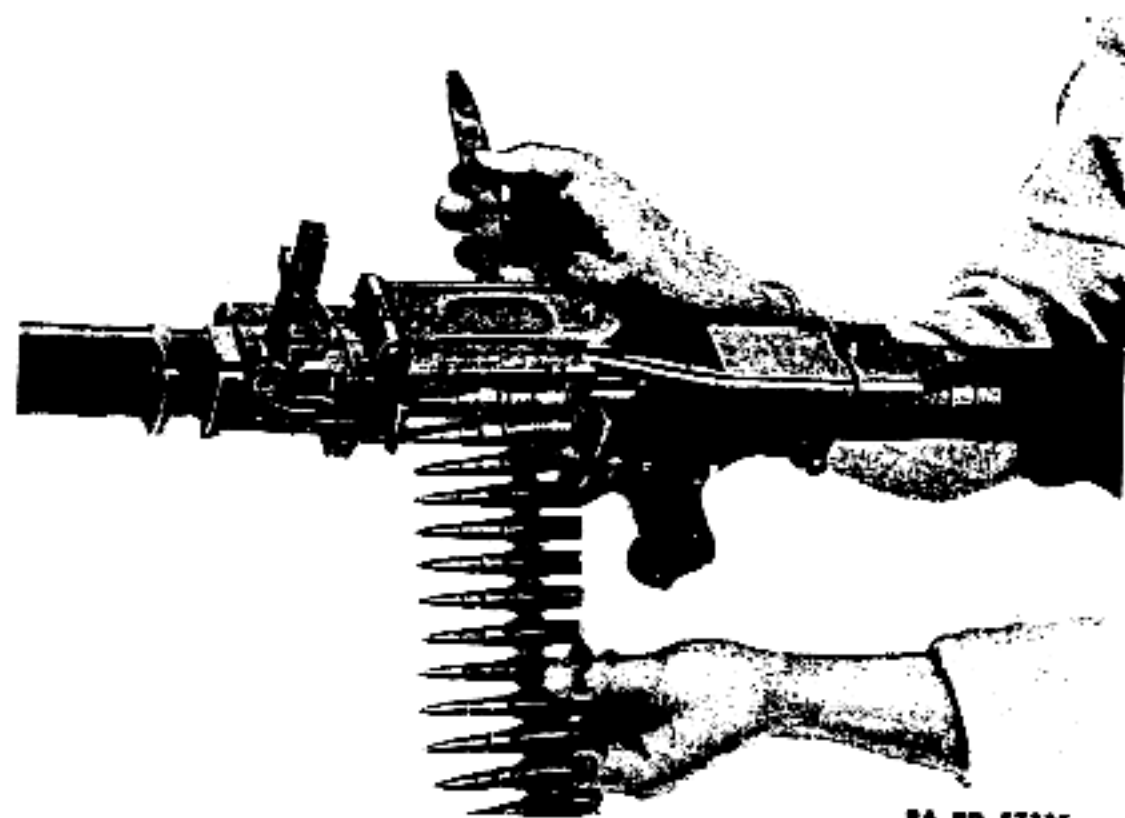
c. Loading the Machine Gun With a 50-round Belt Drum Magazine. See that the bolt is fully home and the safety set at FIRE (move safety forward to uncover letter "F," (fig. 17)). Take a fully loaded belt drum magazine (⊙ fig. 13) and insert the leading tab into the feed opening on the left side of the gun. Attach the magazine to the front hook on the feed block (fig. 22), press the latch on the magazine, and secure it to the rear hook on the feed block. Pull the

## GERMAN 7.9-MM DUAL PURPOSE MACHINE GUN MG34



RA PD 84319

Figure 20 - Closing of Feed Cover



RA PD 57335

Figure 21 - Loading Machine Gun with Belt

## OPERATION

leading tab to the right until the three pawls on the underside of the feed cover engage the first round.

**d. Loading the Machine Gun With a 75-round Spring-operated Drum Magazine.**

(1) To load the machine gun with the 75-round magazine, it is necessary to remove the feed cover and feed block, and to replace these with the magazine holder. To facilitate identification, the feed cover and magazine holder are compared in figures 23 and 24.

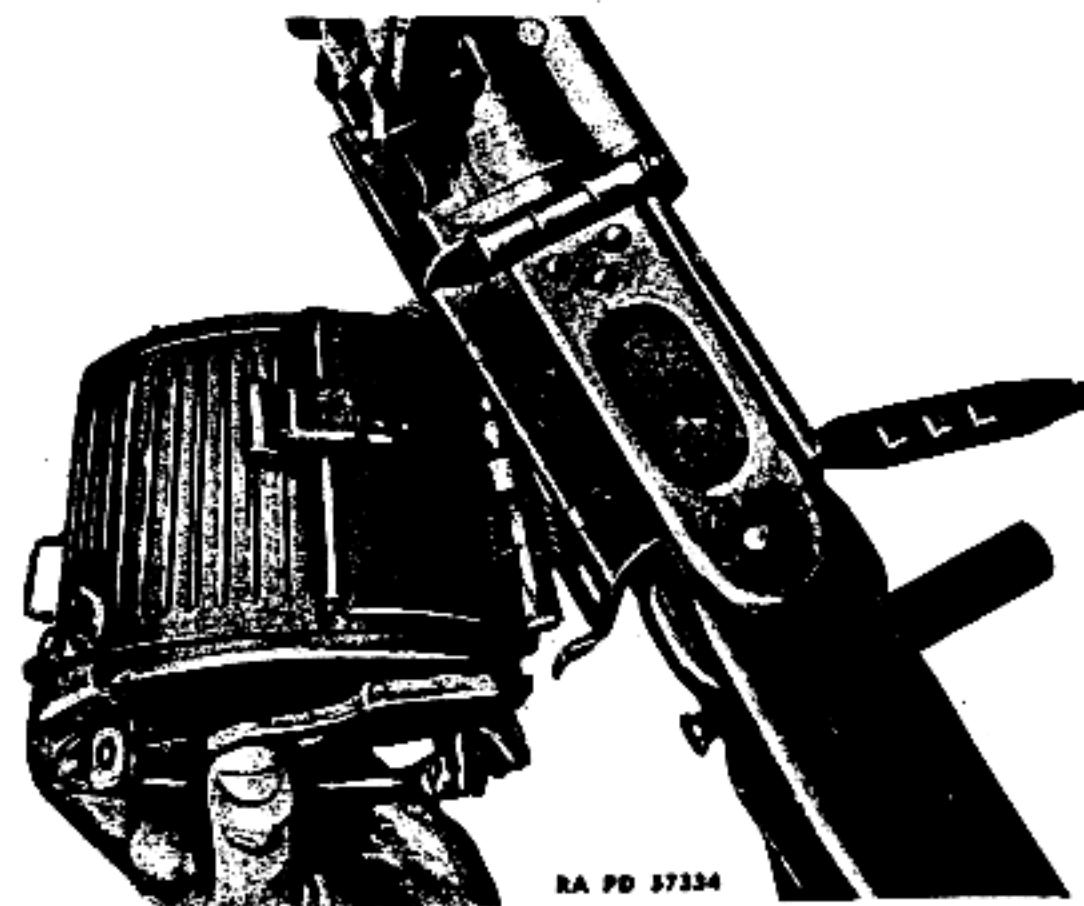
(2) See that the bolt is fully home and the safety set at FIRE (move safety forward to uncover letter "F," (fig. 17)). Push the feed cover catch forward and raise the feed cover (fig. 18). Press the feed cover axis pin to the left and remove the feed cover (fig. 25).

(3) Remove the feed block (fig. 26). Press the feed cover axis pin to the left and replace with the magazine holder.

(4) Place a full 75-round magazine on the magazine holder, front end down, and press it down until the latch on the holder snaps into position (fig. 27).

**9. FIRING THE MACHINE GUN.**

**a. General.** Before carrying out the following instructions, make certain that the machine gun has been loaded with a belt or magazine, and the safety set at FIRE (move safety forward to uncover letter "F," (fig. 17)).



RA PD 57334

Figure 22 - Mounting Belt Drum Magazine

**GERMAN 7.9-MM DUAL PURPOSE MACHINE GUN MG34**

**b. Firing Gun on Bipod, Antiaircraft Tripod, or Tripod Mount Attachment.**

(1) With one hand, grasp the cocking handle in its most forward position (fig. 28) and retract it until the bolt is cocked (fig. 29). Then push the cocking handle forward as far as it will go (fig. 30).

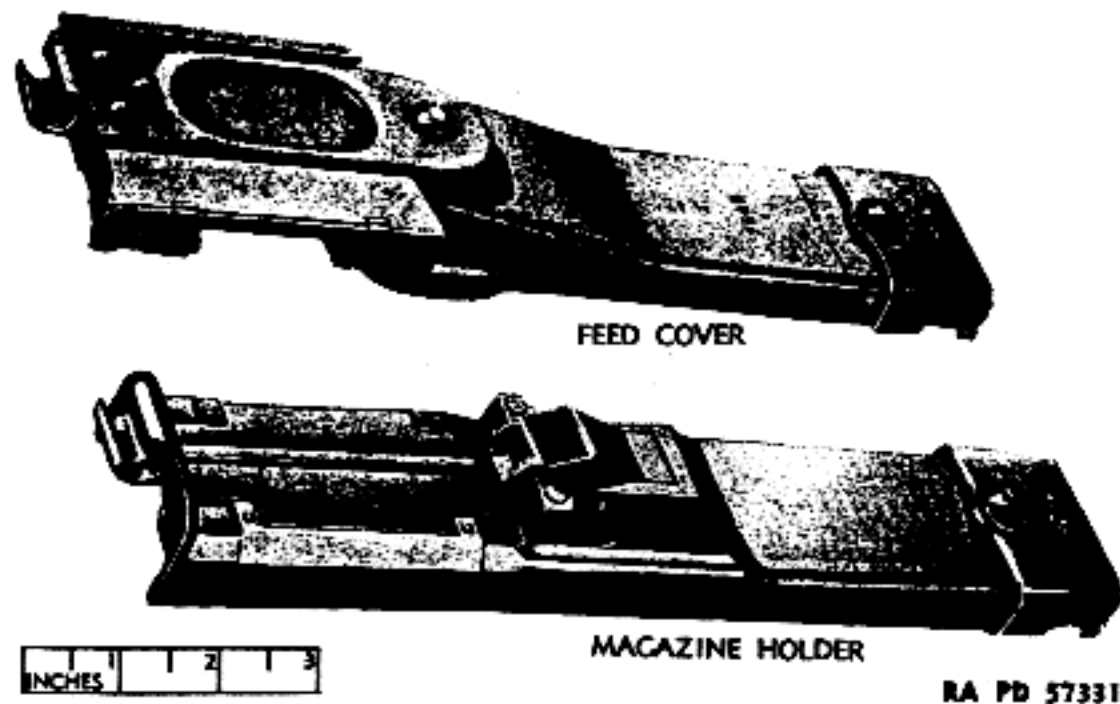
(2) **SINGLE FIRE.** For single fire, pull the upper part of the trigger marked with the letter "E" (fig. 17) and release it immediately. It is necessary to pull the trigger for every shot to be fired. During lulls in firing, the safety should be kept at **SAFE**. This is done by pressing the safety lever (fig. 16) and moving the safety to the rear to uncover the letter "S" (fig. 31).

(3) **AUTOMATIC FIRE.** For automatic fire, pull the lower part of the trigger marked with the letter "D" (fig. 17). The machine gun will deliver automatic fire as long as the trigger is pulled and ammunition is being fed into the gun. Between bursts, set the safety at **SAFE** (move it to the rear to uncover letter "S" (fig. 31)).

**c. Firing the Gun on the Tripod Mount.**

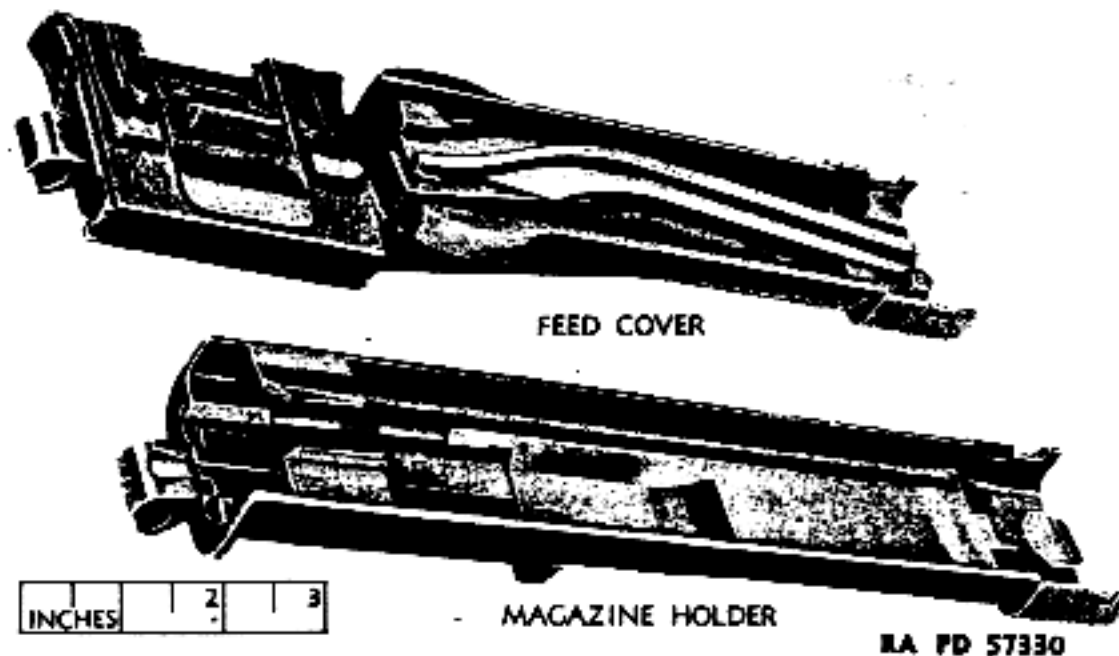
(1) Grasp the cocking handle in its most forward position (fig. 28) and retract it until the bolt is cocked (fig. 29). Then push the cocking handle forward as far as it will go (fig. 30).

(2) **SINGLE FIRE.** For single fire, push up the trigger finger on the mount (fig. 32). Then pull the trigger handle on the mount (fig. 33) and release it. The handle must be pulled for each shot to be fired. During lulls in firing, set the safety at **SAFE** (move it to rear to uncover letter "S" (fig. 31)).

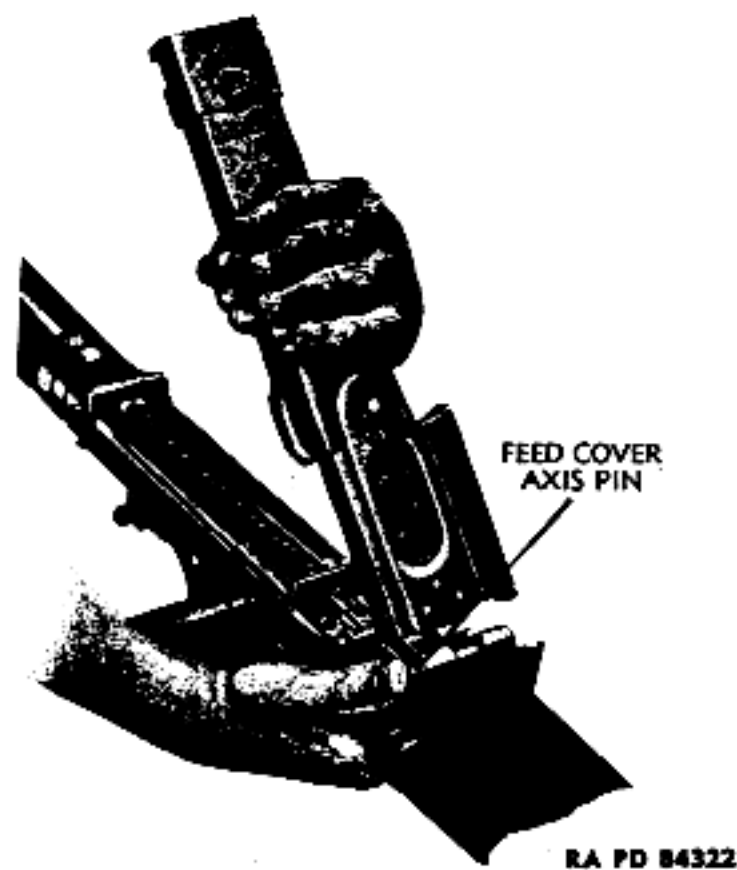


**Figure 23 – Feed Cover and Magazine Holder – Top View**

**OPERATION**



**Figure 24 – Feed Cover and Magazine Holder – Bottom View**



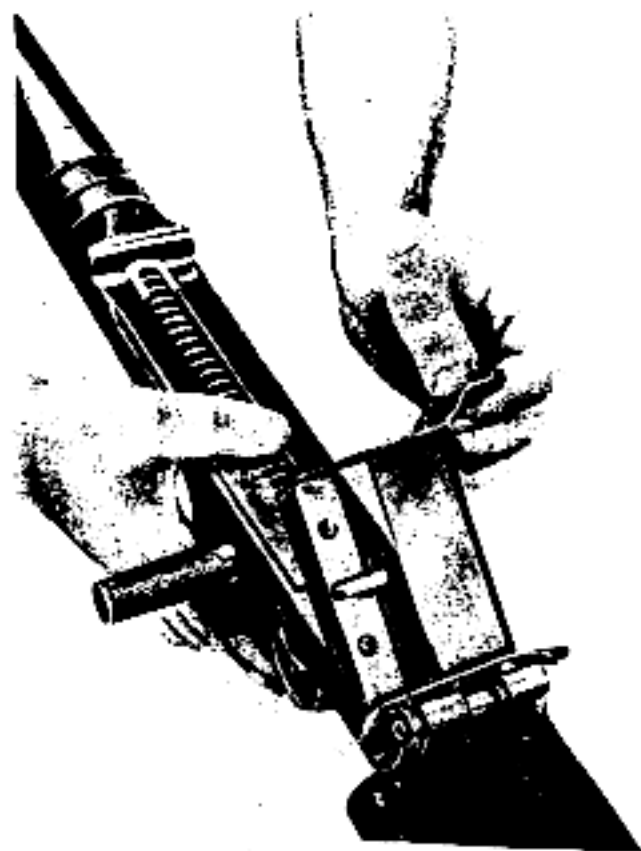
**Figure 25 – Removal of Feed Cover**

**GERMAN 7.9-MM DUAL PURPOSE MACHINE GUN MG34**

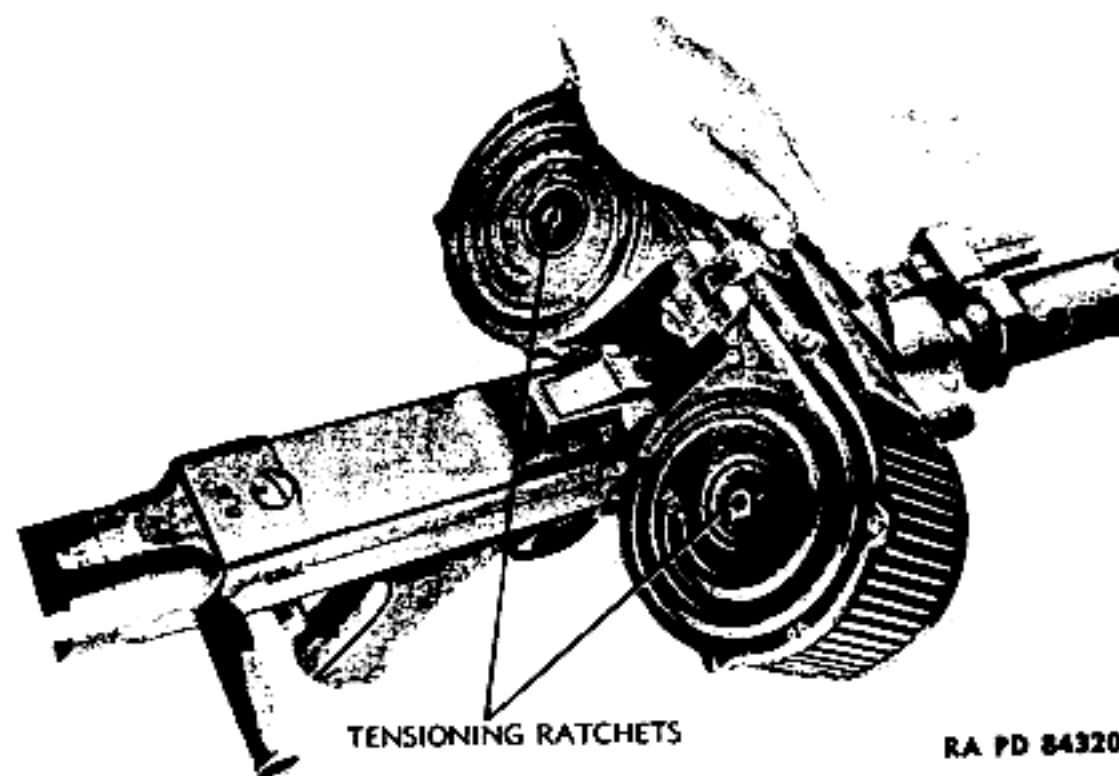
(3) **AUTOMATIC FIRE.** Push the trigger finger on the mount down (fig. 34), then pull the trigger handle. The machine gun will continue to deliver automatic fire as long as the handle is pulled and ammunition is fed into the gun. Between bursts, set the safety at **SAFE** (move it to rear to uncover letter "S" (fig. 31)).

**(4) ELEVATION AND TRAVERSE.**

(a) The front end of the cradle is carried on a swivel mounting at the junction of the three tripod legs, while the rear end is supported by the elevating gear. The front leg is telescopically adjustable, and is provided with a clamping lever for fixing the telescopic parts after they have been adjusted. A traversing arc, on which the elevating gear is carried by a traversing slide, acts as a brace between the two rear legs which are jointed, each joint being fitted with a clamping wing nut. An adjustable center stay provided with a clamping lever is connected between the traversing arc and the front leg.



RA PD 57346

**Figure 26 — Removal of Feed Block****OPERATION****Figure 27 — Mounting of 75-round Magazine****Figure 28 — Cocking Handle in Most Forward Position — Bolt Fully Home**

GERMAN 7.9-MM DUAL PURPOSE MACHINE GUN MG34



RA PD 57355

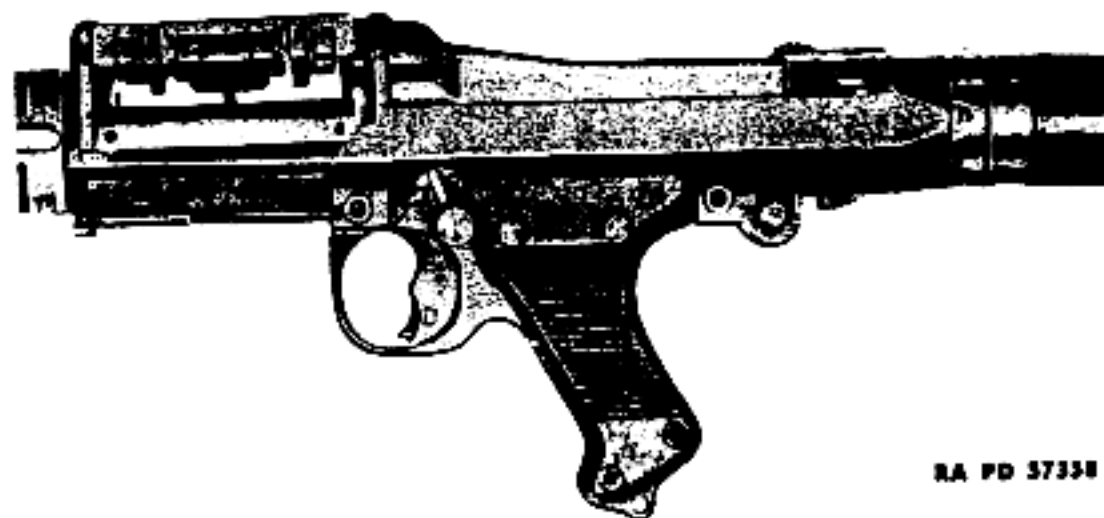
Figure 29 - Cocking Handle in Rearmost Position - Gun Cocked



RA PD 57354

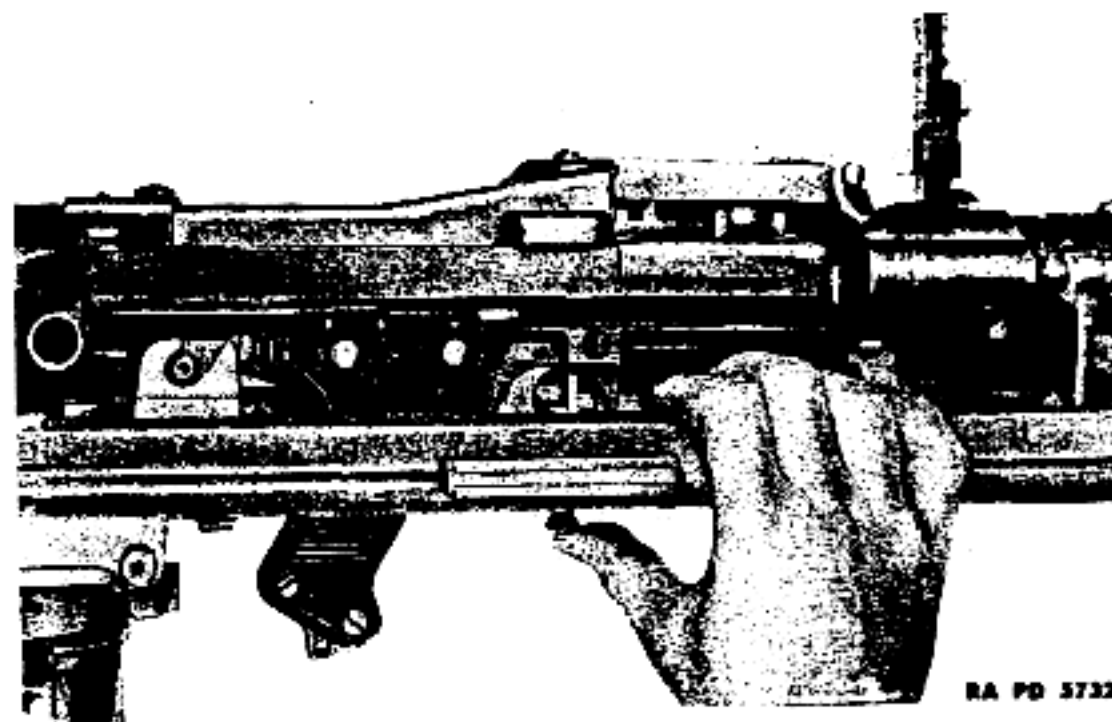
Figure 30 - Cocking Handle in Forward Position - Gun Cocked

OPERATION



RA PD 57358

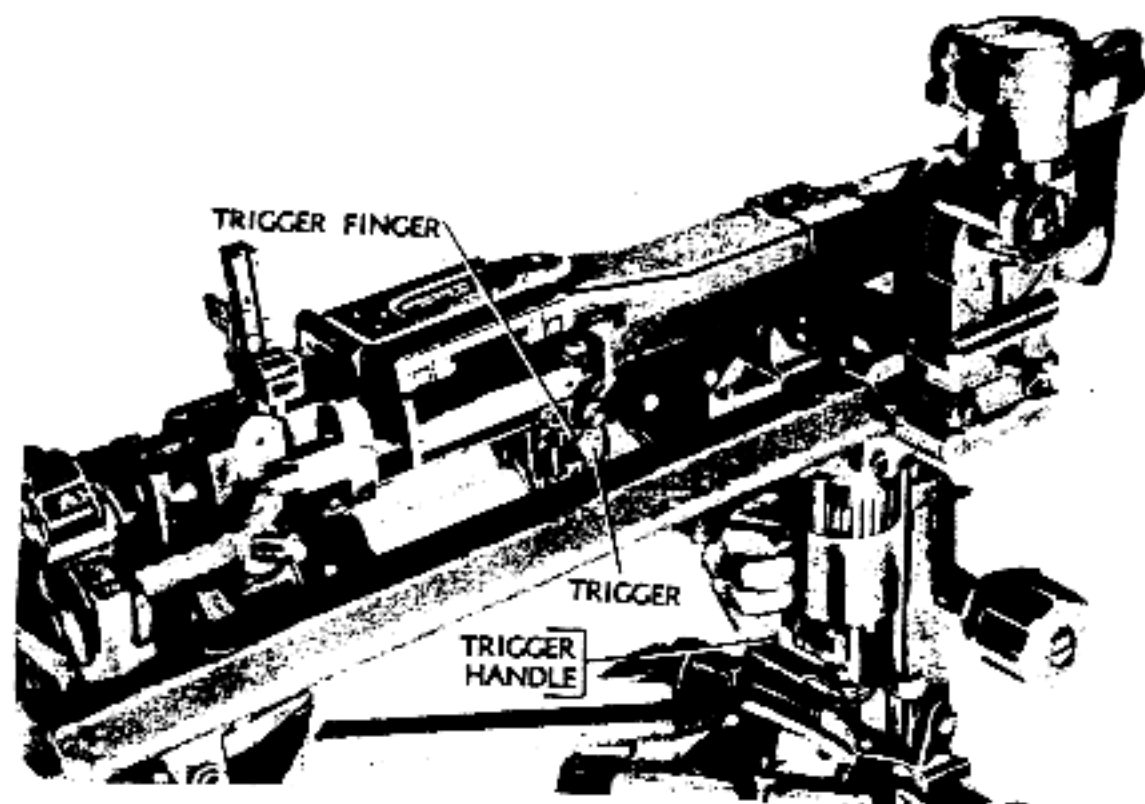
Figure 31 - Safety at Safe - Letter "S," Uncovered



RA PD 57326

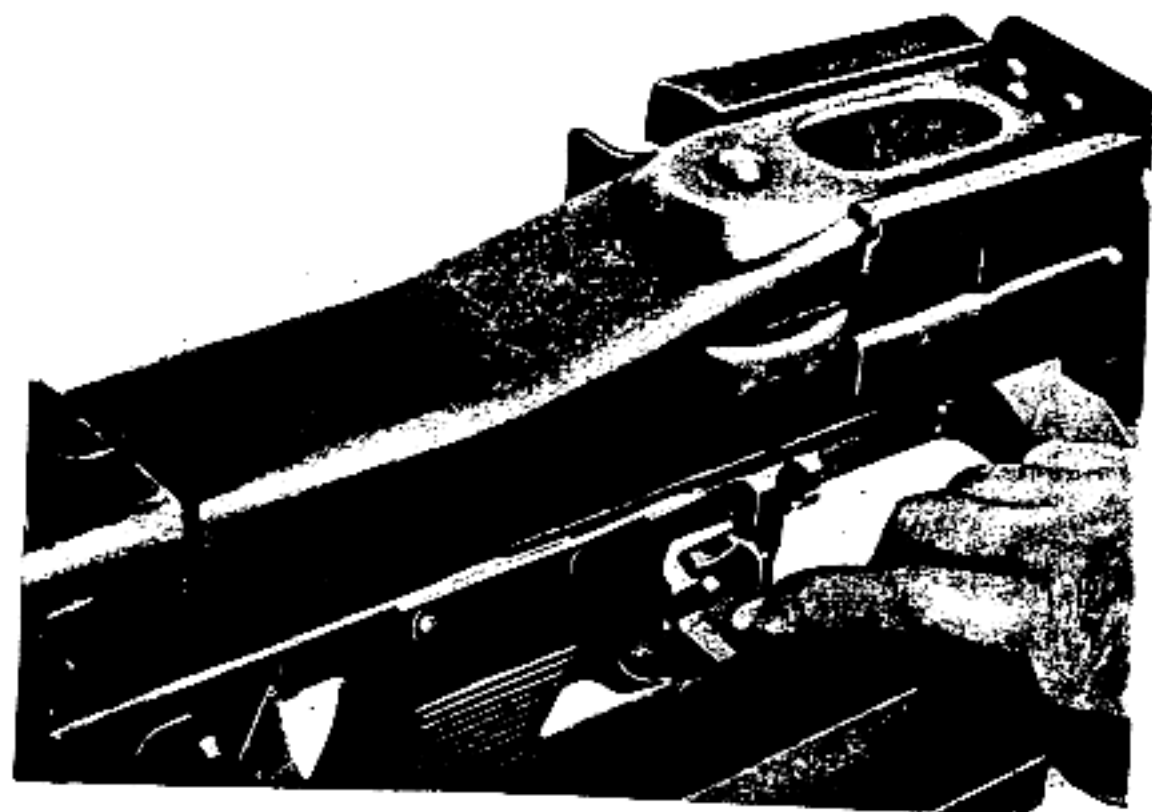
Figure 32 - Adjustment of Trigger Finger for Single Fire

GERMAN 7.9-MM DUAL PURPOSE MACHINE GUN MG34



RA PD 57327

Figure 33 - Firing of Machine Gun



RA PD 57325

Figure 34 - Adjustment of Trigger Finger for Automatic Fire

OPERATION

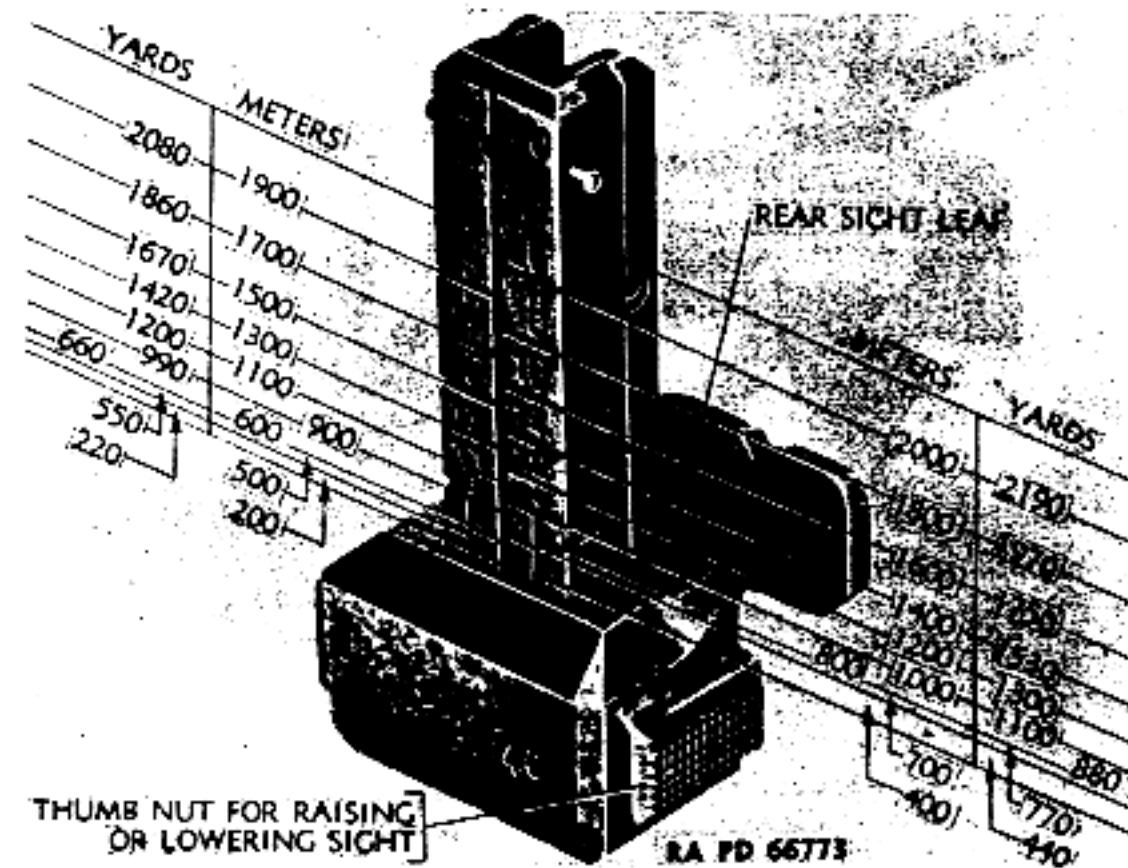
(b) Elevation is adjusted by a handwheel on the left of the elevating gear, while adjustments for line are made by shifting the traversing slide along the traversing arc by means of a handle on the right, in which an oil bottle is fitted. A wing nut is provided for clamping the elevating gear and a clamping lever for locking the traversing slide. Adjustable elevating and traversing stops are also provided to enable the gun to be elevated and traversed between predetermined limits. The traversing stops are arranged for the traversing arc, which is graduated to facilitate adjustment of the stops (fig. 36).

(c) In front of the elevating gear is an automatic searching fire device, operated by the recoil of the gun in the cradle, which causes a projection on the cradle slide to strike a roller on the device. Actuated in this manner, the device alternately elevates the cradle step by step, and depresses it similarly each time a shot is fired. The limits of the searching fire, and consequently the distance on the ground covered by it, can be increased or reduced by means of a graduated setting ring (fig. 36).

d. Metric and English Units.

(1) The divisions on the rear sight in meters and yards are shown in figure 35.

(2) The Overhead Firing Table and Table of Minimum Clearance are shown in figure 36 (ranges given in meters) and in figure 37 (ranges given in yards).



RA PD 66773

Figure 35 - Rear Sight - Meters and Yards

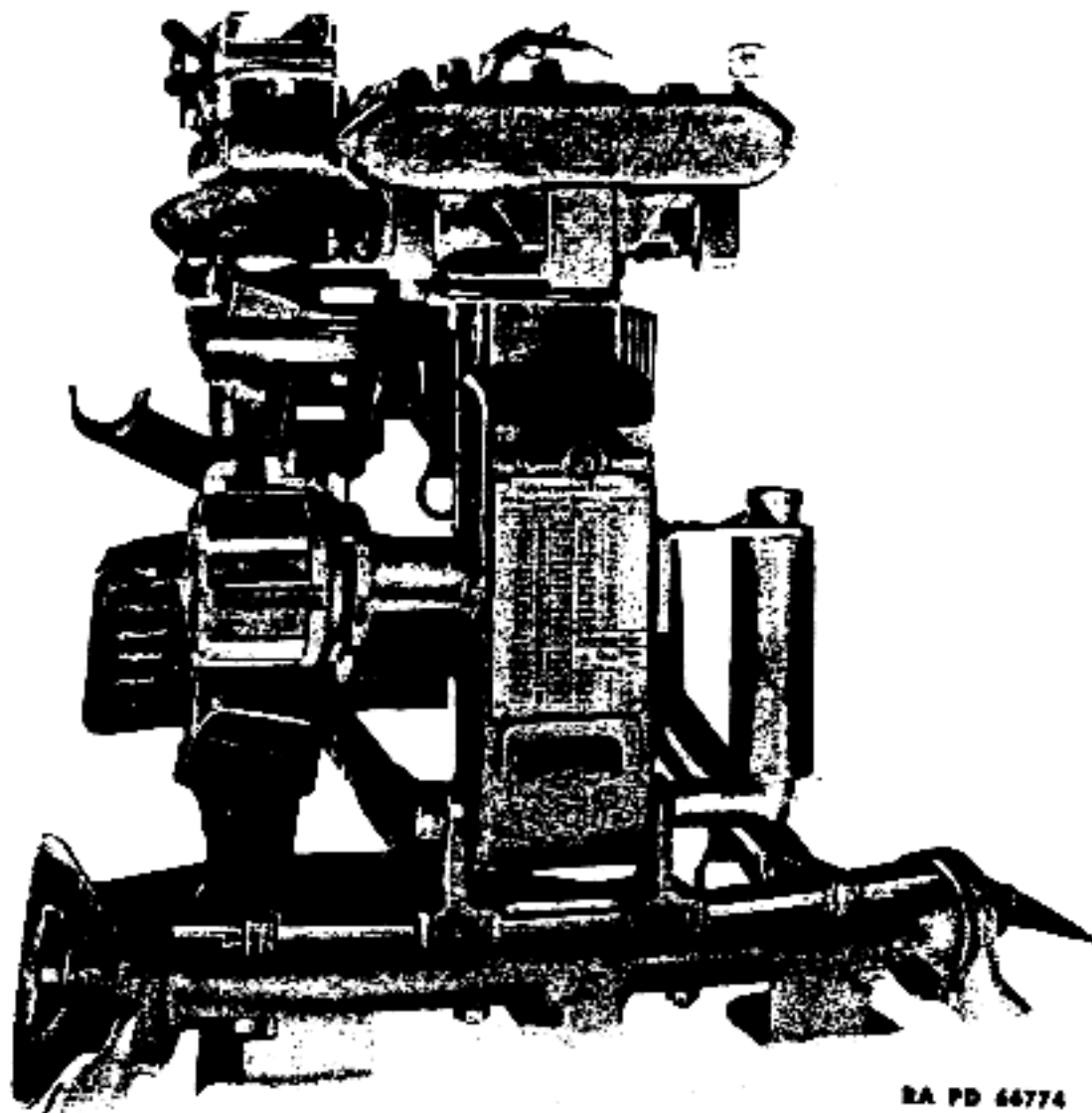


**GERMAN 7.9-MM DUAL PURPOSE MACHINE GUN MG34**

**10. UNLOADING THE MACHINE GUN.**

a. **Removal of Belt.** Cock the gun and set the safety at **SAFE** (fig. 31). Push the feed cover catch forward and raise the feed cover (fig. 18). Lift out the belt. See that there is no round in the barrel. Set the safety at **FIRE**. Grasp the cocking handle and pull the trigger, allowing the bolt to go slowly home.

b. **Removal of 50-round Belt Drum Magazine.** Cock the gun and set the safety at **SAFE** (fig. 31). Push the feed cover catch forward and raise the feed cover (fig. 18). Lift out the belt and disconnect the magazine from the gun. See that there is no round in the barrel. Set the safety at **FIRE**. Grasp the cocking handle and pull the trigger, allowing the bolt to go slowly home.



RA PD 46774

**Figure 36 – Overhead Firing Table and Table of Minimum Clearance – Ranges in Meters**

**OPERATION**

OVERHEAD FIRING TABLE			
DISTANCE TO OWN TROOPS	SAFETY		DISTANCE TO OWN TROOPS
	DIVISIONS	SIGHT	
55 YARDS	61	2250 YARDS	1970 YARDS
80	49	2030	2080
110	39	1800	2190
140	35	1730	2300
165	31	1550	2400
190	29	1500	2520
220	27	1450	2620
250	23	1350	2730
280	23	1350	2840
330	20	1250	2950
440	20	1250	3060
550	20	1250	3170
660	22	1300	3280
770	23	1350	3390
880	27	1450	
990	29	1500	
1100	21	1550	
1200	35	1730	
1300	37	1750	
1400	41	1860	
1500	44	1920	
1670	49	2030	
1750	55	2130	
1860	60		

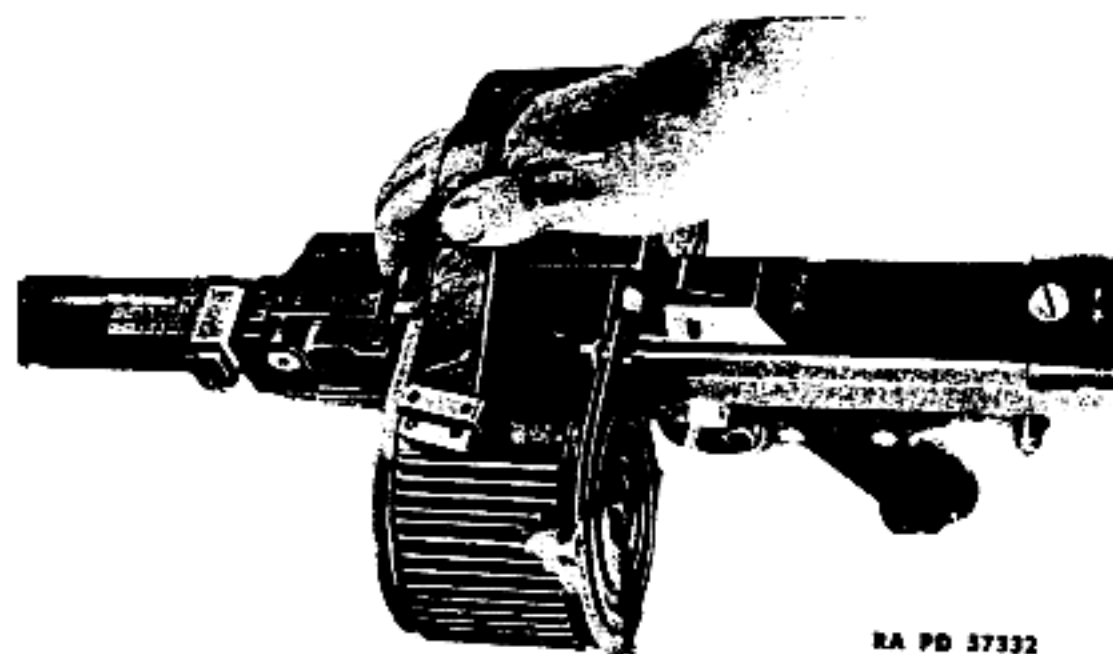
  

TABLE OF MINIMUM CLEARANCE		
TARGET	DEPTH	DOUBLE DEPTH
1300 YARDS	1	2
2190	2	4
2840	3	6
3280	4	8
3600	5	10

RA PD 84325

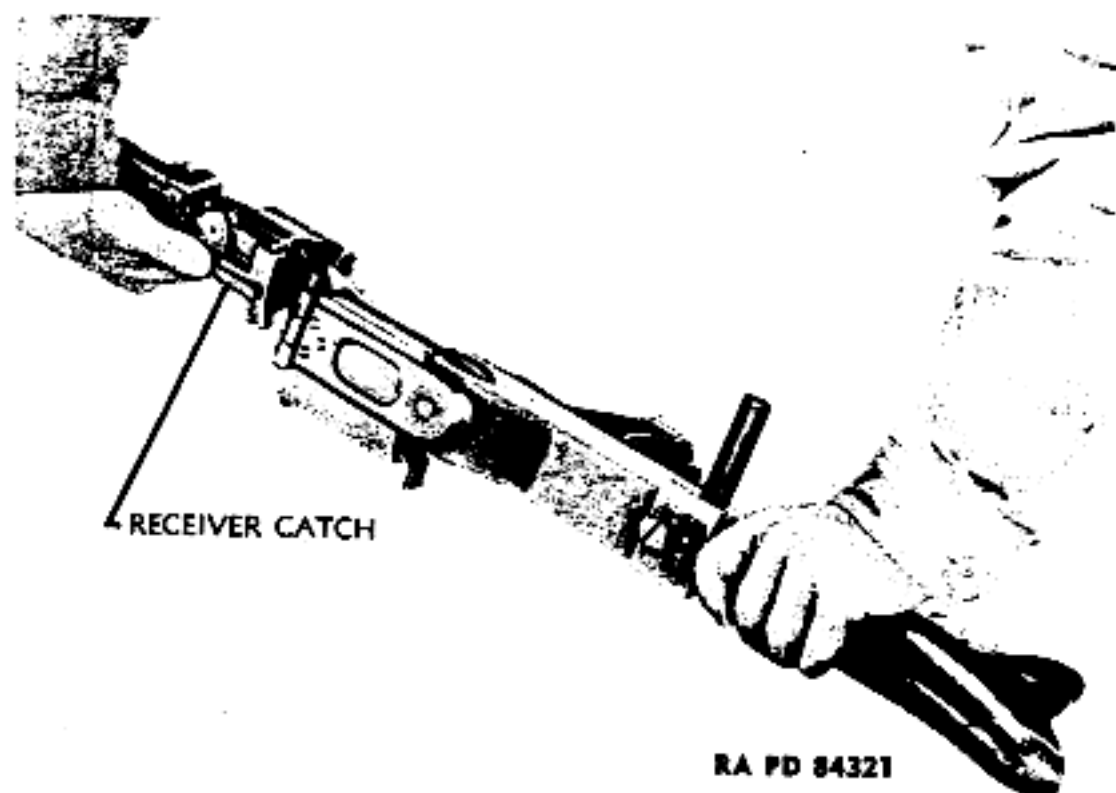
**Figure 37 – Overhead Firing Table and Table of Minimum Clearance – Ranges in Yards**

## GERMAN 7.9-MM DUAL PURPOSE MACHINE GUN MG34



RA PD 37332

Figure 38 — Removal of 75-round Magazine

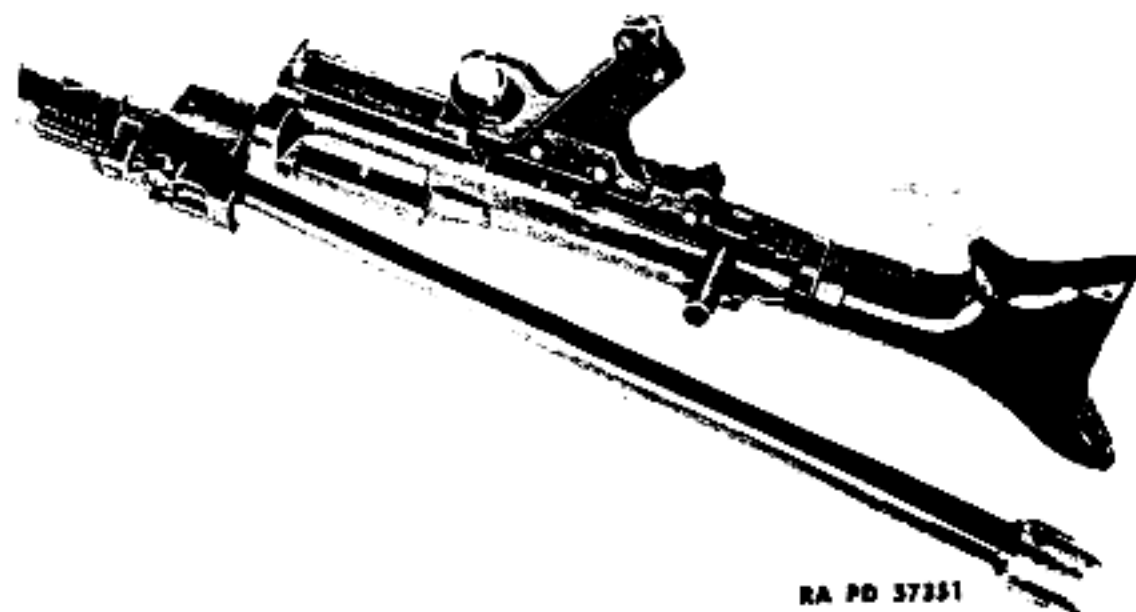


RA PD 84321

Figure 39 — Unlocking and Rotating Receiver

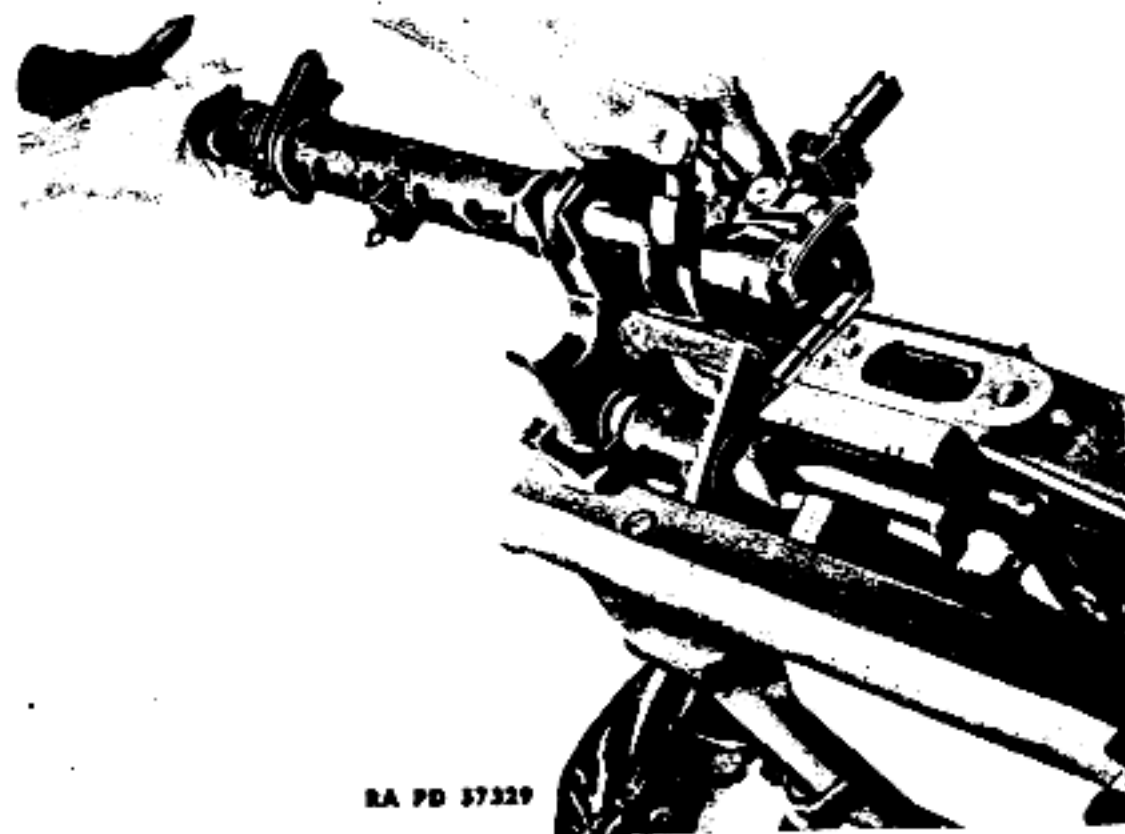
c. Removal of 75-round Spring-operated Drum Magazine. Cock the gun and set the safety at SAFE (fig. 31). Place the right hand under the strap on the magazine, and remove the magazine by pressing the hand against the strap and pushing with the fingers against the latch on top of the magazine (fig. 38).

## OPERATION



RA PD 37351

Figure 40 — Sliding Barrel out of Barrel Casing



RA PD 37329

Figure 41 — Unlocking of Receiver Catch and Rotating Barrel Casing

## 11. CHANGING BARRELS.

a. General. The barrel must be changed after about 250 rounds have been fired continuously or with only short intervals between bursts.

GERMAN 7.9-MM DUAL PURPOSE MACHINE GUN MG34

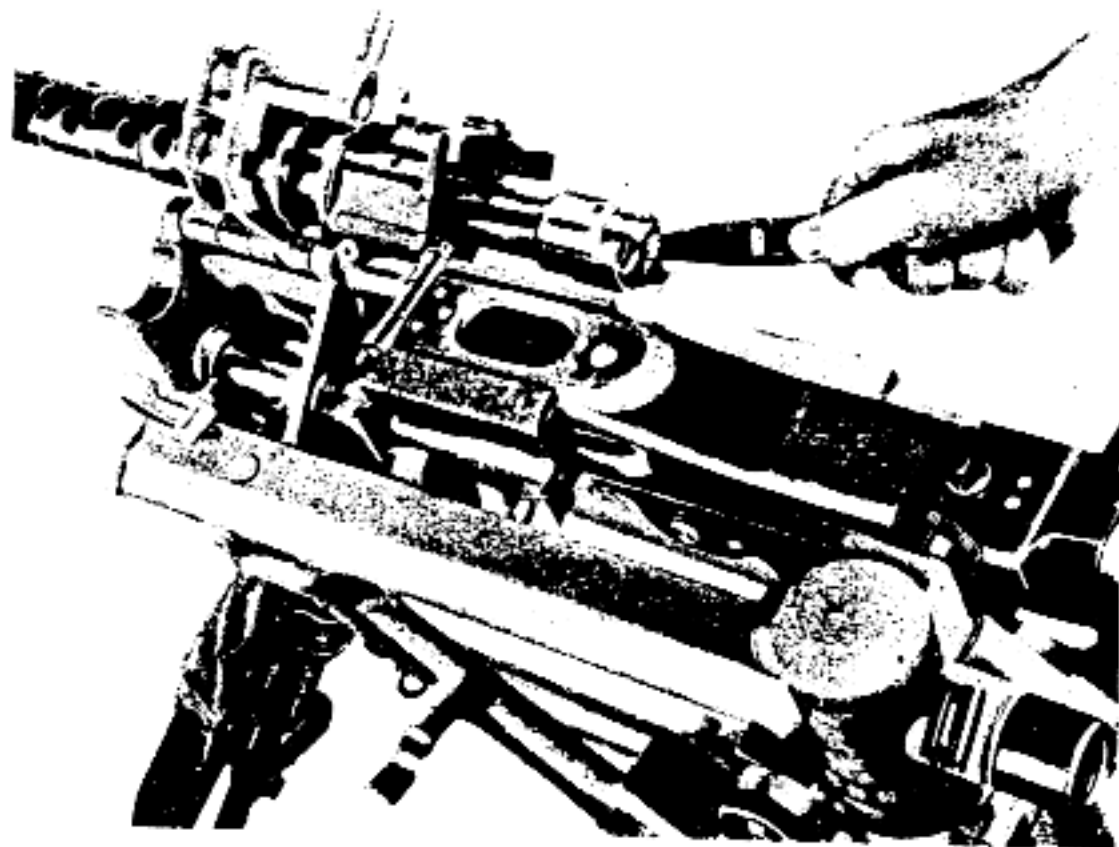


Figure 42 — Removing a Hot Barrel

RA PD 57328

b. Changing Barrels When Machine Gun Is Mounted on the Bipod, Antiaircraft Tripod, or Tripod Mount AA Adapter.

(1) Unload the gun (par. 10). Cock the gun and set the safety at **SAFE**. Depress the receiver catch and rotate the receiver nearly 180 degrees (fig. 39).

(2) Raise the muzzle end of the gun to allow the barrel to slide out (fig. 40). Insert a fresh barrel and rotate the receiver until the receiver catch snaps into position. Set safety at **FIRE**. Grasp the cocking handle and pull the trigger, allowing the bolt to move slowly home.

c. Changing Barrels When Machine Gun Is Mounted on Tripod Mount.

(1) Unload the gun (par. 10). Cock the gun and set the safety at **SAFE**. Depress the receiver catch by means of the cranked lever, and rotate the barrel casing nearly 180 degrees (fig. 41).

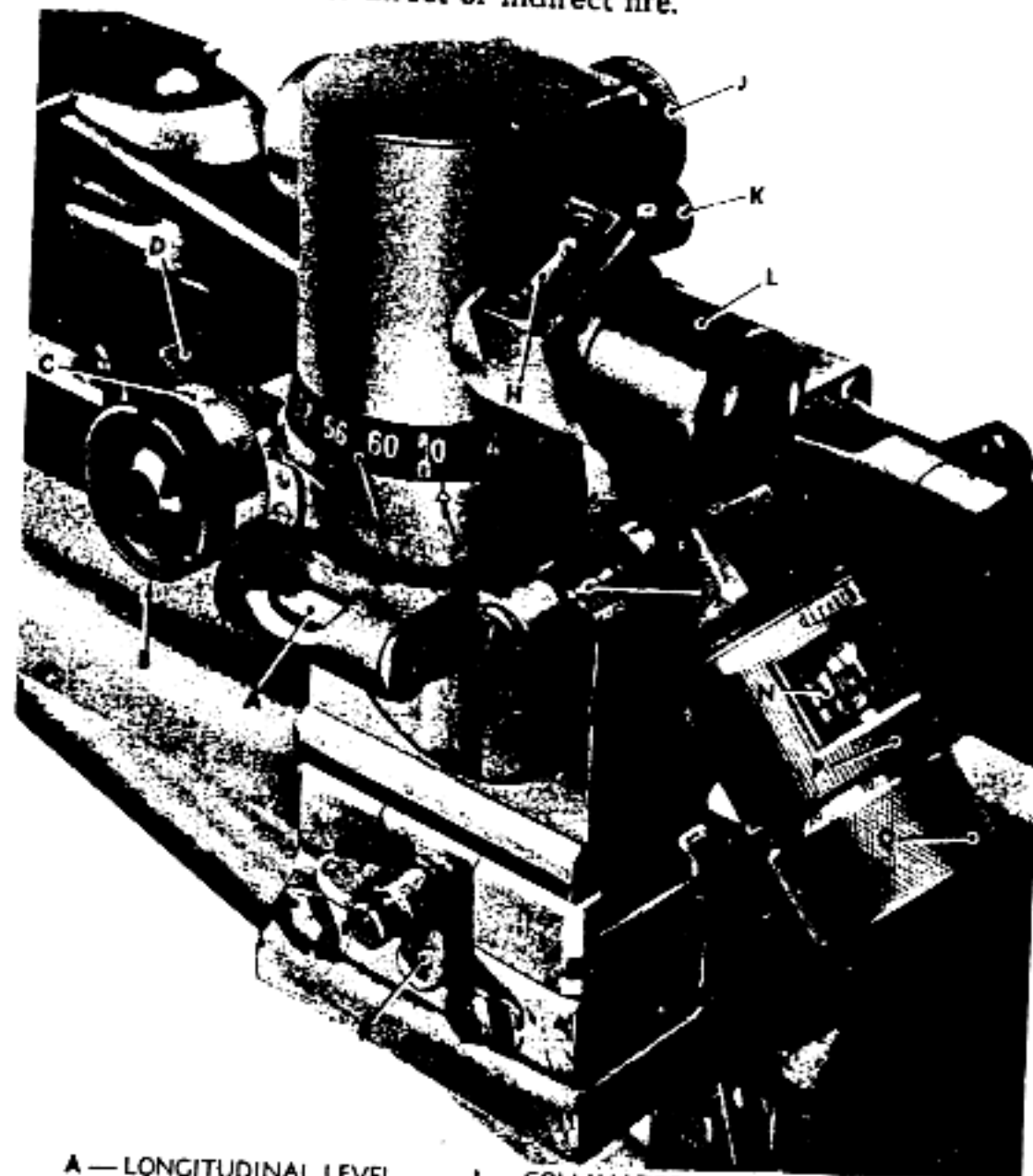
(2) Remove the hot barrel with the leading tab or any other convenient tool (fig. 42). Insert a fresh barrel and rotate the barrel casing until the receiver catch snaps into position. Set safety at **FIRE**. Grasp the cocking handle and pull trigger, allowing bolt to move slowly home.

Section III  
SIGHTING EQUIPMENT

Telescopic sight for the German 7.9-mm dual purpose machine gun MG34 ..... Paragraph 12

12. TELESCOPIC SIGHT FOR THE GERMAN 7.9-MM DUAL PURPOSE MACHINE GUN MG34.

a. The telescopic sight (figs. 43 to 45) is used for aiming the machine gun in either direct or indirect fire.



- |                        |                                  |
|------------------------|----------------------------------|
| A — LONGITUDINAL LEVEL | J — COLLIMATOR                   |
| B — AZIMUTH KNOB       | K — COLLIMATOR CLAMPING SCREW    |
| C — AZIMUTH MICROMETER | L — EYEPIECE                     |
| D — THROWOUT LEVER     | M — CROSS LEVEL                  |
| E — MICROMETER INDEX   | N — ELEVATION DRUM (DIRECT FIRE) |
| F — AZIMUTH SCALE      | P — SHUTTER                      |
| G — SCALE INDEX        | Q — ELEVATING KNOB               |
| H — LIGHT WINDOW       | R — WING NUT                     |

RA PD 57062

Figure 43 — Telescopic Sight Assembled on German 7.9-mm Dual Purpose Machine Gun MG34

## GERMAN 7.9-MM DUAL PURPOSE MACHINE GUN MG34

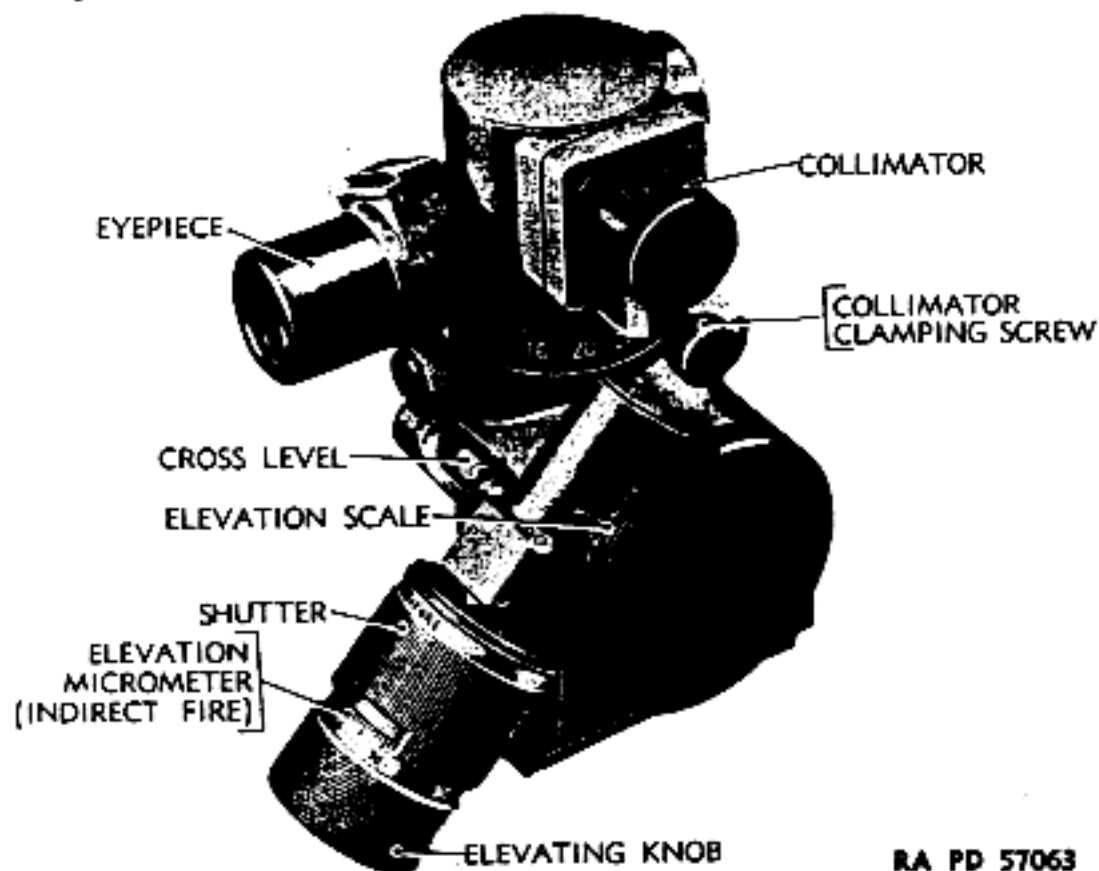


Figure 44 — Telescopic Sight for German 7.9-mm Dual Purpose Machine Gun MG34 — Rear View

b. The sight consists essentially of a telescope which can be moved in azimuth and elevation in relation to the machine gun. The telescope has a 3-power magnification and a field of view of 13 degrees 30 minutes. A graduated reticle pattern is seen superimposed on the target image when looking through the eyepiece. The light window near the eyepiece admits light for reticle illumination when the sight is used at night. A removable eyeshield (not shown in the figures) fits over the eyepiece; the eyeshield is removed to permit sighting while wearing a gas mask.

c. The telescope is moved in azimuth (traversed) by turning the azimuth knob. For rapid motion through large azimuth angles, the telescope can be turned directly by holding the throw-out lever down. Azimuth angles from 0 to 6400 mils are read on the azimuth scale (coarse, 100-mil divisions) and azimuth micrometer (fine, 1-mil divisions). The azimuth micrometer has two rows of graduations. The inner row only is used for reading azimuth angles in indirect fire; either row is used in setting in small deflection angles for direct fire.

d. The telescope is moved in elevation by turning the elevating knob. Elevation can be read either in meters for direct fire, or in

## SIGHTING EQUIPMENT

mils for indirect fire. When the shutter (figs. 43 and 44) is set to "DIREKT" (direct), the elevation drum carrying the meter graduations is exposed. When the shutter is set to "INDIREKT" (indirect), the elevation drum is covered and an index is brought into position for reading the elevation micrometer. Elevation in mils is read on the elevation scale (coarse, 100-mil divisions) and elevation micrometer (fine, 1-mil divisions). The 300-mil setting corresponds to zero elevation. The elevation scale graduations read from 0 to 10 (0 to 1000 mils) for actual elevations of from minus 300 to plus 700 mils.

e. The collimator traverses with the telescope, but can be elevated or depressed independently of the telescope. When sighting into the collimator, a cross is seen which remains stationary as though it were at an infinite distance. Aiming is accomplished by lining this cross up with the target. The principal use of the collimator is to establish a safety point of minimum elevation for firing over a crest, or over the heads of friendly troops.

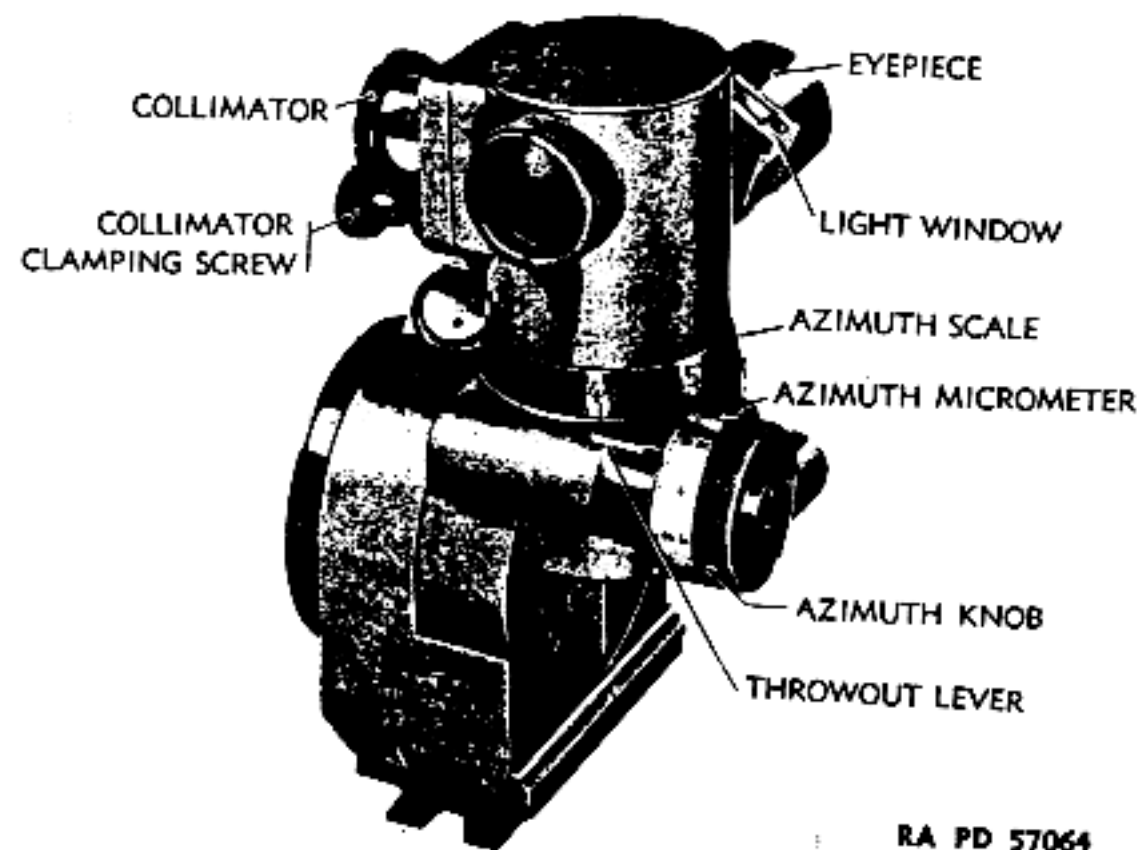


Figure 45 — Telescopic Sight for German 7.9-mm Dual Purpose Machine Gun MG34 — Front View

f. Operation, Direct Fire.

(1) Turn the shutter to "DIREKT" (fig. 43), exposing the elevation drum. Set the required elevation for range, in meters, on the

### GERMAN 7.9-MM DUAL PURPOSE MACHINE GUN MG34

elevation drum by turning the elevating knob. For conversion of meters to yards, see figures 36 and 37.

(2) Set the azimuth scale and azimuth micrometer to ZERO. Deflections up to 100 mils right or left can be set on the azimuth micrometer.

(3) Keep the machine gun leveled laterally to eliminate error due to cant. The machine gun is properly leveled when the cross-level bubble is centered.

(4) Traverse and elevate the machine gun while looking through the telescope eyepiece until the target is centered in the telescope reticle.

#### g. Operation, Indirect Fire.

(1) Turn the shutter to "INDIREKT" (fig. 44), exposing the elevation micrometer. Set the required elevation, in mils, on the elevation scale and elevation micrometer. The required setting for any given target will be the angle of site (in mils) plus the range elevation (in mils) plus 300 mils. Range elevation in mils can be read on the Overhead Firing Table (figs. 36 and 37).

(2) Set the azimuth scale and azimuth micrometer to the required deflection.

(3) Keep the machine gun leveled laterally to eliminate error due to cant. The machine gun is properly leveled when the cross-level bubble is centered.

(4) Traverse the machine gun while looking through the telescope eyepiece until the aiming point is centered in the telescope reticle. Elevate the machine gun until the cross-level bubble is centered.

### Section IV

## MALFUNCTIONS AND CORRECTIONS

	Paragraph
General .....	13
Immediate action .....	14
Malfunctions and corrections.....	15

### 13. GENERAL.

a. This section is intended to provide necessary instructions in immediate action, and malfunctions and corrections. These instructions should be studied before any firing is done by the individual.

### 14. IMMEDIATE ACTION.

a. Immediate action is the immediate and automatic application of a remedy. It is to be applied immediately and automatically to a gun that jams, or otherwise malfunctions, in actual or simulated combat. When a stoppage occurs during firing, perform the immediate

## MALFUNCTIONS AND CORRECTIONS

action described below, or such portions thereof as are required to remedy the stoppage.

b. Failure of Gun to Fire. If the loaded gun fails to fire when the trigger is squeezed, proceed immediately as follows:

- (1) Wait 5 seconds before opening chamber.
- (2) Cock the gun by a sharp, quick pull on the cocking handle.
- (3) If the round is ejected, squeeze the trigger and fire.
- (4) If the round is not ejected, set the safety at SAFE, and unload the gun.
- (5) Turn the gun over on its side and shake it to allow the round to fall out. If the round does not fall out, remove it by pushing a rod through the bore from the muzzle end, making certain that the gun points in a safe direction.
- (6) Load the gun and resume firing.

## 15. MALFUNCTIONS AND CORRECTIONS.

a. Proper care of the gun before, during, and after firing will usually eliminate most stoppages. Stoppages or other malfunctions which cannot be remedied by the application of immediate action should be dealt with in accordance with instructions described in the following paragraphs.

b. Feed Stoppage or Malfunction. It is dangerous to investigate a feed stoppage or malfunctions by raising the feed cover without first cocking the gun or retaining a hold on the cocking handle. Should a live round remain in the chamber, the raising of the feed cover would allow the bolt to continue forward to fire a round, thus causing damage. Should a stoppage occur during firing, cock the gun and move the safety to SAFE. Then, raise the cover and remove the magazine or belt. If the gun cannot be cocked, apply a backward pull on the cocking handle, at the same time raising the feed cover and unloading the gun. The gun can then be cocked.

### c. Failure to Fire.

(1) CAUSES. Failure to fire is generally caused by:

- (a) Defective ammunition.
- (b) Defective firing pin or firing pin spring.
- (c) Bolt not fully closed.

### (2) REMEDIES.

(a) If the primer of the round is deeply indented, the round is defective and must be discarded.

(b) If the primer is not indented or only slightly indented, the firing pin or firing pin spring may be worn or broken, or the bolt may not have been fully home. Check for dirt or any other obstruction on the bolt and receiver, and in breech end of barrel. Check for a ruptured case in the chamber. Remove all obstructions.

**GERMAN 7.9-MM DUAL PURPOSE MACHINE GUN MG34**

(c) If driving spring is too weak to drive the bolt fully home, turn the gun over to ordnance personnel. If firing pin or firing pin spring is worn or broken, turn the bolt over to ordnance personnel.

**d. Failure to Feed.**

(1) **CAUSES.** Failure to feed may be caused by:

- (a) Defective magazine or defective belt.
- (b) Insufficient recoil of bolt to pick up a new round.
- (c) Broken feed piece on top of bolt.

(2) **REMEDIES.**

(a) If the magazine does not feed cartridges into gun because of defective spring, follower, or mouth, it should be replaced.

(b) If belt does not feed cartridges into gun because it is deformed or broken, it should be discarded.

(c) If cartridges are not fed into gun because feed piece is broken, turn the bolt over to ordnance personnel.

(d) Insufficient recoil may be due to reduced blast boosting or to obstruction in receiver. Adjust the blast booster the required number of notches until sufficient recoil is obtained. Remove the receiver from gun and eliminate the obstruction.

**e. Failure to Extract.**

(1) **CAUSES.** Failure to extract is generally caused by:

- (a) Dirty chamber.
- (b) Dirty ammunition.
- (c) Broken extractor.

(2) **ACTION.**

(a) When failure to extract occurs, the bolt may be found fully home with a spent case in the chamber. Generally, most failures to extract can be remedied by pulling the cocking handle smartly to the rear. If this does not remove the case, use a cleaning rod.

(b) Sometimes the empty case will be left in the chamber, the extractor ripping through the base of the cartridge. When this occurs, the bolt generally will attempt to feed a fresh cartridge into the chamber. It will then be necessary to remove this round before the spent case can be removed.

(c) Where a dirty chamber or dirty ammunition is indicated, clean the chamber and discard or clean the dirty ammunition. The presence of even invisible particles of dust or sand in the chamber or on ammunition will cause failure to extract. It is advisable to oil the belt with paraffin wax if cartridges are to be left in it for more than a short period. A belt once oiled can be used 10 times before oiling again.

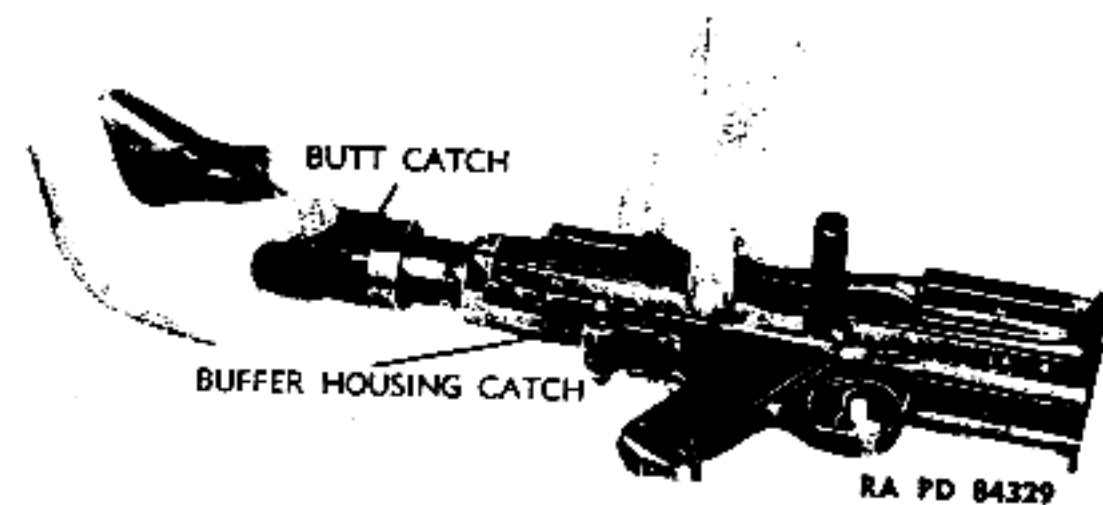
**f. Gun Fires Double or Triple Shots When Semiautomatic Trigger Is Pulled.** The principal cause of this trouble is a recoil of the bolt sufficient to feed the succeeding round, but not enough to engage the sear. Adjust the blast booster the required number of notches to give the proper recoil.

**Section V  
DISASSEMBLY AND ASSEMBLY**

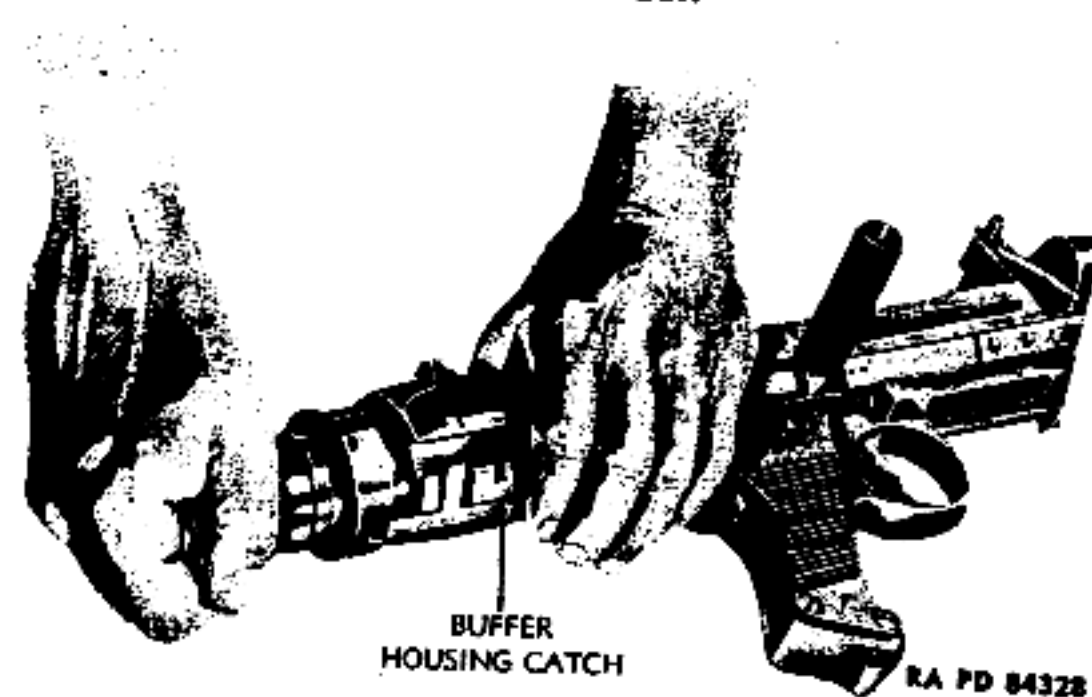
General .....	Paragraph
Disassembly .....	16
Assembly .....	17
	18

**16. GENERAL.**

a. Before performing the following operations, make certain that the gun has been unloaded and removed from the mount. The using arms is permitted to perform only such disassembly and assembly operations as are given below. All other disassembly and assembly operations must be performed by ordnance maintenance personnel.



**Figure 46 — German 7.9-mm Dual Purpose Machine Gun MG34 — Removal of Butt**



**Figure 47 — Unlocking Buffer**

GERMAN 7.9-MM DUAL PURPOSE MACHINE GUN MG34

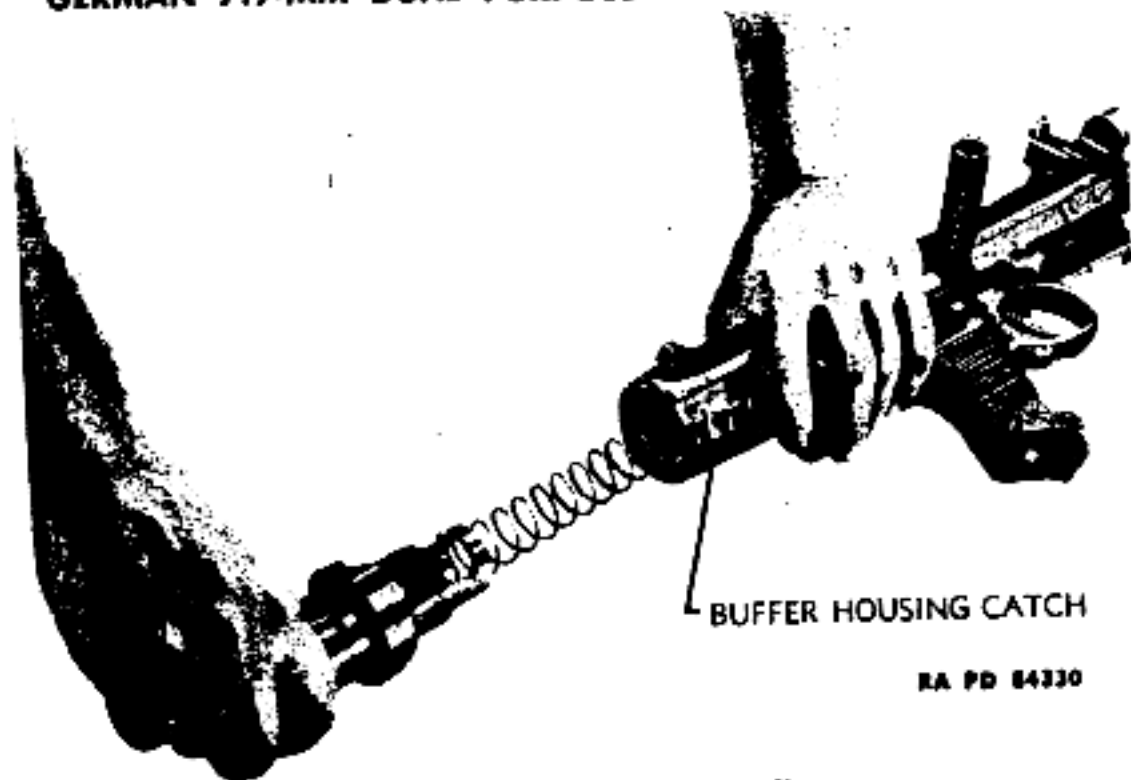


Figure 48 - Removal of Buffer

RA PD 84330

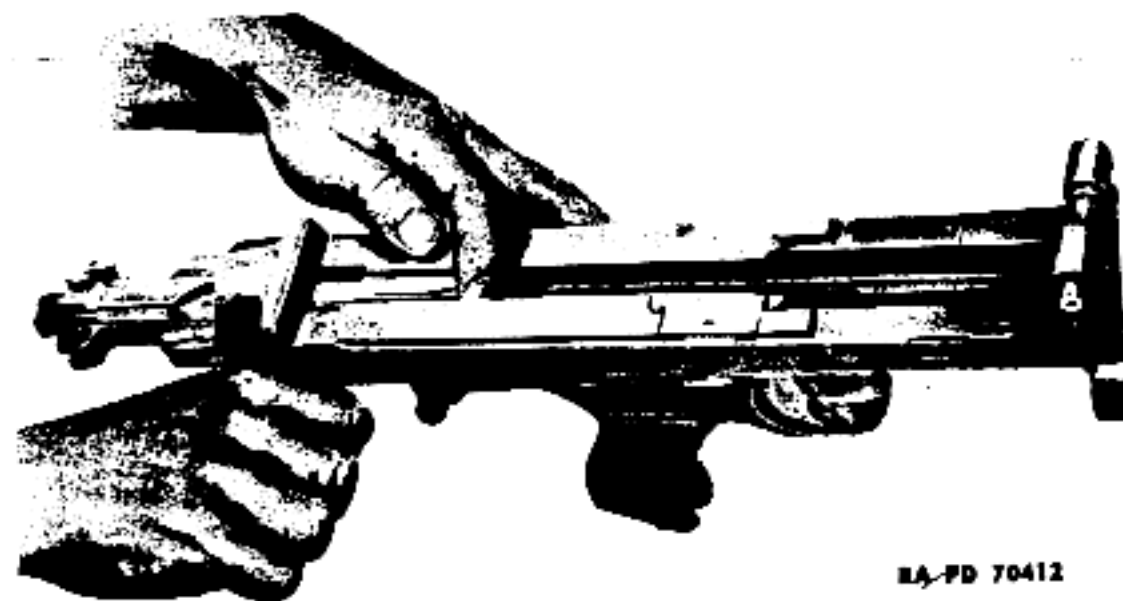


Figure 49 - Removal of Bolt

RA PD 70412

17. DISASSEMBLY.

a. **Butt Stock.** Press the butt catch below the butt, rotate the butt one quarter of a turn and remove it (fig. 46).

b. **Feed Cover and Feed Block.** Before proceeding, make certain the bolt is forward and fully home. Then press the feed cover catch forward and raise the cover (fig. 18). Press the feed cover axis pin to the left and remove the feed cover (fig. 25). Raise the feed block and remove it (fig. 26).

DISASSEMBLY AND ASSEMBLY

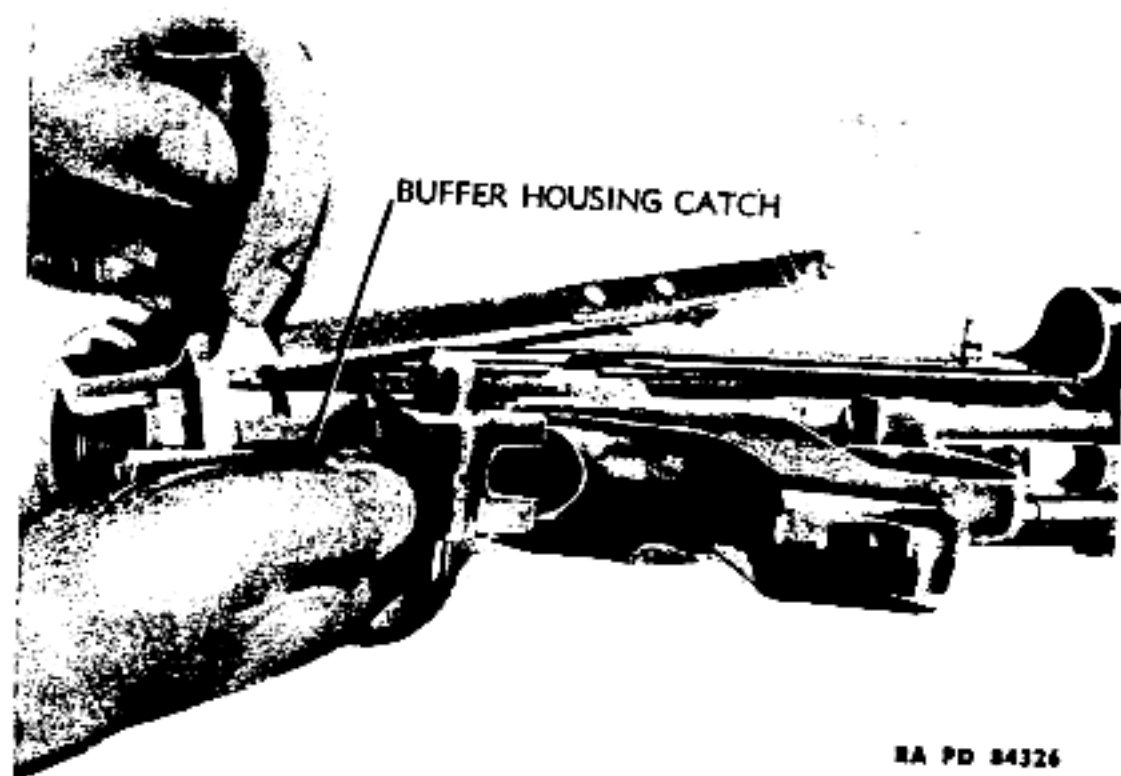


Figure 50 - Removal of Cocking Handle

RA PD 84326

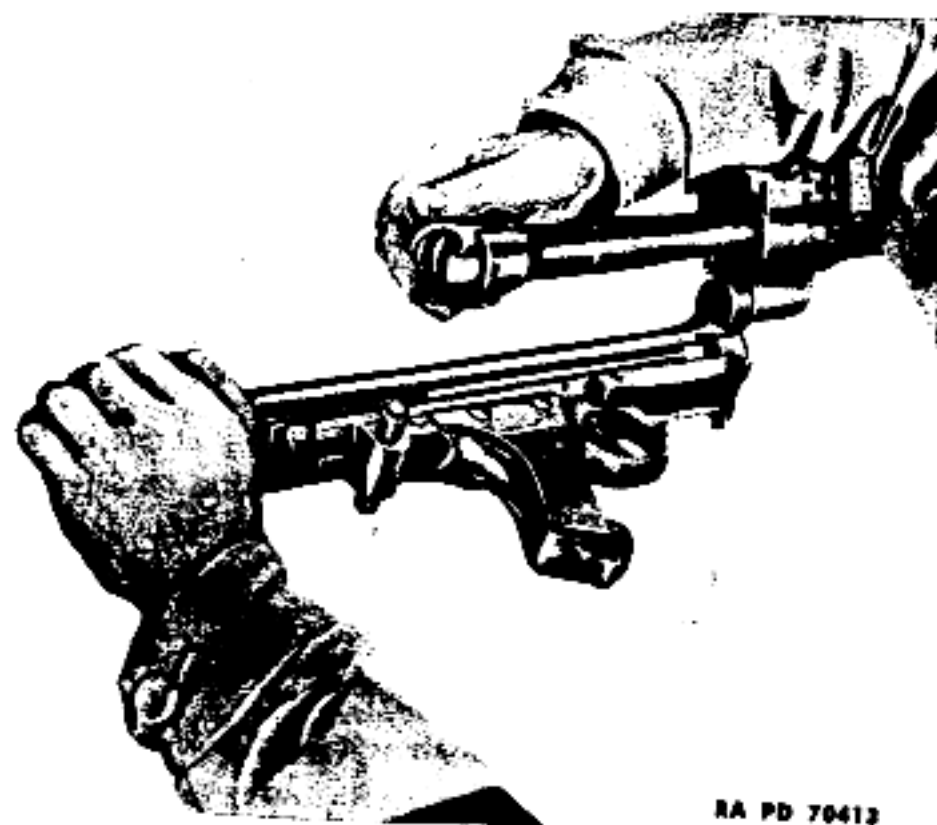


Figure 51 - Removal of Barrel

RA PD 70413

## GERMAN 7.9-MM DUAL PURPOSE MACHINE GUN MG34

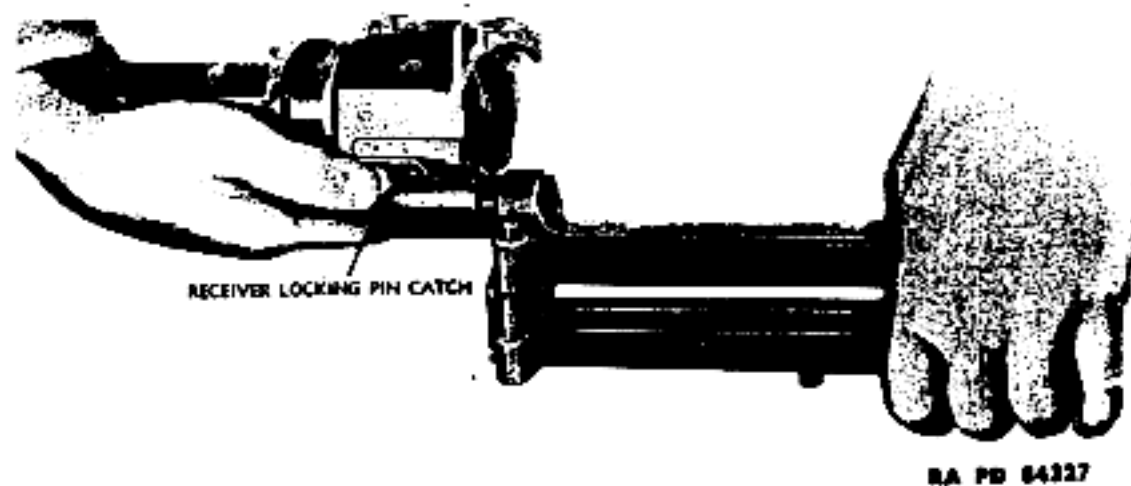


Figure 52 — Removal of Barrel Casing From Receiver

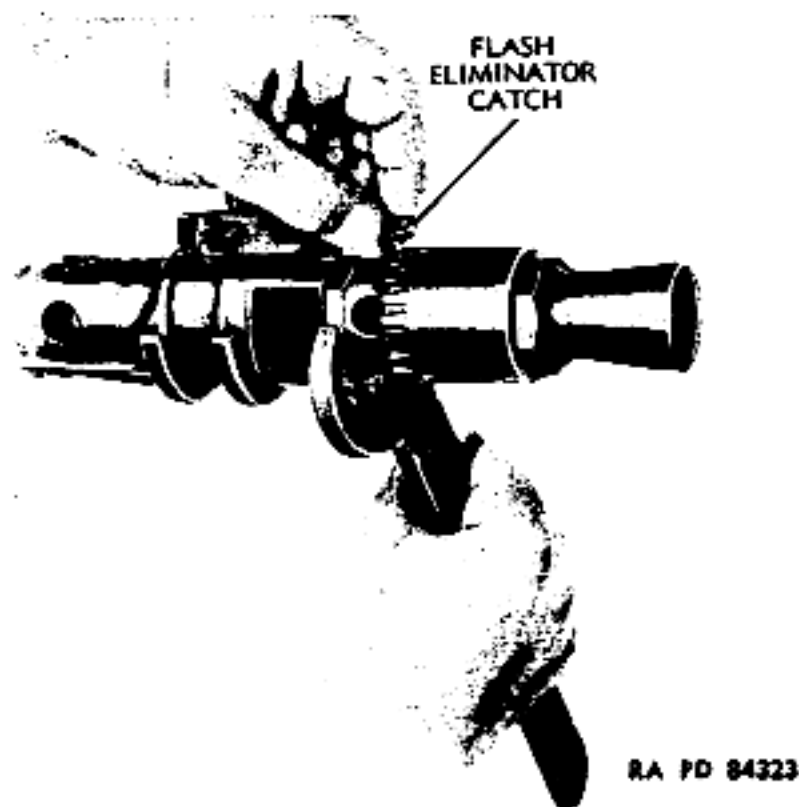


Figure 53 — Removal of Blast Trap and Flash Eliminator

c. **Buffer Housing.** Press the buffer housing catch beneath the rear end of the receiver, rotate the buffer housing one quarter turn counterclockwise (fig. 47) and remove the housing (fig. 48), taking care not to let the spring fly out.

d. **Bolt and Cocking Handle.**

(1) Pull the cocking handle to the rear and remove the bolt from the receiver (fig. 49).

(2) Press the buffer housing catch and remove the cocking handle (fig. 50).

e. **Removal of Barrel.** Depress the receiver catch (fig. 39), rotate the body about 180 degrees, and remove the barrel (fig. 51).

## DISASSEMBLY AND ASSEMBLY

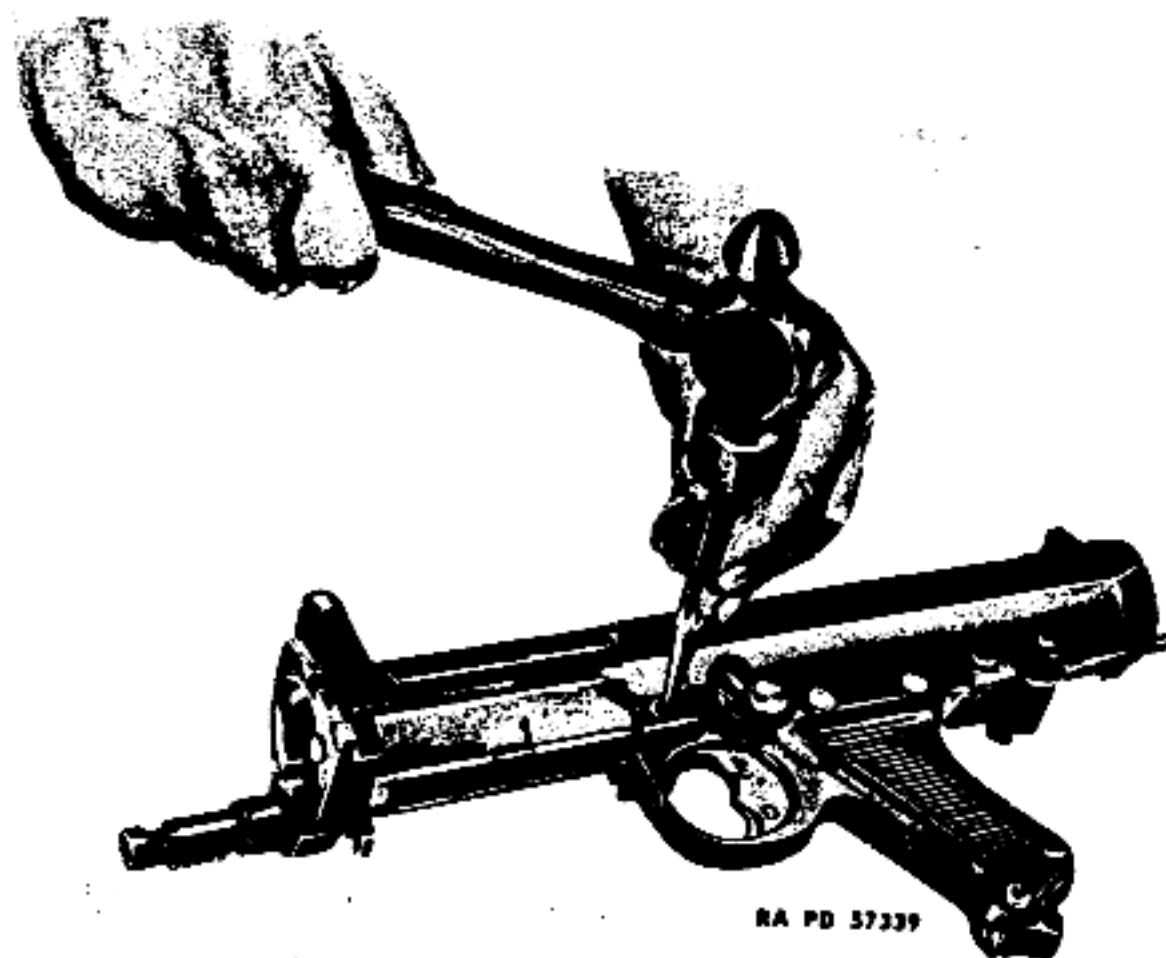


Figure 54 — Removal of Trigger Housing Group

f. **Removal of Barrel Casing.** Depress the receiver locking pin catch and remove the barrel casing from the receiver (fig. 52).

g. **Flash Eliminator and Blast Trap.** Raise the front end of the flash eliminator catch and with an open wrench (or by hand) and unscrew the flash eliminator together with blast trap (fig. 53). The threads are right-hand.

h. **Trigger Housing.** With a drift or any suitable tool, drive out the split pins (fig. 54) and then, the split pin retainers. Remove the trigger housing from the receiver. The trigger housing should not be removed unless absolutely necessary.

i. The chief components of the machine gun are shown in figure 55.

## 18. ASSEMBLY.

a. Prior to assembly, all groups must be free of dirt, rust, and other extraneous matter. Metal parts in contact must be covered with a light film of OIL, lubricating, preservative, light. Assembly is in the reverse order of disassembly. However, the following instructions pertaining to certain assembly operations should be noted:

(1) See that there is no round in the barrel.

(2) When inserting the bolt into the body, push the ejector fully forward and pull the trigger to allow bolt to be moved forward.



GERMAN 7.9-MM DUAL PURPOSE MACHINE GUN MG34

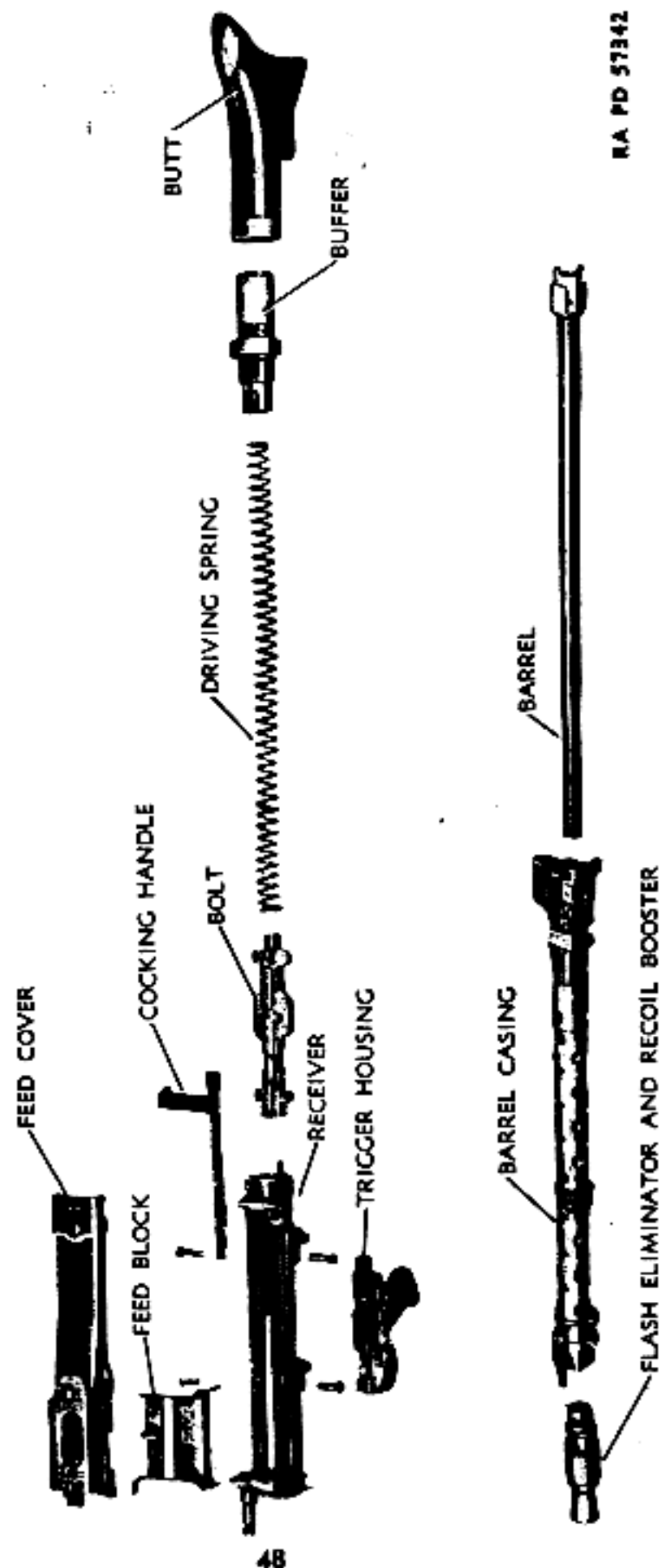


Figure 55 - Chief Components of the Machine Gun

Section VI

CARE AND PRESERVATION

	Paragraph
General .....	19
Cleaning of machine gun received from storage.....	20
Care in garrison and camp.....	21
Care preparatory to firing.....	22
Care on the range and in the field.....	23
Care after firing.....	24
Preparation for storage.....	25

19. GENERAL.

a. Proper functioning and accuracy of firing depend largely on care, cleaning, and oiling. The weapon should be checked daily for cleanliness and lubrication in garrison or camp, on the range, and in the field. The following instructions should be carefully observed.

20. CLEANING OF MACHINE GUN RECEIVED FROM STORAGE.

a. Machine guns and mounts which have been stored in accordance with instructions given in paragraph 25, will be coated with either OIL, lubricating, preservative, light, or COMPOUND, rust-preventive, light. Machine guns received from storage will usually be coated with a heavy, rust-preventive compound. Use SOLVENT, dry-cleaning, to remove all traces of the compound. Apply the solvent with rag swabs to large parts, and as a bath for small parts. Take care to remove the compound from all recesses in which springs or plungers operate. After removing all traces of the compound, allow the parts to dry, and then wipe with a clean, dry rag.

b. Persons handling parts after such cleaning should wear gloves to avoid leaving finger marks which are acid and usually start corrosion. SOLVENT, dry-cleaning, will attack and discolor rubber gloves.

21. CARE IN GARRISON AND CAMP.

a. Care and cleaning in garrison and camp include care of the machine gun necessary to preserve its appearance and condition during periods when no firing is being done. Machine guns in the hands of troops should be inspected daily for proper condition and cleanliness.

b. Bore.

(1) Remove the barrel.

(2) Assemble a cloth patch to a cleaning rod and insert the rod into the bore through the breech end. Run the patch back and forth several times through the entire length of the bore and chamber. Repeat with several patches until the patch comes out clean.

(3) Impregnate a patch with OIL, lubricating, preservative, light. Run the patch through the bore several times.

### GERMAN 7.9-MM DUAL PURPOSE MACHINE GUN MG34

c. **Wood and Metal Surfaces.** Use a small cleaning brush to clean screwheads and crevices. With a clean dry cloth, remove all moisture, perspiration, and dirt from metal surfaces, and then wipe with a cloth slightly oiled with OIL, lubricating, preservative, light. This protective oil film should be maintained at all times. To clean the outer wood surfaces, wipe with a cloth lightly oiled with OIL, lubricating, preservative, light. Then clean with a soft dry cloth.

d. After cleaning and protecting the machine gun as described above, place it in the gun rack. Muzzle covers, gun covers, plugs, and rack covers should not be used because they collect moisture and promote rusting. However, when the squad rooms are being swept, it is permissible to cover the gun racks in order to protect the machine gun from dust. As soon as the rooms have been swept, the rack covers must be removed.

### 22. CARE PREPARATORY TO FIRING.

a. Before firing, the following instructions should be carefully observed in order to assure proper functioning of the machine gun.

b. Disassemble the gun into its main groups (fig. 55).

c. Run clean patches through the bore and chamber to remove all dirt and oil.

d. Thoroughly clean all metal parts and lightly oil with OIL, lubricating, preservative, light.

**CAUTION:** Do not oil the bore and chamber before firing because dangerous pressures may develop.

e. Lubricate the following with a drop of oil from an oiler.

- (1) Ejector groove on bolt.
- (2) Plunger at rear of extractor.
- (3) Underside of firing pin catch on bolt.
- (4) Firing pin-locking nut at rear of bolt.
- (5) Crevices around feed piece.
- (6) Underside of the 3 belt feed pawls.
- (7) Safety lever.
- (8) Groove for cocking handle on receiver.

f. Lubricant should be applied lightly because oil has a tendency to collect dirt which may act as an abrasive on the operating parts.

g. After the machine gun groups have been cleaned and oiled as described above, assemble the gun and wipe all outer surfaces with a lightly oiled rag.

### 23. CARE ON THE RANGE AND IN THE FIELD.

a. The machine gun must be kept free from dirt and well lubricated to obtain proper efficiency during firing. The following instructions should be carefully observed.

### CARE AND PRESERVATION

#### b. Before Firing.

- (1) See that the bore is free from dust, dirt, mud, or snow.
- (2) See that the chamber is clean and free from oil.
- (3) Test the trigger mechanisms at SAFE and FIRE.
- (4) Work the bolt back and forth to see that it is clean and well oiled, and that it works freely.
- (5) Examine the belts and magazines to see that they are free from dirt and properly loaded. Discard defective belts and magazines.

c. **During Firing.** In general, it should not be necessary to disassemble the machine gun in the field for cleaning. However, if the mechanism becomes very dirty or functions sluggishly, disassemble the gun into its groups (fig. 55), and clean as instructed in paragraph 22.

### 24. CARE AFTER FIRING.

a. The weapon should be cleaned after each session of firing and not later than the evening of the day on which it was fired.

b. Immediately after firing or as soon as possible, remove the barrel and run several wet patches impregnated with CLEANER, rifle bore, through the bore. If CLEANER, rifle bore, is not available, use warm soapy water or warm water alone or in the absence of these, cold water. Remove the patch from the cleaning rod and attach a cleaning brush. Run the brush through the bore several times. Make certain the brush goes all the way through the bore before reversing the direction. Remove the brush and run several patches wet with clean water through the bore and chamber again. Follow this with dry patches until they come out clean and dry. Finally, run a patch impregnated with OIL, lubricating, preservative, light, through the bore and chamber.

c. After the bore and chamber have been cleaned, disassemble the gun (fig. 55). Clean all the metal parts with a clean dry rag, then wipe with a lightly oiled rag before assembling. After assembling, wipe the exterior surface with a rag lightly oiled with OIL, lubricating, preservative, light.

### 25. PREPARATION FOR STORAGE.

a. OIL, lubricating, preservative, light, is the most satisfactory oil for preserving the mechanism of machine guns. This oil is satisfactory for preserving the polished surfaces, bore, and chamber for from 2 to 6 weeks, depending on climatic and storage conditions. Machine guns in short term storage should be inspected every 5 days. If necessary, the preservative film should be renewed.

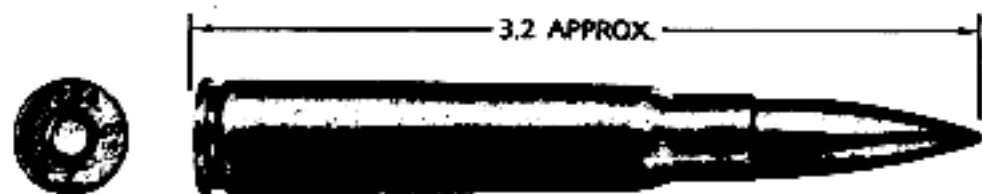
b. COMPOUND, rust-preventive, light, is satisfactory for preserving polished surfaces, bore, and chamber for a period of up to one year, depending on climatic and storage conditions.

**GERMAN 7.9-MM DUAL PURPOSE MACHINE GUN MG34**

c. Thoroughly clean all parts of the mechanism and the exterior of the weapon with SOLVENT, dry-cleaning. Dry with clean rags. After drying a metal part, do not touch with the bare hands. Then coat all metal parts with either OIL, lubricating, preservative, light, or COMPOUND, rust-preventive, light, depending on the probable length of storage. The bore is best coated with rust-preventive compound by dipping a cleaning brush in the compound and then running the brush through the bore two or three times. Then see that the bolt is fully home, and, handling the weapon by the butt and sling loop only, place it in the packing chest.

**Section VII  
AMMUNITION**

	Paragraph
General .....	26
Classification .....	27
Identification .....	28
Authorized cartridges .....	29
Tropical ammunition .....	30
Interchangeability of ammunition .....	31
Precautions in handling captured ammunition .....	32
Care, handling, and preservation .....	33
Field report of accidents .....	34



7.9-MM ARMOR-PIERCING CARTRIDGE (GERMAN)



CARTRIDGE, BALL, CAL. .30, M2 (U.S.)

RA PD 61187

**Figure 56 - Comparison of German 7.9-mm Armor-piercing Cartridge and Cal. .30 U.S. Ball Cartridge M2**

**(These Cartridges Can Not Be Used Interchangeably.)**

**AMMUNITION**

**26. GENERAL.**

a. The standard small-arms ammunition for use in German rifles, carbines, and machine guns is known as Patrone s.S. (Patr. s.S.). This is usually referred to as 7.9-mm caliber ammunition but is more accurately 7.92-mm caliber. The 7.9-mm German ammunition is similar in appearance to, but is not interchangeable with, U.S. cal. .30 ammunition, as shown in figure 56. As encountered in the field, 7.9-mm ammunition may be packed in cartons, in magazine clips, and in machine gun belts in ammunition carriers and boxes (figs. 57, 58, and 59). Cartridges primarily for use in machine guns are packed in cartons and loaded into machine gun belts (equipment with the weapon) in the field.

**27. CLASSIFICATION.**

a. **General.** Patrone s.S. (Patrone schweres Spitzgeschoss) is the standard 7.9-mm service cartridge, whereas Patrone l.S. (Patrone leichtes Spitzgeschoss) is reported to be reserved for practice firing against air targets.

b. **Service Ammunition.** The main types of 7.9-mm service ammunition are as follows:

Type	German Abbreviated Designation
Armor-piercing .....	Patr. S.m.K.
Armor-piercing-tracer .....	Patr. S.m.KL'spur
Armor-piercing-incendiary .....	Patr. P.m.K.
Ball .....	Patr. s.S.
Semi-armor-piercing .....	Patr. S.m.E.
Super-armor-piercing .....	Patr. S.m.K.H.

c. Practice ammunition may be classified as follows:

Type	German Abbreviated Designation
Ball .....	Patr. l.S.
Ball tracer .....	Patr. l.S.L'spur
Observation (or H.E. incendiary) .....	B-Patr.

**28. IDENTIFICATION.**

a. **General.** German small arms cartridges are identified primarily by markings on carton labels (fig. 60) and by appearance (fig. 56).

b. **Carton Labels.** In general, markings on carton labels do not indicate the caliber, except for nonstandard caliber sizes for purposes of distinction. The German 7.9-mm cartridges are indicated by "Patr." ("Patrone" or cartridge) followed by the type of cartridge, as indicated in paragraphs 27 and 29. For example, "Patr. S.m.K." indicates armor-piercing cartridges. No further markings on the carton label indicate 7.9-mm cartridges which are for use in rifles or machine guns. Additional markings may indicate the type of weapon

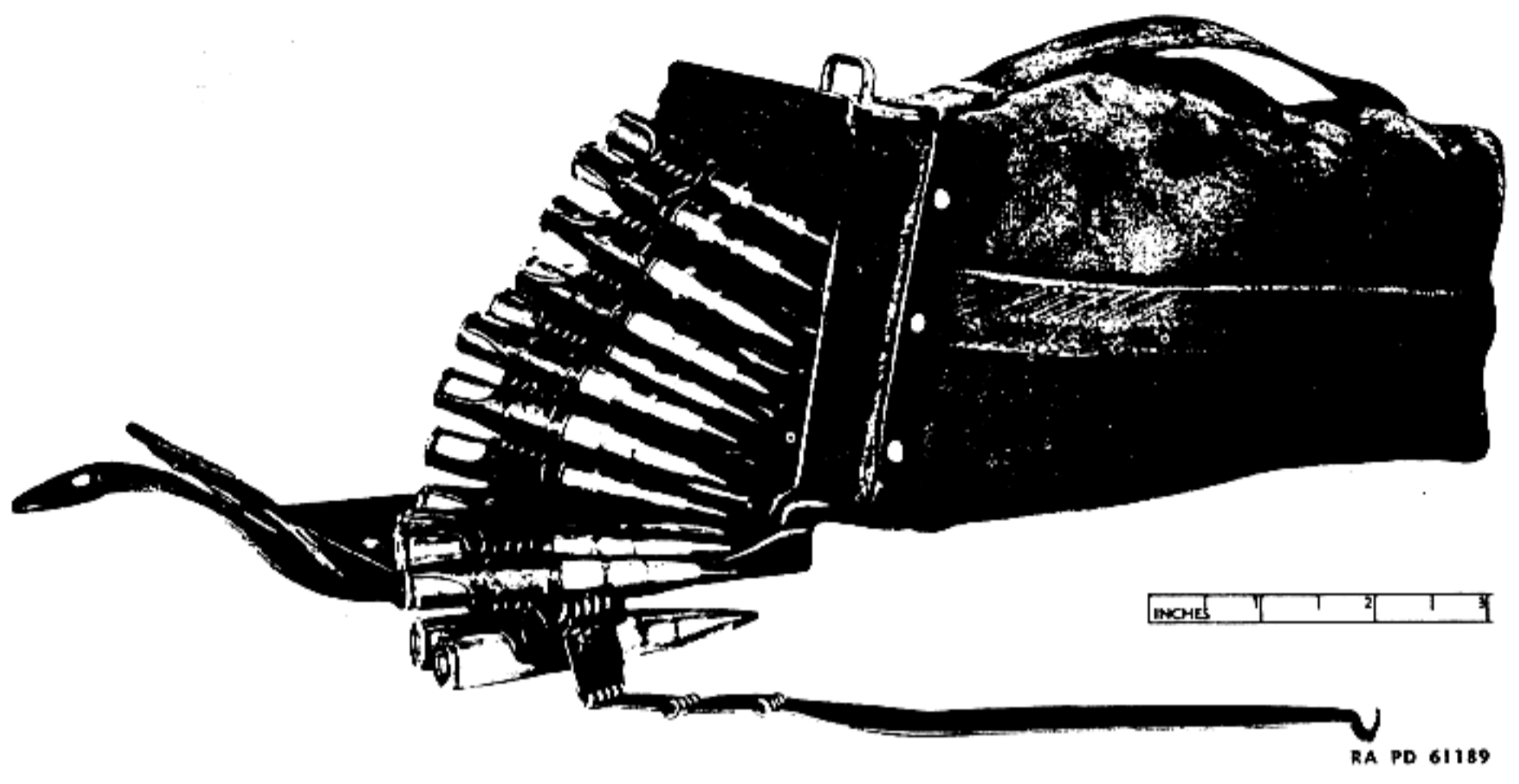


Figure 57 — Ammunition Carrier Showing Ammunition and Belt

54

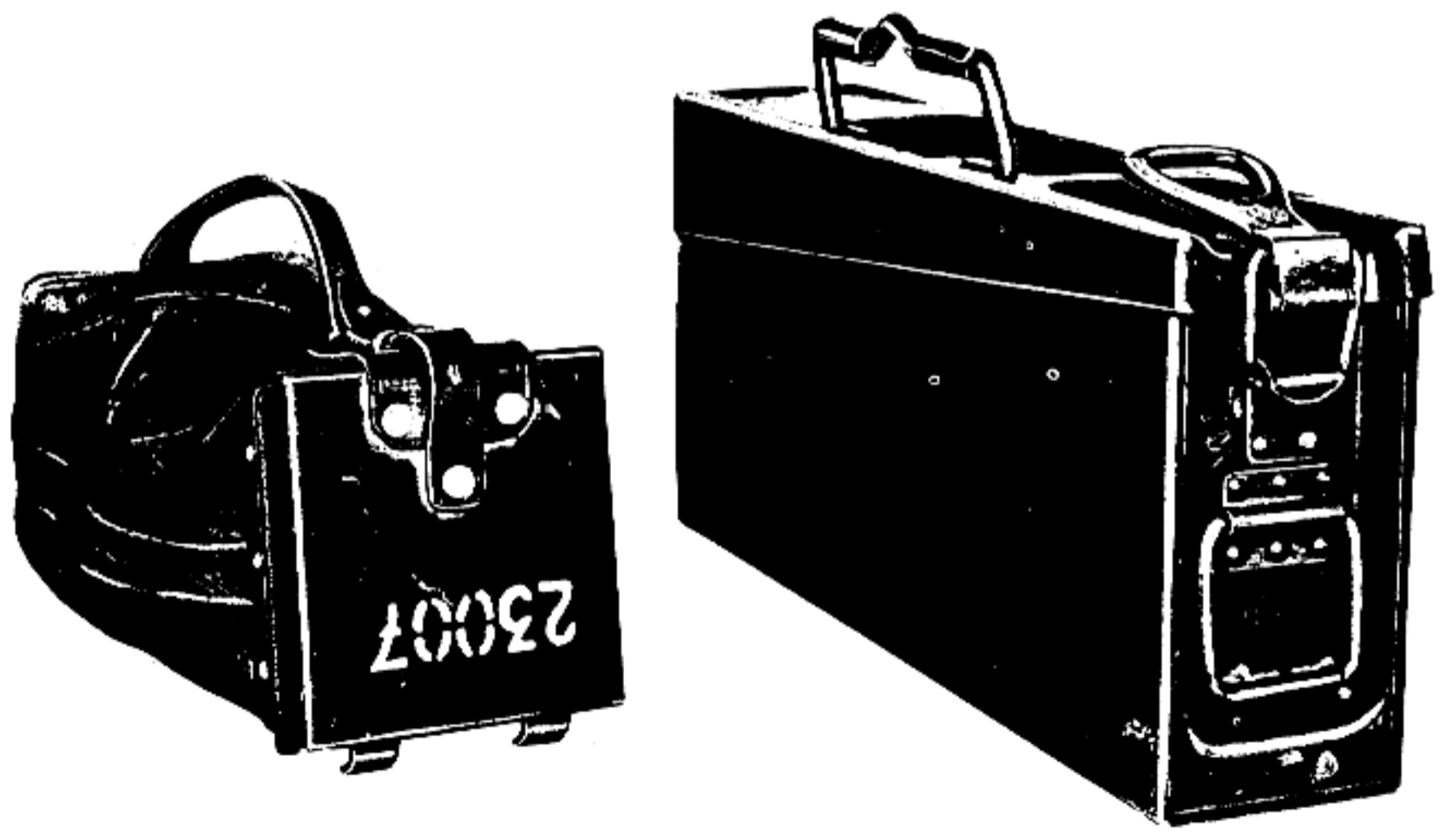


Figure 58 — Ammunition Carrier and Ammunition Box

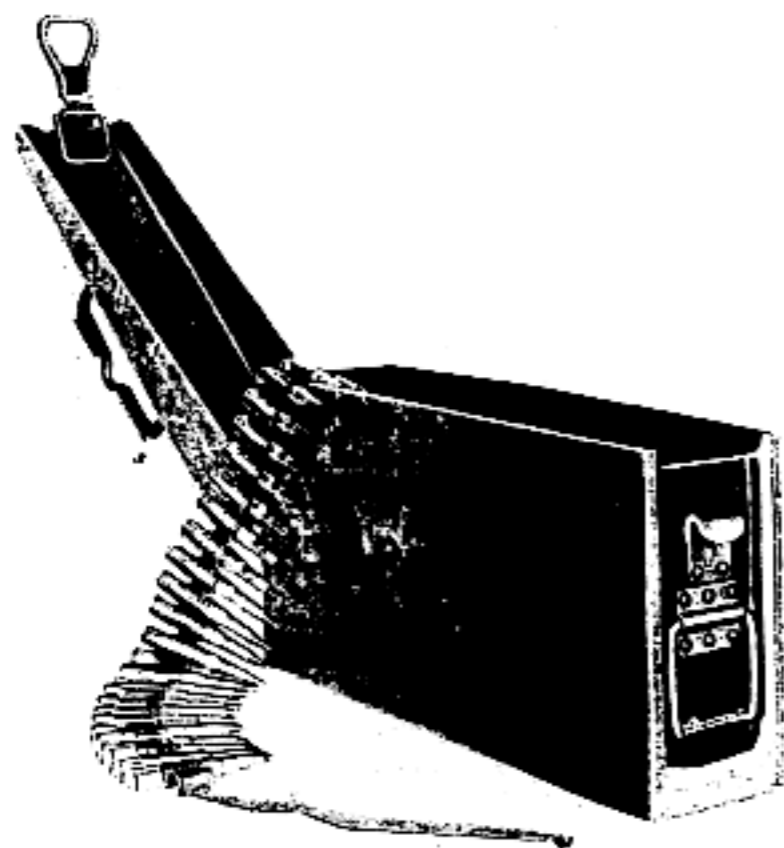
AMMUNITION

55

**GERMAN 7.9-MM DUAL PURPOSE MACHINE GUN MG34**

or packing, or the model of the weapon, as follows:

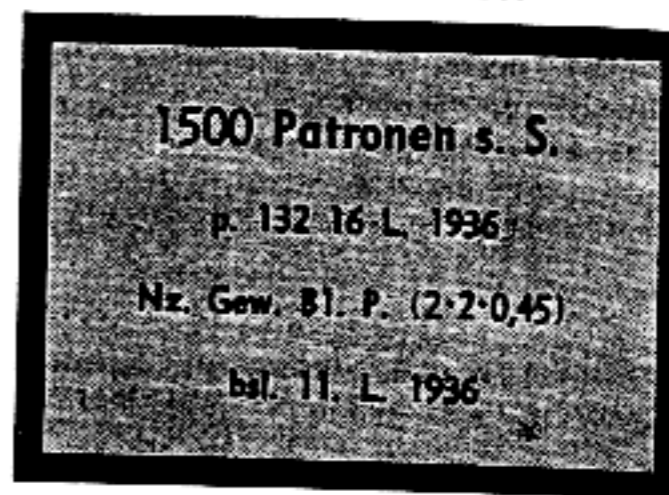
- "i.L." ..... Usually in red, indicates cartridges packed in clips. Issued for use in rifles, but may also be used in machine guns.
- "für Gew." or "nur für Gewehr" ..... Usually in red, indicates cartridges for use in rifles only.
- "für M.G." ..... Usually in red, indicates cartridges for use in machine guns.
- "Patr. 318" ..... Indicates cartridges only for antitank rifles (cartridge case is larger than that of the standard 7.9-mm ammunition described herein).
- "Pist. Patr. 08" ..... Indicates 8-mm pistol and submachine gun ammunition.



RA PD 61191

**Figure 59 – Ammunition Box Showing Ammunition and Belt**

**AMMUNITION**



**BOX LABEL**

*DIMENSIONS: 10.3 X 7.5 cms.*

Label color: White, with black border and printing.

1500 rounds Patronen schweres Spitzgeschoss.  
(1500 CARTRIDGES with heavy pointed bullets)

RA PD 61192

**Figure 60 – Label on Packing Containers of German 7.9-mm Cartridges**

c. Typical Carton Label Marking. Typical markings and their English equivalents are shown in Table I.

**TABLE I  
TYPICAL LABEL MARKING ON CARTONS OF  
GERMAN CARTRIDGES**

German Marking	English Equivalent
1500 Patronen S.m.K. L'spur (gelb)	1500 cartridges, A.P. tracer (yellow)
P. 69. 10L. 39.	Lot number, 10th delivery, 1939
Nz. Gew. Bl. P. (2. 2. 0,45)	Rifle powder, NC flaked (size of grains)
Rdf. 47. L. 1935	Place of manufacture, 47th delivery, 1935
Patrh: S* P. 69 13L. 39	Brass cartridge case, S*, lot No., 13th delivery 1939
Gesch: P. 69 13L. 39-Geschoss-teile: P. 69	Bullet: lot No., 13th delivery, 1939
Satz: P. 69-zdh. 88: D.W.M. 774a. L. 39	Composition (tracer): Lot No. Cap 88: ?? delivery, 1939
Trocken aufbewahren. Gegen Stoss u. Fall zu schutze.	Keep dry. Protect from blows.

NOTE: S\* indicates alloy of 72% copper and 28% zinc. "St" or "S" would indicate steel.

**GERMAN 7.9-MM DUAL PURPOSE MACHINE GUN MG34**

d. **Markings on Cartridges.** Cartridges removed from their packings may be identified by appearance and markings. Typical markings on the base (fig. 56) are listed in Table II. Identifying color markings indicating type of cartridge are listed in Table III. For marking to indicate tropical ammunition, see paragraph 30.

**TABLE II**

**TYPICAL MARKINGS ON BASE OF GERMAN CARTRIDGES**

German Marking	English Equivalent
P 249	Manufacturer's initial (Polte) and identification.
S*, S or St	S* (alloy of 72% copper and 28% zinc), S or St (steel)
46	Delivery, 46th
35	Year of manufacture, 1935

**TABLE III**

**COLOR MARKINGS INDICATING TYPE OF GERMAN CARTRIDGES**

Color of Primer Seat or Base Band	Color on Bullet	Type
Green base band	None	Light practice ball (Patr. LS.)
Green	None	Heavy ball (Patr. s.S.)
Red	None	Armor-piercing (Patr. S.m.K.)
Red	Black tip	Armor-piercing-tracer (Patr. S.m.K. L'spur)
Black or red or red base band	None	Armor-piercing-incendiary (Patr. P.m.K.)
Black	Chromium-plated tip or all black except tip	Observation (B-Patr.), HE-incendiary
{ Red annulus or Red primer	{ Black or None	{ Super-armor-piercing (Patr.S.m.K.H.)

**AMMUNITION**

**e. Abbreviations.**

**TABLE IV**

**GERMAN ABBREVIATIONS**

B.	Beobachtung	Observation
B.	Buchse	Shotgun, gun, rifle
Bd. G.	Brandgeschoss	Incendiary bullet
Beob.	Beobachtung	Observation
Bl. P.	Blattchenpulver	Flaked gunpowder
B-Patr.	Beobachtungsgeschoss	Observation cartridge
Ex. Patr.	Exerzierpatrone	Dummy cartridge
f.	für	For
Flb.	Flugbahn	Trajectory
für Gew.	für Gewehr	For rifle
für M.G.	für Maschinengewehr	For machine gun
G.	Geschütz	Gun
G.	Gewehr	Rifle
Gesch.	Geschoss	Projectile, bullet
Gew.	Gewehr	Rifle
H.	Gehartet	Hardened
i.L.	in Ladestreifen	In rifle clip
K.	Kern; Stahlkern	Core; steel core
Kal.	Kaliber	Caliber, gage
Karab.	Karabiner	Carbine
l.	leicht	Light
L.	Ladestreifen	Rifle clip
L.	Lieferung	Delivery
L.	Lieferungsnummer	Delivery number
l.M.G.	leichtes Maschinengewehr	Light machine gun
L'spur	Leuchtspur	Tracer
m.	mit	With
m.E.	mit Eisenkern	With iron core (or soft steel core)
M.G.	Maschinengewehr	Machine gun
Mun.	Munition	Ammunition
Nz.	Nitrozellulose	Nitrocellulose
P.	Phosphor	Phosphorus
Patr.	Patronenhülse	Cartridge case
Patr. I.S.	Patrone leichte Spitzgeschoss	Cartridge with light, pointed bullet
Patr. I.S.L'spur	Patrone leichte Spitzgeschoss mit Leuchtspur	Cartridge with light, pointed bullet with tracer
Patr. P.m.K.	Patrone Phosphor mit Stahlkern	Cartridge with phosphorus with steel core
Patr. S.m.E.	Patrone Spitzgeschoss mit Eisenkern	Cartridge with pointed bullet with iron core
Patr. S.m.K.	Patrone Spitzgeschoss mit Stahlkern	Cartridge with pointed bullet with steel core

**GERMAN 7.9-MM DUAL PURPOSE MACHINE GUN MG34**

Patr. S.m.K.H.	Patrone Spitzgeschoss mit Stahlkern Gehartet	Cartridge with pointed bullet with hardened steel core
Patr. S.m.K.L'spur	Patrone Spitzgeschoss mit Stahlkern und Leuchtspur	Cartridge with pointed bullet with steel core and tracer
Patr. s.S.	Patrone schwer Spitzgeschoss	Cartridge with heavy pointed bullet
Patr. T.	Patronentasche	Cartridge pouch
Ph.	Phosphor	Phosphorus
Pist. Patr.	Pistolen Patrone	Pistol cartridge
P.K.	Pulverkasten	Ammunition box
Pl. Patr.	Platzpatrone	Blank cartridge
Pr.	Phosphor	Phosphorus
Pr-Geschoss	Phosphorgeschoß	Phosphorus bullet
P.T.	Pulvertemperatur	Ammunition temperature
S.	Spitzgeschoss	Pointed bullet
S. or s.	schwer	Heavy
schw.	schwer	Heavy
S-Gesch.	Spitzgeschoss	Pointed bullet
S.m.K.	Spitzgeschoss mit Stahlkern	Pointed bullet with steel core
S.m.K.H.	Spitzgeschoss mit Stahlkern Gehartet	Pointed bullet with hardened steel core
S.m.K.L'spur	Spitzgeschoss mit Stahlkern und Leuchtspur	Pointed bullet with steel core and tracer
St.	Stahl	Steel
Tp.	Tropen	Tropics
Ub.	Ubung	Practice

**29. AUTHORIZED CARTRIDGES.**

a. The only cartridges which may be authorized for use in the German 7.9-mm Dual Purpose Machine Gun MG34 are listed in Table V. For precautions in handling captured ammunition, see paragraph 33. For other ammunition interchangeable with the German ammunition, see paragraph 31.

**TABLE V  
AUTHORIZED AMMUNITION FOR USE IN GERMAN 7.9-MM DUAL PURPOSE MACHINE GUN MG34<sup>1</sup>**

German Abbreviated Designation	Type Service Ammunition	Description
Patr. s.S.	Ball	Average instrumental velocity, 2,380 ft. per sec. Bullet core is of hard lead.

<sup>1</sup> Maximum range of machine gun, on antiaircraft tripod is 2,200 yards. Using the telescopic sight it is 3,800 yards.

**AMMUNITION**

German Abbreviated Designation	Type Service Ammunition—Cont'd	Description
—für M.G.	Ball	For machine guns only.
—i.L.	Ball	Packed in clips for use in rifles, but may be used in machine guns, if other types are not available.
Patr. S.m.K. <sup>2</sup>	Armor-piercing <sup>2</sup>	Bullet, which is longer than that of Patr. s.S., has steel core and lead jacket <sup>2</sup> .
Patr. S.m.K.H.	Super-armor-piercing.	Bullet is similar to that of Patr. S.m.K. except that bullet core is of tungsten carbide.
Patr. S.m.E.	Semi-armor-piercing	Bullet is similar to that of Patr. S.m.K. except that bullet core is of iron or soft steel.
Patr. S.m.K.L'spur	Armor-piercing-tracer	Germans indicate for use against aircraft only.
Patr. P.m.K.	Armor-piercing-incendiary	Germans indicate for use against aircraft only. Contains phosphorus.
<b>Practice Ammunition</b>		
Patr. I.S.	Ball	Similar to Patr. s.S. except that bullet core is of light metal. Has a short range.
Patr. I.S.L'spur	Ball-tracer	Similar to Patr. I.S., but has a tracer element.
B-Patr.	Observation or H.E. incendiary	Germans indicate that this is only used in peacetime for checking ranges. An observation bullet containing a smoke producer of phosphorus and percussion fuze.

**30. TROPICAL AMMUNITION.**

a. Small arms ammunition for use in the tropics is readily identified by the painted ring, 2 millimeters wide, at the junction of the bullet

<sup>2</sup> When fired from a rifle will penetrate 0.33-inch steel plate at 440 yards, and 0.39-inch steel plate at 110 yards.

**GERMAN 7.9-MM DUAL PURPOSE MACHINE GUN MG34**

and cartridge case. The color of the ring is the same as that used on the primer to indicate the type of cartridge.

b. Containers for tropical ammunition may have the following label printed in red on white:

Für Tropen  
Normale Pulvertemperatur  
+ 25° C.

c. Tropical ammunition has a reduced weight of propellant and gives normal performance at +25° C. (77° F.). The temperature taken as normal for standard ammunition is 10° C. (50° F.).

**31. INTERCHANGEABILITY OF AMMUNITION.**

a. The 7.9-mm German cartridges, Patr. s.S., Patr. I.S., and Patr. S.m.K. types and the British 7.92-mm Besa ammunition are interchangeable for use in the German 7.9-mm Dual Purpose Machine Gun MG34. CARTRIDGE, ball, 7.92-mm (Chinese), can be used with this gun. No U. S. ammunition is authorized.

**32. PRECAUTIONS IN HANDLING CAPTURED AMMUNITION.**

a. All captured ammunition should be examined by qualified personnel as soon as practicable. Loose ammunition may be dangerous and is rarely worth the trouble of collection.

- b. Ammunition may be dangerous because of:
- (1) Deliberate "booby traps" laid by the enemy.
  - (2) Having been subject to fire or shelling.
  - (3) Removal of safety devices from fuzes, etc. (either deliberate or accidental).
  - (4) Exposure rendering explosive elements supersensitive.
  - (5) Being "life-expired."

c. Ammunition known or suspected of being dangerous will not be moved or touched, but destroyed in accordance with TM 9-1900 (chapter 4).

d. Destroyed ammunition should be salvaged for brass parts. In addition, all enemy airtight containers should be returned to the base. This also applies to timber and wooden boxes for use as dunnage or for remaking ammunition boxes.

e. Personnel handling captured ammunition should keep in mind the fact that although two types of ammunition appear to have identical measurements, they are not necessarily interchangeable. Experiments to ascertain interchangeability are forbidden except by special authority.

f. No unauthorized modifications or experimentation will be carried out on any ammunition.

**INSPECTION**

**33. CARE, HANDLING, AND PRESERVATION.**

a. In addition to the precautions and care in handling given in TM 9-1900 for U. S. small arms ammunition, the following applies particularly to the German 7.9-mm ammunition.

b. The German 7.9-mm Dual Purpose Machine Gun MG34 is susceptible to malfunctioning should any foreign matter get into its mechanism. Therefore, the German ammunition must be kept clean, and in particular must be free from fine sand.

**34. FIELD REPORT OF ACCIDENTS.**

a. Any malfunctions of ammunition must be promptly reported by the ordnance officer under whose supervision the material is maintained or issued (sec. VII, AR 750-10).

**Section VIII**

**INSPECTION**

General .....	Paragraph
Machine gun as a unit.....	35
Barrel casing and barrel.....	36
Bolt and spring.....	37
Belts and magazines.....	38
Mounts .....	39
	40

**35. GENERAL.**

a. Inspect the machine gun at intervals for operation and functioning. In all such inspections, use dummy ammunition. The use of live ammunition is prohibited.

**36. MACHINE GUN AS A UNIT.**

a. Check the gun for general appearance, metal parts for scratches, rust, or wear, and the wood butt for cracks and nicks.

b. Note if the butt is firmly secured.

c. Retract the bolt and note any sluggish movement or binding. Remove the feed cover and feed block and see that the chamber is clear. Grasp the bolt handle in the retracted position and pull the trigger, allowing the bolt to go slowly forward on an empty chamber. Note any binding or sluggish movement.

d. Check the functioning of the belt feed pawls, using dummy rounds in a belt.

e. Retract the bolt and set the safety at SAFE and pull the trigger. The bolt should remain cocked.

f. Turn the safety to FIRE and pull the trigger. The bolt should move forward. Load a dummy round in the chamber and fire it. Retract the bolt and note any difficulty or failure to extract or eject.



**GERMAN 7.9-MM DUAL PURPOSE MACHINE GUN MG34**

**37. BARREL CASING AND BARREL.**

a. Note whether front sight is properly secured. Check whether the bipod catch springs at the front and rear of barrel casing are set or broken.

b. Note if recoil booster is properly secured to the casing. If loose, tighten (the threads are right-hand).

c. Remove the barrel, hold it up to the light, and inspect the chamber and bore for wear, pits, or bulges. To facilitate inspection, place a piece of white paper in the breech end of the barrel in order to reflect light into the bore; then rotate the barrel slowly so that the light follows the circumference of the bore. If the barrel has pits or bulges, it should be turned over to ordnance maintenance personnel.

**38. BOLT AND SPRING.**

a. Examine the bolt surface for rust, roughness, or foreign matter. Inspect all notches, edges, corners, and grooves for burrs and wear.

b. Inspect firing pin point for wear and deformation.

c. Inspect the extractor and ejector for deformation or breakage.

d. Check the driving spring for kinks, fracture, and lost tension.

**39. BELTS AND MAGAZINES.**

a. Belts. Examine the belts for deformation or torn links. Note whether the belts are clean and free from rust.

b. Belt Feed Drum Magazines. Examine the 50-round belt feed drum magazines for deformation and for malfunction of the slide and cover. Deformed magazines should be turned over to ordnance maintenance personnel.

c. Spring-operated Drum Magazines. Examine the 75-round spring-operated drum magazines for deformation of the sides and mouth. Test the functioning of the magazine springs. Magazines with defective springs or deformed mouths should be turned over to ordnance maintenance personnel.

**40. MOUNTS.**

a. Bipod. Examine the bipod for rigidity of connections. Check the functioning of the thumbscrew nut between the bipod legs.

b. Antiaircraft Tripod. Check the elevation adjustment of the tripod by means of the leg clamps and wing nuts. Check functioning of adjustable support at the top of the tripod. Test rigidity of connections with tripod in any firing position.

**c. Tripod Mount.**

(1) Examine the erected tripod mount for rigidity of connections in any given firing position. Check functioning of the elevation

**MAINTENANCE UNDER UNUSUAL CONDITIONS**

mechanism and elevation stops. Check functioning of the traversing mechanism and traverse stops.

(2) Push the cradle to the rear several times to simulate recoiling, and note whether this alternately elevates and depresses the cradle, step by step.

**Section IX**

**MAINTENANCE UNDER UNUSUAL CONDITIONS**

General .....	Paragraph
Care in arctic climates .....	41
Care in tropical climates .....	42
	43

**41. GENERAL.**

a. When operating under unusual conditions such as tropical or arctic climates, severe dust or sand conditions, and near salt water, the precautions listed below should be scrupulously observed.

**42. CARE IN ARCTIC CLIMATES.**

a. In temperatures below freezing, and particularly in arctic climates, it is essential that all moving parts be kept absolutely free from moisture. It has also been found that excess oil on the working parts may solidify to such an extent as to cause sluggish operation or even complete failure.

b. The machine gun should be disassembled and the chief components (fig. 55) cleaned with SOLVENT, dry-cleaning, before use in temperatures below zero F. The working surfaces of parts which show signs of wear may be lubricated by rubbing with a cloth that has been lightly oiled with OIL, lubricating, preservative, light, and wrung out. At temperatures above zero F, the machine gun may be oiled lightly after cleaning by wiping with a lightly oiled cloth, using OIL, lubricating, preservative, light.

c. The machine gun should be left exposed to the cold whenever possible because, upon bringing it into a warm room, moisture will condense on the cold metal and cause rusting. Immediately upon bringing indoors, the machine gun should be thoroughly oiled with OIL, lubricating, preservative, light. After the machine gun has reached room temperature, it should be wiped off to remove the condensed water vapor and oiled again.

d. If the machine gun has been fired, it should be thoroughly cleaned and oiled. The bore may be swabbed with an oiled patch and, when the weapon reaches room temperature, thoroughly cleaned and oiled as prescribed in paragraph 24.

e. Before firing, the machine gun should be cleaned and oil removed as prescribed in paragraph 22. The bore and chamber should be entirely free from oil before firing.

GERMAN 7.9-MM DUAL PURPOSE MACHINE GUN MG34

43. CARE IN TROPICAL CLIMATES.

a. Tropical Climates.

(1) In tropical climates where the temperature and humidity are high, or where salt air is present, and during rainy seasons, the machine gun should be thoroughly inspected at frequent intervals and kept lightly oiled when not in use. The gun should be disassembled at regular intervals to enable the drying and oiling of parts.

(2) Care should be taken to see that the unexposed parts and surfaces are kept clean and oiled.

(3) In hot climates, use OIL, lubricating, preservative, light.

b. Hot, Dry Climates.

(1) In hot, dry climates where sand and dust are apt to get into the mechanism and bore, the machine gun should be wiped clean daily, or more often, if necessary. The gun should be disassembled as far as necessary to facilitate thorough cleaning.

(2) Oiling and lubrication should be kept at a minimum, as oil collects dust which acts as an abrasive on the working parts and may foul the bore and chamber. OIL, lubricating, preservative, light, is best for lubrication where temperatures are high, and should be lightly applied only to the surfaces or working parts showing signs of wear.

(3) Perspiration from the hands is usually acid and causes rust. Metal parts should therefore be wiped dry frequently.

(4) During sand or dust storms the breech and muzzle should be kept covered. The dust cover underneath the ejection opening should always be kept closed when no firing is done.

Section X

GLOSSARY

General .....	Paragraph 44
Abbreviations, symbols, and terms .....	45

44. GENERAL.

a. The following abbreviations, symbols, and terms may be found on labels, communications, and literature pertaining to the German 7.9-mm Dual Purpose Machine Gun MG34.

45. ABBREVIATIONS, SYMBOLS, AND TERMS.

Abzug .....	Trigger
Abzugsperrre .....	Full automatic trigger
B (Beobachtung) .....	Observation
Bd. G (Brandgeschoss) .....	Incendiary bullet
Behälter .....	Container

GLOSSARY

Beob. (Beobachtung) .....	Observation
B-Patr. (Beobachtungsgeschoss Patrone) .....	Observation cartridge
Bodenstück .....	Base plate
Brandkerngeschoss .....	Incendiary bullet
D (Dauerfeuer) .....	Full automatic fire
Düse .....	Blast trap
Dreibein 34 .....	AA Tripod 34
Einfuhrstück .....	Short leading belt
E (Einzelfeuer) .....	Single fire
Eisen .....	Iron
Eisenkern .....	Iron or soft steel core
Ex. Patr. (Exerzierpatrone) .....	Dummy cartridge
F (Feuer) .....	Fire
Feder .....	Spring
Feuer dampfer .....	Flash hider
Fliegervisier .....	Antiaircraft sight
Gehäuse .....	Receiver
G (Gewehr) .....	Rifle
Gelb .....	Yellow
Gesch. (Geschoss) .....	Projectile, shell, bullet
Gew. (Gewehr) .....	Rifle
Griffstück .....	Grip stock
Gurt .....	Belt
Gurtfuller 34 .....	Belt filling machine 34
Gurttrommel 34 .....	Belt drum magazine 34
Hauptladung .....	Propellant
Hohentrieb .....	Elevating mechanism
Hülse .....	Cartridge case
K. (Kern; Stahlkern) .....	Core; steel core
Kal. (Kaliber) .....	Caliber, gage
Karab. (Karabiner) .....	Carbine
Kartusche .....	Cartridge
Kartuschhülse .....	Cartridge case
Kartuschkorb .....	Ammunition basket
Kern .....	Core
Kolben .....	Butt stock
Korn .....	Front sight
Kugel .....	Bullet
Kugelpatrone .....	Ball Cartridge
Kupfer .....	Copper
l. (leicht) .....	Light
LM.G. (leichtes Maschinengewehr) .....	Light machine gun
L'spur (Leuchtspur) .....	Tracer

GERMAN 7.9-MM DUAL PURPOSE MACHINE GUN MG34

Lafette 34	.....	Tripod mount 34
Lafettenaufsatzstück	.....	Tripod mount AA adapter
Lauf	.....	Barrel
Laufbehälter 34	.....	Barrel container 34
Leuchtpatrone	.....	Tracer cartridge
Leuchtsatz	.....	Tracer composition
Leuchtspurpatrone	.....	Tracer cartridge
Leuchtspurgeschoss	.....	Tracer bullet
Leuchtspurmunition	.....	Tracer ammunition
Mantel	.....	Barrel casing; jacket
Messing	.....	Brass
M.G. (Maschinengewehr)	.....	Machine gun
Mun. (Munition)	.....	Ammunition
P. (Phosphor)	.....	Phosphorus
Panzergeschoss	.....	Armor-piercing bullet
Patr. (Patronenhülse)	.....	Cartridge case
Patr. I.S. (Patrone leichte Spitzgeschoss)	.....	Cartridge with light, pointed bullet
Patr. I.S.L'spur (Patrone leichte Spitzgeschoss mit Leuchtspur)	.....	Cartridge with light, pointed bullet with tracer
Patr. T. (Patronentasche)	.....	Cartridge pouch
Patronengurt	.....	Cartridge belt
Patronenhülse	.....	Cartridge case
Patronentrommel 34	.....	Magazine 34
Patr. P.m.K. (Patrone Phosphor mit Stahlkern)	.....	Cartridge with phosphorus with steel core
Patr. S.m.E. (Patrone Spitzgeschoss mit Eisenkern)	.....	Cartridge with pointed bullet with iron core
Patr. S.m.K. (Patrone Spitzgeschoss mit Stahlkern)	.....	Cartridge with pointed bullet with steel core
Patr. S.m.K.H. (Patrone Spitzgeschoss mit Stahlkern Gehartet)	.....	Cartridge with pointed bullet with hardened steel core
Patr. S.m.K.L'spur (Patrone Spitzgeschoss mit Stahlkern und Leuchtspur)	.....	Cartridge with pointed bullet with steel core and tracer
Patr. S.S. (Patrone schwer Spitzgeschoss)	.....	Cartridge with heavy pointed bullet
Patr. T. (Patronentasche)	.....	Cartridge pouch
Ph. (Phosphor)	.....	Phosphorus

GLOSSARY

Pist. Patr. (Pistolen Patrone)	.....	Pistol cartridge
P.K. (Pulverkasten)	.....	Powder box
Pl. Patr. (Platzpatrone)	.....	Blank cartridge
Pr. (Phosphor)	.....	Phosphorus
Pr-Geschoss (Phosphorgeschoss)	.....	Phosphorus bullet
P.T. (Pulvertemperatur)	.....	Ammunition temperature
Puffer	.....	Buffer
Pulver	.....	Powder
Pulverkasten	.....	Powder box
Pulverladung	.....	Powder charge
Pulvertreibladung	.....	Propelling charge
Rauchloses Pulver	.....	Smokeless powder
Rauchschwaches Pulver	.....	Smokeless powder
Richtvorrichtung	.....	Laying mechanism
Rot	.....	Red
Rückstosverstärker	.....	Recoil booster
S (Sicherung, Sicher)	.....	Safety
S. (Spitzgeschoss)	.....	Pointed bullet
s. or S. (schwer)	.....	Heavy
S.M.G. (schweres maschinengewehr)	.....	Heavy machine gun
Schlagbolzen	.....	Firing pin
Schliessfeder	.....	Driving spring
Schutzdeckel	.....	Dust cover
Schw. (schwer)	.....	Heavy
Seitenhebel	.....	Traversing lever
S-Gesch. (Spitzgeschoss)	.....	Pointed bullet
S.m.K. (Spitzgeschoss mit Stahlkern)	.....	Pointed bullet with steel core
S.m.K.H. (Spitzgeschoss mit Stahlkern Gehartet)	.....	Pointed bullet with hardened steel core
S.m.K.L'spur (Spitzgeschoss mit Stahlkern und Leuchtspur)	.....	Pointed bullet with steel core and tracer
Spannschieber	.....	Cocking handle
Spitze	.....	Point
St. or S (Stahl)	.....	Steel
Stahlgeschoss	.....	Steel bullet
Stahlkern	.....	Steel core
Stahlkerngeschoss	.....	Steel-core bullet; armor-piercing bullet
Stahlmantel	.....	Steel jacket
Teile	.....	Components
Tiefenfeueiriurichtung	.....	Searching fire mechanism
Träger	.....	Carrier
Trägrriemen	.....	Sling
Treibladung	.....	Propelling charge

**GERMAN 7.9-MM DUAL PURPOSE MACHINE GUN MG34**

Trommelfuller 34	Magazine filling machine 34
Trommelhalter	Magazine holder
Versager	Misfire
Verschluss	Breech mechanism
Visier	Sight
Zieleurichtung	Sighting mechanism
Zuführer	Belt pawl
Zuführerdeckel	Feed cover
Zweibein	Bipod
Zwischenstück	Extension belt

**Section XI  
REFERENCES**

Standard nomenclature lists	Paragraph 46
Explanatory publications	47

**46. STANDARD NOMENCLATURE LISTS.**

**a. Maintenance.**

Cleaning, preserving, and lubricating materials; recoil fluids, special oils, and miscellaneous related items	SNL K-1
Soldering, brazing, and welding material, gases and related items	SNL K-2

Current Standard Nomenclature Lists are as tabulated here. An up-to-date list of SNL's is maintained as the "Ordnance Publications for Supply Index," now published in OFSB 1-1

**47. EXPLANATORY PUBLICATIONS.**

<b>a. Ammunition, general</b>	TM 9-1900
<b>b. Maintenance.</b>	
Chemical decontamination materials and equipment	TM 3-220
Cleaning, preserving, lubricating, and welding materials and similar items issued by the Ordnance Department	TM 9-850
Decontamination	TC 38, 1941
Defense against chemical attack	FM 21-40
Military chemistry and chemical agents	TM 3-215
<b>c. Miscellaneous.</b>	
Range regulations for firing ammunition for training and target practice	AR 750-10
Qualifications in arms and ammunition training allowances	AR 775-10

**INDEX**

<b>A</b>	Page No.	<b>Page No.</b>	
Abbreviations, symbols, and terms	59-60, 66-70	Changing barrels	35-36
Ammunition		Characteristics of dual purpose machine gun	4
authorized cartridges	60-61	Classification of ammunition	53
care and preservation	63	Cleaning machine gun received from storage	49
classification	53	Color markings on ammunition	58
interchangesability	62	<b>D</b>	
field report of accidents	63	Data on machine gun	4
identification	53-60	Disassembly of dual purpose machine gun	44-47
precautions in handling captured ammunition	62	<b>E</b>	
tropical ammunition	61-62	Elevation and traverse	26-31
Antiaircraft tripod, inspection	64	<b>F</b>	
Arctic climates, care of materiel in	65	Feed cover and feed block, disassembly	44
Assembly of dual purpose machine gun	47	Field report of ammunition accidents	63
Authorized cartridges	60-61	Firing the machine gun on bipod, antiaircraft tripod, or tripod mount attachment	24
Automatic fire	24, 26	on tripod mount	24-31
<b>B</b>		metric and English units	31
Barrel		Flash eliminator and blast trap, disassembly	47
inspection	64	<b>G</b>	
removal	46	Gun, machine, dual purpose, German, 7.9-mm, MG34	
Barrel casing		ammunition	52-63
disassembly	47	care and preservation	49-52
inspection	64	characteristics	4
Belt drum magazine, 50-round, falling	13	data	4
Belt feed drum magazine, inspection	64	disassembly and assembly	43-47
Belts and magazines, inspection	64	inspection	63-65
Bolt and cocking handle, disassembly	46	maintenance under unusual conditions	65-66
Bolt and spring, inspection	64	malfunctions and corrections	40-42
Bore, care and preservation	49	operation	10-36
Buffer housing, disassembly	46	sighting equipment	37-40
Butt stock, disassembly	44	<b>I</b>	
<b>C</b>		Identification of ammunition	
Care and preservation		abbreviation	59-60
ammunition	63	carton labels	53-56
care after firing	51	marking on cartridges	58
care in garrison and camp	49-50		
care on range and in the field	50-51		
care preparatory to firing	50		
cleaning machine gun received from storage	49		
preparation for storage	51-52		

## GERMAN 7.9-MM DUAL PURPOSE MACHINE GUN MG34

	Page No.	Page No.
<b>I—Cont'd</b>		
Inspection		
barrel casing and barrel.....	63	loading the machine gun... 15-23
belts and magazine.....	64	mounting the machine gun... 10-13
bolt and spring.....	64	unloading..... 32-34
machine gun as a unit.....	63	
mounts.....	64-65	<b>P</b>
Interchangeability of ammunition	62	Precautions in handling captured ammunition..... 62
<b>L</b>		
Loading the machine gun:		<b>S</b>
with 50-round belt drum maga- zine.....	21-23	Service ammunition..... 53
with 75-round spring-operated drum magazine.....	23	Single fire..... 24
with the belt.....	15-21	Spring-operated 75-round drum magazine filling..... 15
		inspection..... 64
<b>M</b>		
Maintenance under unusual con- ditions		<b>T</b>
care in arctic climates.....	65	Telescopic sight for 7.9-mm dual purpose machine gun MG34
care in tropical climates.....	66	operation
Malfunctions and corrections		direct fire..... 39-40
immediate action.....	40-41	indirect fire..... 40
malfunctions.....	41-42	Trigger housing, disassembly..... 47
Metal surfaces, care and preserva- tion.....	50	Tripod mount, inspection..... 64-65
Metric and English units.....	31	Tropical ammunition..... 61-62
Mounting machine gun:		Tropical climates, care of materiel in..... 66
on antiaircraft adapter of tripod mount.....	13	
on antiaircraft tripod.....	12	<b>U</b>
on bipod.....	10-12	Unloading the machine gun, re- moval
on tripod mount.....	12-13	belt..... 32
		50-round belt drum magazine.. 32
<b>O</b>		
Operation		75-round spring-operated drum magazine..... 34
changing barrel.....	35-36	
dismounting the machine gun..	13	<b>W</b>
filling the belts and magazine	13-15	Wood surfaces, care and preserva- tion..... 50
firing the machine gun.....	23-31	