

# Operating Instructions for Kahr MK Series



MK9, 9mm  
MK40, .40 S&W  
Pistols

**KAHR**<sup>®</sup>  
**ARMS**

## Warning!

Read and fully understand this manual  
before removing this firearm from its package.

This firearm, like many revolvers and autoloading pistols, is designed without any external manual safety or internal magazine disconnect.

THIS PISTOL WILL FIRE IF THE TRIGGER IS PULLED!

It should be considered loaded and ready to fire until the magazine has been removed and the chamber has been checked to verify that the firearm is unloaded.

Discharging firearms in poorly ventilated areas, cleaning firearms, or handling ammunition may result in exposure to lead or other substances known to the State of California to cause birth defects, reproductive harm, and other serious physical injury. Have adequate ventilation at all times. Wash hands thoroughly after exposure.

Be sure to read and fully understand all  
"Important Safety Instructions" shown in red type.

<u>Contents</u>	<u>Page</u>
General Instructions . . . . .	2
General Description . . . . .	3
Primary Features . . . . .	3
Technical Data . . . . .	4
Standard Equipment . . . . .	4
Parts Listing . . . . .	4
Parts Schematic . . . . .	5
How The Kahr Pistol Functions. . . . .	6
Safety Devices . . . . .	7
Sights & Sight Adjustment . . . . .	7
Loading & Firing . . . . .	8
Unloading . . . . .	9
Break-In Period . . . . .	9
Dismantling & Reassembly . . . . .	10
Magazine Disassembly, Maintenance & Reassembly . . . . .	12
Checking Safety Devices . . . . .	13
Cleaning & Lubrication . . . . .	14
Notes on Reliability. . . . .	14
Warranty & Liability Exclusions . . . . .	15
Service Assistance . . . . .	15
Shipping Firearms For Service. . . . .	16
Notes. . . . .	17-19
Warranty Statement. . . . .	Back Cover

## General Instructions

Always assume that the KAHR Pistol or any other firearm is loaded and capable of being discharged until you, the handler, have personally verified the fact. Until the magazine is removed and you have inspected the chamber and completed the unloading procedure as presented on page 9, the firearm must be considered loaded and capable of being fired. **Never transport a loaded firearm.**

To reduce the possibility of an unintentional discharge, do not place your finger on the trigger until the firearm is pointed at the target and you intend to fire. When handling, carrying or holstering the pistol be sure that the trigger cannot be snagged by a foreign object. This can discharge the pistol.

**If you don't want the firearm to fire, keep your finger off the trigger.**

When firing with a two hand grip, keep the thumb of the weak hand on the weak hand side of the firearm, never behind the slide.

Before using the KAHR Pistol, completely read and fully understand the operating instructions and safety information in this manual. If you have difficulty understanding anything in this manual, call **Kahr Technical Support at (508) 791-3919** or seek qualified instruction in the safe use of the KAHR Pistol and other handguns.

**The Kahr Pistol is covered by  
U.S. Patents: #5,359,799;  
#5,412,894; #5,415,075;  
#5,502,914; #5,678,340**

## Important Safety Information

### **Caution:**

Law enforcement, military personnel and certain individuals may choose, for self defense purposes, to disregard or override several of the following safety instructions. To assure safety under these special situations, proper initial combat oriented training with periodically scheduled retraining, which stresses safe tactical procedures, is strongly recommended.

### **Caution:**

Failure to observe safety instructions in this manual can result in property damage, personal injury or death.

### **Caution:**

Prior to loading and firing, carefully read and understand this instruction manual. It gives basic advice on the proper handling and functioning of the KAHR Pistol.

Any firearm, including the KAHR Pistol, is a dangerous device. All firearms must be safely stored to prevent access by unauthorized persons, especially children.

Always store ammunition separately from firearms.

This manual is applicable only to the KAHR Pistol with which it was included. All instructions, warnings and precautions are not applicable to any other make or model.

For all sales contracts with KAHR, the place of jurisdiction shall be Delaware, and Delaware State Law shall be applicable.

## **General Description**

The KAHR Pistol, with its all-steel design, incorporates the key features most desired in a personal defensive handgun:

- Low overall weight
- Extremely compact size
- Outstanding quality of materials and workmanship

The KAHR Pistol is a mechanically-locked, recoil operated pistol with a passive striker block and a trigger-cocking (D/A Only) action.

Each round is automatically loaded until the magazine is empty. The slide is then held open by the slide release lever.

## **Primary Features**

The KAHR Pistol trigger system allows the shooter to quickly bring the pistol into action by eliminating the need to operate any manual safeties. Once the target has been selected and identified, simply pulling the trigger fires the pistol.

The striker is automatically held under partial tension after each round and is fully secured by a passive striker block until the trigger is fully depressed.

The slide release lever and the magazine catch are easily operated with the shooting hand.

The KAHR Pistol frame is uniquely designed to position the shooting hand as close to the center line of the bore as possible. This provides the benefit of greater control and a perceived reduction in recoil.

The all-steel construction and sophisticated computerized manufacturing technology employed in the construction of the KAHR Pistol assure superior quality and reliability.

Technical specifications may be altered without notice.

---

## **Important Safety Information**

### **Caution:**

Your safety and the safety of your family and others depends on your safe and mature adoption, development and consistent employment of SAFE FIREARMS HANDLING PRACTICES. If you are unfamiliar with firearms, seek further advice through safe handling courses run by your local gun clubs, approved instructor, or similar qualified organizations.

### **Warning:**

It is possible that a live round may remain in the chamber when the magazine has been removed or inserted. Any round in the chamber will discharge upon pulling the trigger regardless of whether the magazine is inserted or removed. Therefore, never leave the pistol unattended, even if the magazine is removed and exercise extreme caution after removing the magazine.

## Technical Data

### Operation:

Locked breech, modified "Browning-type" recoil lug

### Safety Systems:

Trigger cocking (DA) only, passive striker block. No magazine disconnect or external manual safeties

### Ammunition:

9mm (9x19 Para) / .40 S&W

### Trigger Weight:

7 - 9 pounds

### Sights:

Drift-adjustable, white bar-dot combat sights. Tritium night sights optional

### Length O/A:

5.5"

### Barrel :

3.0", 1-10 RH twist, polygonal rifling / 9mm  
3.0", 1-16 RH twist, polygonal rifling / .40 S&W

### Height:

4.0"

### Weight - Unloaded:

Pistol: 22.0 oz.; Magazine 1.9 oz. / 9mm  
Pistol: 23.0 oz.; Magazine 1.9 oz. / .40 S&W

### Magazine Capacity:

6-Rd with flush mag., 7-Rd with extended mag. / 9mm  
5-Rd with flush mag., 6-Rd with extended mag. / .40 S&W

### Grips:

Wraparound, textured nylon

### Material:

Stainless steel

### Finish:

Matte stainless steel

## Standard Equipment

- Protective Polymer Case, Trigger Lock
- 2 Magazines: one flush baseplate & one grip extension baseplate

## Important Safety Information

You must personally verify that the chamber is empty before field-stripping the firearm for cleaning or any other reason. Never place your finger on or near the trigger when operating the slide.

### Warning:

If the KAHR Pistol or any other firearm is carelessly or improperly handled, the user could cause an unintentional discharge which could result in death, serious injury, and/or property damage.

## Parts List

### Key & Part Name

### Part #

1. Frame	M001
2. Barrel	M002
3. Slide	M003
4. Slide Back	M004
5. Recoil Spring Assembly	M005
6. Striker Block	M006
7. Striker Block Spring	M007
8. Trigger	M008
9. Trigger Spring	M009
10. Trigger Spacer	M010
11. Trigger Pivot Pin	M011
12. Trigger Bar	M012
13. Trigger Bar Spring	M013
14. Cocking Cam	M014
15. Cocking Cam Spring	M015
16. Magazine Catch Body	M016
17. Magazine Catch Spring	M017
18. Magazine Catch Lock Pin	M018
19. Striker	M019
20. Striker Spacer	M020
21. Striker Spring	M021
22. Striker Spring Guide	M022
23. Extractor	M023
24. Extractor Spring	M024
25. Extractor Pin - Front	M025
26. Extractor Pin - Back	M026
27. Slide Release Lever	M027
28. Slide Release Spring	M028
29. Slide Release Spring Screw	M029
30. Unibody Ejector	M030
31. Cocking Cam Pivot Pin	M031
32. Rear Sight	M032
33. Front Sight	M033
34. Magazine Tube (6-round)	M034
35. Magazine Spring (6-round)	M035
36. Magazine Base Lock (6-round)	M036
37. Magazine Base (6-round)	M037
38. Magazine Follower (6-round)	M038
39. Magazine Tube (7-round)	M039
40. Magazine Spring (7-round)	M040
41. Magazine Base Lock (7-round)	M041
42. Magazine Base (7-round)	M042
43. Magazine Follower (7-round)	M043
44. Grip Screw (4)	M044
45. Grips - Nylon (left & right)	M045

### Caution:

This KAHR product is classified by the Bureau of Alcohol, Tobacco and Firearms as a firearm or dangerous weapon. It is therefore, potentially lethal!

Read this entire instruction manual carefully. It is essential to follow the safety instructions for your safety and the safety of others.

# KAHR MK SERIES

## Micro-Compact Autoloading Pistol

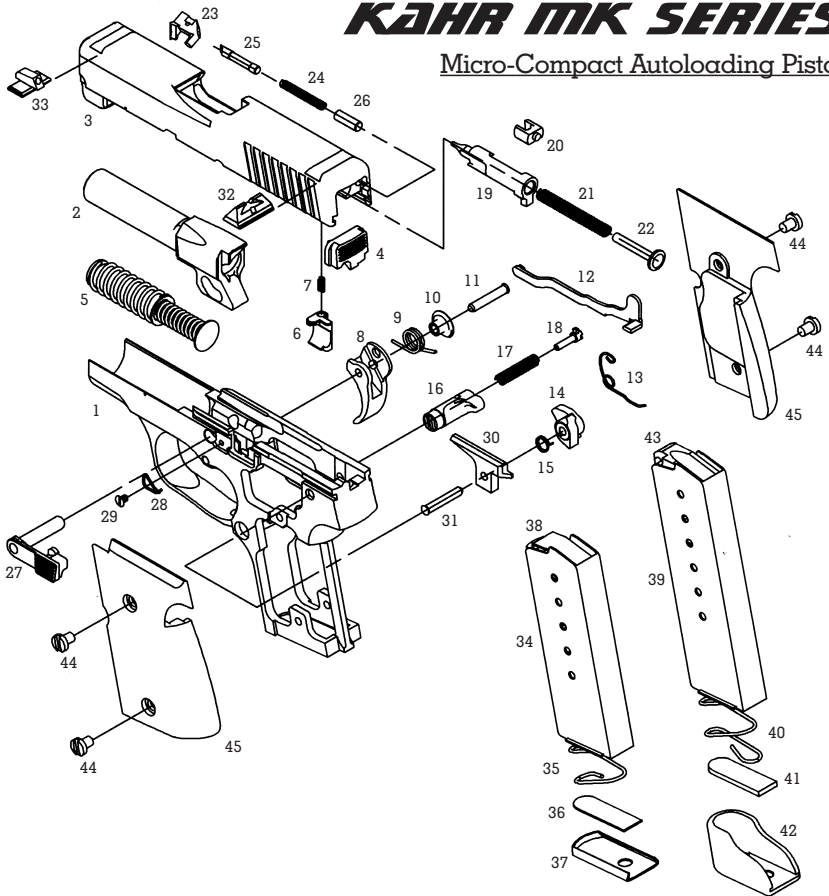

### Important Safety Information

#### **Warning:**

The KAHR Pistol has several design features and internal mechanical safeties designed to prevent unintentional discharges in the event that the pistol is dropped or receives a severe blow.

Like any mechanical device, when subjected to extreme forces not normally encountered in sporting, law enforcement, or military use, a part

failure can occur. Therefore, extra care and strict adherence to the safety instructions and other instructions contained in this manual is mandatory to minimize the risk of accidents.

#### **Caution:**

The proper and safe function of the KAHR Pistol cannot be assured if any parts have been altered or modified.

## How the Kahr Pistol Functions

FOR TESTING FUNCTION, ALWAYS USE AN UNLOADED PISTOL WITH AN EMPTY CHAMBER AND WITHOUT THE MAGAZINE INSERTED.

(described immediately below)

1. Without placing finger on the Trigger, remove the Magazine. Make sure that there is no round in the chamber by pulling the Slide fully to the rear and carefully checking that the chamber is empty. The pistol is now unloaded with the Magazine out.
2. Keeping finger off the Trigger, cock the pistol by pulling the Slide fully to its rearmost position and letting it run forward. The pistol is now partially cocked, i.e. the Striker Spring is partially tensioned. The Trigger is fully forward.

The following describes the functioning of the KAHR Pistol when it is loaded and fires:

As the Trigger is pulled (pressed to the rear), the internal passive Striker Block is released, i.e. a protrusion on the Cocking Cam lifts the Striker Block so that it no longer blocks the Striker from moving forward past the breech face to fire a chambered round. Simultaneously with this action, the Cocking Cam pulls the Striker back from half-cock to a fully cocked position under full spring tension. Completing the rearward pull of the

Trigger allows the Cocking Cam to release the Striker. With the Striker Block lifted, the Striker is free to move fully forward to contact and fire the cartridge.

The recoil impulse of the fired cartridge moves the Barrel and Slide backwards. After approximately 1/2 inch of movement to the rear, the camming action of the recoil lug of the Barrel and the pin on the Slide Release Lever in the Frame pulls the rear of the Barrel down to unlock it from the Slide. Unlocked, the Slide continues fully to the rear of its travel. During this rearward travel, the cartridge is pulled out of the chamber by the Extractor and is then thrown out to the right by the Ejector.

A ramp in the Slide rails disengages the Trigger Bar from the Cocking Cam. This allows the Cocking Cam to reset itself and reactivates the Striker Block.

The Recoil Spring begins to move the Slide forward toward its original locked position.

As the Slide moves forward:

1. a loaded round is pushed out of the magazine into the chamber;
2. the Striker is caught and put under partial tension by the Cocking Cam, and
3. the Barrel is pushed forward and upward, locking it with the Slide.

---

## Important Safety Information

### **Warning:**

The KAHR Pistol has no external, manual safety lever and no grip safety. It is fired like a double-action revolver by pressing the trigger. Always keep the firearm unloaded until you are ready to shoot. When the firearm is loaded do not touch the trigger unless you intend to fire!

### **Warning:**

If the KAHR Pistol appears to be operating improperly for any reason, danger of an unintentional discharge exists. The firearm must be immediately unloaded and not used until it is repaired. Make sure that the pistol is properly repaired and checked by KAHR ARMS or an authorized gunsmith before using it again.

## CAUTION: THE PISTOL WILL NOW FIRE IF THE TRIGGER IS PULLED.

After the last round has been fired and ejected, the Slide is held open by the Slide Release Lever.

NOTE REGARDING SLIDE RELEASE OPERATION: When the Slide is held open on an empty Magazine, the Slide Release Lever is very hard to depress. This warns the shooter that the Magazine is empty.

To easily release the Slide, either remove the empty Magazine or replace it with a loaded Magazine. Depressing the Slide Release Lever will then be much easier.

## Safety Devices

The Kahr Pistol has no conventional, externally-located safety lever. Therefore, the Trigger should only be touched when you intend to discharge the pistol.

### STRIKER BLOCK:

In the pre-tensioned position, a spring-loaded Striker Block projects into a recess in the Striker, preventing it from moving forward. The Striker Block is only released when the Trigger is fully to the rear.

## SAFETY FUNCTION OF THE COCKING CAM DESIGN AND POSITION:

The forward movement of the Striker is blocked by the Cocking Cam. Due to the design and positioning of the Cocking Cam, there is no way for the Striker to move forward past the Cocking Cam under normal use unless the Trigger is pulled.

## Sights & Sight Adjustment

These consist of a Rear Sight which has a white bar insert under the sighting notch and a Front Sight which has a white dot insert.

### Windage adjustments are normally made with the Rear Sight Only.

Both the Front and Rear Sights are held in place by the tight fit of the Sight to the dovetail. Windage (side to side) adjustments are made by pressing the Rear Sight in the direction that you want the bullet placement to move. For example, if the pistol groups to the left of your aiming point, move the Rear Sight to the right. This will move the bullet placement to the right.

Note: Sight adjustments should be made with a sight adjustment tool that is designed to move the Sight without damaging the Slide, dovetail cut or the Sight itself. When pressing the Sights to make an adjustment, use a non-marring material against the Sight and the Slide to avoid damage.

---

## Important Safety Information

### Safety Rules:

1. Always handle any firearm as if it were loaded to avoid unintended discharges.
2. Never point any firearm at anything you do not intend to shoot.
3. Never take anyone's word that any firearm is unloaded. Check for yourself, with fingers off the trigger, and the firearm pointed in a safe direction.

4. Always be sure barrel and action are clear of obstructions. First remove the magazine and unload the pistol, then clear obstructions immediately so that the firearm will function correctly and safely.
5. Never squeeze the trigger or put your finger in the trigger guard until you are aiming at the target you intend to shoot.

## Loading & Firing

WHEN LOADING THE KAHR PISTOL, ALWAYS BE SURE THAT THE PISTOL IS POINTED IN A SAFE DIRECTION AND THAT THE TRIGGER FINGER IS OUTSIDE OF THE TRIGGER GUARD AND WELL AWAY FROM THE TRIGGER.

USE ONLY AMMUNITION OF THE PROPER CALIBER AS SPECIFIED ON THE FIREARM.

The Magazine is filled by pushing individual rounds, base first, into the front of the Magazine. First press the round down to overcome the pressure of the Magazine Spring, then push the partially inserted round fully to the rear.

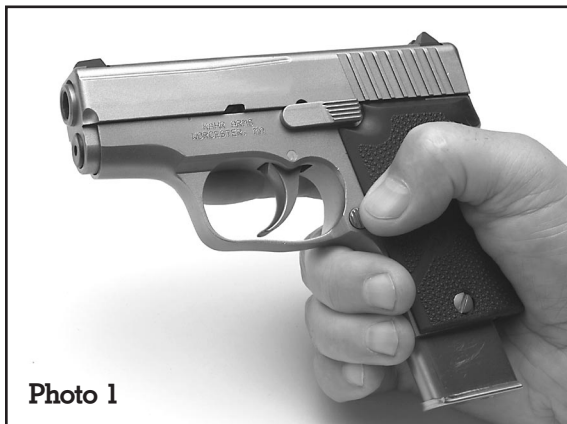

Photo 1

Note: be sure that all rounds are pressed fully to the back of the Magazine.

Insert the Magazine into the magazine well at the base of the Grip until the Magazine Catch engages fully.

Pull the Slide fully to the rear and allow it to spring forward into the locked position. Do not impede the forward travel of the Slide or attempt to ease the Slide forward. The full spring tension of the Recoil Spring is required to assure proper feeding of the round from the Magazine.

The trigger finger must remain outside the trigger guard until the target has been identified and you intend to shoot.

Note: Do not load an individual round into the chamber and then close the Slide. This can damage the Extractor. Only chamber rounds from the Magazine as described above.

The KAHR Pistol is now ready to fire.

**IF YOU PULL THE TRIGGER, THE PISTOL WILL FIRE.**

After the last round has been fired, the Slide will remain open.

## Important Safety Information

6. Never store a loaded firearm. Unload the KAHR Pistol as described on page 9. After verifying that the firearm is empty and magazine out, point the firearm in a safe direction and pull the trigger. Store the KAHR Pistol in this condition only.

7. Never shoot at a hard surface, such as a rock, or a liquid surface, such as water. A bullet may ricochet and travel in any direction to strike you or an object that you cannot see.

8. Always be sure your backstop is adequate to stop and contain bullets before shooting so that you do not hit anything outside the range area.



Remove the empty Magazine by pushing the Magazine Catch on the front of the left Grip (see photo #1) and pulling the Magazine from the magazine well. Insert a full Magazine and then push the Slide Release Lever downward, The KAHR Pistol is again ready to fire.

## Unloading

**WHEN UNLOADING THE KAHR PISTOL, ALWAYS BE SURE THAT THE PISTOL IS POINTED IN A SAFE DIRECTION AND THAT THE TRIGGER FINGER IS OUTSIDE OF THE TRIGGER GUARD AND WELL AWAY FROM THE TRIGGER.**



Remove the Magazine by depressing the Magazine Catch on the front of the left Grip (see photo #1) and pulling the Magazine from the magazine well. Pull the Slide fully to the rear (see photo #2) to eject the round which may be in the chamber. Visually check to ensure that no round remains in the chamber.

Allow the Slide to spring forward by releasing it.

After making absolutely sure that the Magazine is removed and the chamber is empty, point the pistol in a safe direction and pull the Trigger to release tension on the Striker.

**CAUTION:**  
**ALWAYS UNLOAD YOUR KAHR PISTOL IMMEDIATELY AFTER USE AND PRIOR TO CLEANING AND STORAGE TO MINIMIZE THE RISK OF UNINTENTIONAL DISCHARGE.**

## Break-In Period

The KAHR Pistol must run through an initial break-in period before achieving fully reliable feeding and functioning. The pistol should not be considered fully reliable until after it has fired 200 rounds.

## Important Safety Information

9. Always be sure of your target and the area behind it before you shoot. A bullet can travel through or past your target up to 1 mile. If in doubt, do not shoot.

10. Always put a responsible and competent person in charge to maintain safety and discipline when a group is firing on a range to reduce the likelihood of accidents.

11. Always carry a firearm empty and open while at a public, or private range, until you are ready to fire. Keep it pointed towards the backstop during loading, firing, and unloading.

12. Never leave a firearm unattended. Anyone, especially a child, may fire it.

## Dismantling & Reassembly

BEFORE DISMANTLING OR CLEANING THE KAHR PISTOL, BE ABSOLUTELY SURE THE PISTOL IS UNLOADED (Follow the unloading instructions on page 9).

For normal cleaning, the KAHR Pistol should only be dismantled into its main components:

- Slide
- Barrel
- Recoil Spring Assembly
- Frame
- Magazine

**DO NOT DISMANTLE THE PISTOL FURTHER THAN THE MAIN COMPONENTS DESCRIBED ABOVE (except Magazine),** To do so may create an unsafe condition and affect the pistol's Warranty.

For maintaining and cleaning the KAHR Pistol, use only high quality, commercial-ly available cleaning equipment, solvents and lubricants.

### Dismantling

The KAHR Pistol is dismantled to its main components in the following steps:

1. Remove the Magazine and visually check to be sure that the chamber is empty by pulling back the Slide. (see photo #1 and #2)

2. Draw the Slide back about 1/2 inch so that the small witness marks on the Slide and Frame align (see circled area in photo #3) and internal projection on the Slide Release Lever can be seen through the rear semi-circular relief cut in side of the Slide (see photo #3).

3. Push the pin of the Slide Release Lever out of the pistol from right to left. (Use a light, non-marring hammer or plastic screwdriver handle if necessary).

4. Ease the Slide forward under Recoil Spring tension.

5. With the Slide Release Lever removed, pull the Trigger to release the Striker, then relax pressure on the Trigger and push the Slide forward off of the Frame.

6. Removal of the Barrel (see photos #4 & #5) is carried out as follows: Push the rear of the Recoil Spring Assembly slightly forward with the thumb and lift it clear of the recoil lug.

**Photo 3**



## Important Safety Information

13. Never use a firearm that fails to function properly and never force a jammed action, as the jammed round may discharge.

14. Always transport the KAHR Pistol unloaded with the trigger unextended (See page 9) in a locked case.

15. Failure to fire:

Keep the firearm pointed toward the target and wait 30 seconds after it fails to fire. If a hangfire (slow ignition) has occurred, the round should fire within 30 seconds. If it does not fire, remove the magazine, eject the round and check for an obstruction. Then, examine the primer. If the firing pin indent on the primer is light or nonexistent, have the firearm examined by a competent gun-

**CAUTION: PROTECT EYES WHEN REMOVING THE RECOIL SPRING ASSEMBLY. THE ASSEMBLY MAY BE UNDER TENSION AND MAY POP OUT OF POSITION AND CAUSE INJURY!**

7. Carefully remove the Recoil Spring Assembly (see photo #4).

**NOTE: DO NOT ATTEMPT TO DISMANTLE THE RECOIL SPRING ASSEMBLY. THIS IS A FACTORY ASSEMBLED COMPONENT. THE ASSEMBLY IS UNDER TENSION AND MAY POP OUT OF POSITION AND CAUSE INJURY!**

8. Grasp the recoil lug of the Barrel and push it slightly forward, then lift and pull it rearward out of the Slide (see photo #5).

#### Reassembly

First, assemble the Slide components reversing the order in which they were dismantled. Then, before installing the Slide onto the Frame, do the following:

Make sure that the Recoil Spring Assembly is parallel to the Slide rails and not off to one side. Note: Be sure that the large flat disc at the rear of the Recoil Spring Assembly is positioned in the circular cut in the front of the Barrel's recoil lug.

Next, without depressing the Trigger, move the assembled Slide just far enough onto the Frame to partially insert the pin of the Slide Release Lever

through both the Frame and the slot in the Barrel's recoil lug.

**Note: Carefully press down on the front of the Ejector as the Slide Back passes over it to avoid interference as the Slide moves onto the Frame.** Then, pull the Slide rearward to line up the small witness marks on the Slide and Frame (see circled area in photo #3). Finally, push the Slide Release Lever in until it clicks into position. If problems occur during assembly, remove the Slide and recheck the instructions above.

**If the Slide will not go smoothly onto the Frame, do not force it as this could cause damage and may void the Warranty.**

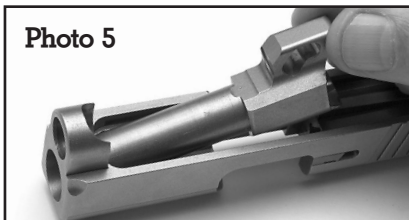
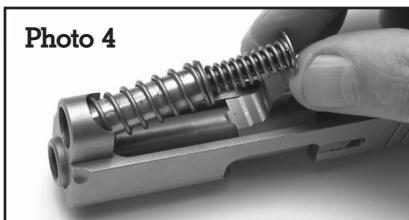

### **Important Safety Information**

smith. If the firing pin indent on the primer appears normal (like similar previously fired rounds) the ammunition may be at fault. Segregate any misfired rounds from other live ammunition and empty cases, and continue firing.

**Note:** Dispose of misfired rounds in accordance with ammunition manufacturer's instructions.

16. Never discharge a firearm near an animal unless it is trained to accept the noise. A startled animal could injure itself or cause an accident.

17. Never walk, climb, follow a companion or hunt with your pistol in your hand and ready to fire (in battery).

## Magazine Disassembly, Maintenance & Reassembly

### Disassembly

Ensure that the Magazine is unloaded. Insert a 1/8" or smaller pin (or length of stiff wire, etc.) through the bottom sight holes in the Magazine Tube (A), between coils of the Magazine Spring (D). This will contain most of the spring tension during disassembly. Using a small punch (or ball-point pen or similar expedient), depress the locking stud of the Magazine Base Lock (B) through the hole in the bottom of the Magazine Base (C) (see photo #6).

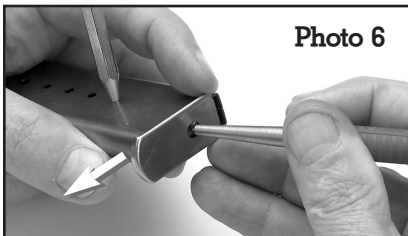

Push the Magazine Base forward off the Magazine Tube. The pin previously inserted in the bottom sight holes of the Magazine Tube now contains the Magazine Spring under some compression. Point the bottom of the Magazine Tube in a safe direction, contain the Spring's free end protruding from the bottom with your thumb, and carefully withdraw the pin from the Magazine sight holes.

**CAUTION! THE MAGAZINE SPRING IS UNDER PRESSURE.** Be sure to contain the Spring when withdrawing the pin to prevent damage and/or injury.

Remove the Magazine Spring and Magazine Follower (E) through the bottom of the Magazine Tube.

The Magazine is now completely disassembled (see photo #7). Clean all parts thoroughly with solvent. Wipe all parts lightly with lubricant-moistened cloth before reassembly.

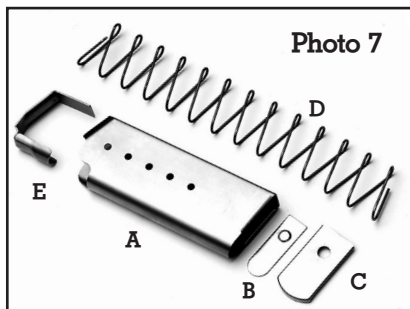

**CAUTION! DO NOT OVER LUBRICATE.** Lubricant can penetrate the primer of ammunition and render it inoperative causing a failure to fire.

Inspect the Magazine Base and Magazine Base Lock for cracks. Inspect the Magazine Tube for cracks or voids in the seam weld area. Inspect Magazine Follower for chips and cracks. Check the

### Important Safety Information

18. When preparing to fire, be sure that the area behind the slide is free of obstructions (watch your thumb) as the slide will move back sharply upon firing.

19. Never drink alcoholic beverages or take drugs before or during shooting as your vision and judgment can be seriously impaired, making your gun handling unsafe.

20. Always seek a doctor's advice if you are taking medication to be sure you are fit to shoot and handle a firearm safely.

21. Always wear ear protection when shooting, especially on a range. Without ear protection, the noise of firing can lead to cumulative long-term and permanent hearing loss.

metal follower pin in the Magazine Follower for correct depth and tightness of fit (on the 7-round extended grip Magazine, only). Ensure that the Magazine Follower moves freely inside the Magazine Tube. Replace components as required.

Check the Magazine feed lips for distortion, burrs or nicks, and especially for smoothness at the magazine catch slot. Replace any Magazine components as needed.

**Note:** Magazines should always be handled with care. If a Magazine becomes damaged as a result of being dropped on a hard surface, it should be replaced. Do not attempt to repair it.

#### Reassembly

After cleaning, inspection and lubrication, reassemble the Magazine in reverse order from disassembly, again using a pin or wire through the lowest sight holes to contain the Magazine Spring for ease of fitting the Magazine Base Lock and Magazine Base.

Ensure the empty, reassembled Magazine seats fully when inserted in the pistol, and ejects freely from its well when the Magazine Catch is depressed.

### Checking Safety Devices

The following safety check is to be carried out at regular intervals and before the pistol is used:

#### Important Safety Information

22. Always wear protective shooting glasses for eye protection. Do not hold an autoloading pistol near your eye or face as the slide will move back sharply upon firing.

23. Always make sure that any firearm is unloaded before cleaning, storing or transporting. When handing the KÄHR Pistol to another person, be sure that the slide is locked open with the magazine removed.

With the Slide removed and the Barrel dismantled, the Striker is drawn back manually about 1/4 inch and then eased forward again. The tip of the Striker must not project beyond the breech face of the Slide.

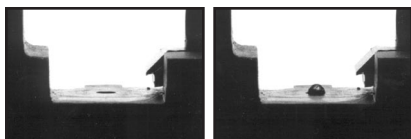

**Correct**

**Wrong!**

**Note:** When easing the Striker forward, be careful not to depress the Striker Block which sits next to the Striker. If it is depressed during the safety check, it will allow the Striker to project beyond the breech face.

#### Note Regarding Primer Indent and Distorted Spent Cases

Upon examining fired cases, you may notice that the primer indent appears distorted or elongated. This is normal for the striker system design of the KÄHR pistols. You may also notice that the spent case becomes slightly deformed into the shape of a "D" instead of an "O" shape. This is considered normal for the KÄHR pistol and is caused by the spent case touching the bottom of the ejection port when exiting the gun. Neither of these two situations are a cause for concern and it is not necessary to contact the service department.



24. Always keep clear and keep others clear of the ejection port, as spent cartridges are ejected with enough force to cause injury.

25. Never place fingers in the ejection port; they could be injured by the slide moving forward unintentionally.

26. Never place fingers on a hot slide or barrel during or after firing, as they could be burned by the hot metal.

## Cleaning & Lubrication

Before the initial shooting of the new Kahr Pistol, the pistol should be disassembled following the instructions in this manual and cleaned with a commercial gun cleaning solvent. After each shooting session, the cleaning process should be repeated to remove firing residue from the inside and outside of the Barrel, Slide, Frame and Magazine.

Once cleaned, all parts should be lightly lubricated with a commercial gun lubricant. Follow solvent and lubricant manufacturer's instructions.

The handgun should be kept clean and properly lubricated at all times. Lubricants can evaporate over time. Therefore, lightly lubricate the handgun once a month whether or not it has been fired. Be sure your handgun is FULLY UNLOADED (Magazine removed and chamber empty) before performing any cleaning or maintenance.

### Note Regarding Lead Bullets:

Lead (unjacketed) bullets can cause excessive bore fouling. Extra attention to cleaning the bore is recommended after firing lead bullets.

---

## Important Safety Information

27. Only use high-quality commercially manufactured ammunition, in excellent condition and in the correct caliber for your pistol.

The use of reloaded ammunition will void the Warranty because reloads or poor quality ammunition may not meet industry specifications (SAAMI and/or NATO), may exceed pressure limits and could be unsafe.

## Notes on Reliability

If this firearm is to be used in lawful self-defense, the user must understand that overall reliability is based upon the interaction of four factors: handgun, magazine, ammunition and user.

A handgun is only a mechanical device. It can fail to function properly despite the use of the finest materials and the greatest possible care in its design and manufacture. To ensure the highest level of reliability, we suggest that you adhere to the following guidelines:

1. Obtain the guidance of a qualified or accredited firearms instructor before using the handgun.
2. Use only the highest quality factory ammunition. Avoid reloads, surplus and budget priced ammunition as well as any ammunition designed by its manufacturer for use in carbines or other shoulder-fired firearms. At times, a particular model of handgun will not reliably function with a specific brand or loading of ammunition. Selected ammunition should be test fired (100 rounds minimum) to ensure reliability. Also, ammunition manufacturers can make changes to their ammunition.

28. Do not shoot the Kahr Pistol near any part of your body as the slide will move back sharply upon firing.

29. Always unload the firearm immediately after firing.

30. Do not allow anyone to handle or attempt firing the Kahr Pistol until they have read this manual.

tion such as substituting a different powder or primer. Consequently, ammunition which proved reliable in the past may suddenly begin to cause malfunctions. Inspect all ammunition for visible defects before loading it into the Magazine.

3. Use only KAHR ARMS manufactured Magazines. Consider purchasing extra Magazines so that they may periodically be rotated, allowing the Magazine Spring to relax. When inserting a Magazine into the handgun, listen for it to click into place, then pull down on the Magazine Base to make sure that it is seated and locked.

4. Improper shooting technique and grip can cause a variety of malfunctions such as a failure to properly eject or feed. Also, some loadings of ammunition are more sensitive to improper shooting technique or grip than others. Maintain a firm but comfortable grip on the handgun. The shooting arm should supply resistance to the handgun rather than serving as a shock absorber.

## **Warranty & Liability Exclusions**

Notwithstanding the provisions contained in any other printed Warranty statement(s) made by KAHR ARMS or by one of KAHR ARMS' affiliates, the following exclusions from Warranty, among others, shall apply:

1. If the pistol is dismantled by the purchaser or by third parties further than described in this manual, and if, as a result of inappropriate handling or incomplete reassembly, damage or malfunctions are

caused, as a result of which the safety devices are rendered ineffective, then the purchaser shall forfeit any claim to guarantee against damages thereby incurred to persons or property.

2. Any change to the basic construction of the weapon, in particular by the circumvention of the safety devices, is strictly prohibited for safety reasons, and precludes the use of the weapon.

## **Service Assistance**

Should service be required, call the KAHR ARMS Customer Service Dept. at (508) 795-3919 or Fax: (508) 795-7046, giving full details of the problem you have experienced, date of purchase and dealer from whom the pistol was purchased.

If KAHR ARMS Customer Service recommends that the pistol be returned to the factory for service, you will receive a factory "Return Authorization" Number. Ship the unloaded pistol, prepaid via UPS or FEDEX, with a copy of the sales receipt and "Return Authorization" Number to:

K.A.I.  
130 Goddard Memorial Dr.  
Worcester, MA 01603  
Attn. Customer Service Dept.,  
Phone: (508) 795-3919  
Fax: (508) 795-7046  
Web Address: [www.kahr.com](http://www.kahr.com)  
[www.kahrshop.com](http://www.kahrshop.com)  
E-mail: [kahrcls1@aol.com](mailto:kahrcls1@aol.com)

**Refer to the separate "Parts and Service List" for complete parts and service pricing and ordering information.**

3. No liability whatsoever can be accepted in the case of criminal misuse, negligence, resale, use under the influence of drugs or alcohol, modifications, careless handling, etc.

4. With the Slide removed, it is not permitted to tension and release the Striker forward since this could damage the Striker Block.

5. No liability whatsoever can be accepted if the pistol is fired with any ammunition other than top-quality, commercially manufactured ammunition of the proper caliber specified on the firearm itself. Inexpertly manufactured or reloaded ammunition must not be used.

NOTE: All liability is excluded in the event that the instructions in this manual are not observed.

## **Shipping Firearms For Service**

Kahr handguns returned to the factory for service or repair should be sent to:

K.A.I.  
130 Goddard Memorial Dr.  
Worcester, MA 01603  
Attn: Service Dept.

Contact Kahr Arms Customer Service Dept. at: (508) 795-3919 to receive a "Return Authorization" Number before shipping a firearm to the factory.

Firearms shipped to the factory must be sent prepaid. THE KAHR SERVICE DEPARTMENT CAN NOT ACCEPT COLLECT SHIPMENTS.

The Federal Firearm Control Act does not prohibit an individual from shipping a firearm directly to the manufacturer for service or repair. However, some states or localities prohibit this. If you live in such a location, have a Federally Licensed Firearms dealer ship the firearm. It will be returned to the dealer after being serviced.

Handguns must be shipped prepaid via UPS AIR or FEDEX. Persons who do not hold a Federal Firearms License are prohibited by federal law from shipping a handgun by mail. Handguns mailed in violation of the law are impounded by the Post Office.

Enclose a letter that includes reference to the factory "Return Authorization" Number, your name, address, telephone number, and serial number and model of the firearm. Describe in detail the trouble you have experienced with your firearm, or the work you wish to have done. Stating only that the firearm "needs repair" is inadequate information. Please enclose copies of any previous correspondence.

Please do not include holsters, custom grips, or accessories with any firearm being shipped to the factory for service.

Service work performed, other than approved Warranty repairs, will carry a minimum charge of \$15.00 plus a \$15.00 return shipping and handling charge.



**Notes:**

**Notes:**

**Notes:**

# Limited Lifetime Warranty

This "LIMITED LIFETIME WARRANTY" has been drafted to comply with the MAGNUSON-MOSS WARRANTY FEDERAL TRADE COMMISSION IMPROVEMENT ACT which is effective for goods manufactured on or after December 31, 1976. KAHR ARMS warrants that this firearm was originally manufactured free of defects in material or workmanship.

For the lifetime of the original purchaser, KAHR ARMS agrees to correct any defect in this firearm for the original purchaser by repair or replacement (with same or comparable quality model). A service and/or handling charge may be applied.

THIS WARRANTY IS VOID IF THE FIREARM HAS BEEN ABUSED, MISUSED, DAMAGED BY ACCIDENT, FIRED WITH HANDLOADED AND/OR RELOADED OR IMPROPER AMMUNITION OR WITH AN OBSTRUCTION IN THE BARREL, OR DAMAGED THROUGH FAILURE TO PROVIDE REASONABLE AND NECESSARY MAINTENANCE AS DESCRIBED IN THIS MANUAL. THIS WARRANTY DOES NOT APPLY TO NORMAL WEAR OF ANY PARTS, INCLUDING METAL, WOOD, PLASTIC, RUBBER AND OTHER MATERIAL'S SURFACE FINISH OR IF UNAUTHORIZED REPAIR AND/OR ALTERATION HAS BEEN PERFORMED.

The terms of the Warranty cannot be changed except in writing by an officer of Kahr Arms.

Wholesalers and Dealers (unless a KAHR ARMS authorized Warranty repair station) are not authorized to make any Warranty repair or adjustment on behalf of KAHR ARMS.

This Warranty gives only the original retail purchaser specific legal rights. Other rights may also be available which may vary from state to state.

Should repair be required for this firearm, contact Kahr Customer Service at Tel: (508) 795-3919 or Fax: (508) 795-7046 and request a "Return Authorization" Number. Provide full details of the defect or malfunction, date of purchase and dealer from whom the firearm was purchased. Then, send the unloaded pistol, prepaid via UPS AIR or FEDEX, with a copy of the sales receipt and "Return Authorization" Number to:

**Kahr Arms – Service Dept.  
130 Goddard Memorial Drive  
Worcester, MA 01603**

Web Address: [www.kahr.com](http://www.kahr.com) / [www.kahrshop.com](http://www.kahrshop.com)

E-mail: [kahrsl@aol.com](mailto:kahrsl@aol.com)