

OPERATION AND MAINTENANCE MANUAL



MILITARY ARMAMENT CORPORATION

TABLE OF CONTENTS

FOREWORD	1
1. INTRODUCTION	1
A. Technical Specifications	2
2. CONSTRUCTION	3
3. OPERATION OF THE WEAPON	4
A. Loading Magazines	4
B. Stock Assembly	6
C. Loading and Cocking the Weapon	7
D. Charging the Weapon	7
E. Inserting the Magazine	8
F. Placing the Weapon on "Safe"	8
G. Removal of Magazine	9
H. Fire Selector Lever Operation	9
I. Firing the Submachine Gun	10
J. Malfunctions	10
4. STRIPPING AND REASSEMBLING	13
A. Field Stripping	13
1) Removing Upper Receiver	13
2) Removing the Bolt	15
3) Removing the Stock	16
B. Trigger Mechanism	16
C. Extractor	16
D. Recoil Spring	16
E. Receiver Pin Catch	16
F. Magazine Catch	16
G. Safety Catch	17
H. Stock Latch	17
I. Magazine	17
5. REASSEMBLY	17
6. CLEANING AND MAINTENANCE	18
7. ILLUSTRATIONS	20
8. PARTS LIST	21

FOREWORD

This manual is published for the information and guidance of personnel whose duties involve the use, maintenance and repair of the M10 SMG and the M11 SMG. Disassembly, assembly, cleaning and minor repairs may be undertaken in the field.

In all cases where the nature of the repair or adjustment is beyond the scope of facilities of the unit, the Manufacturer should be informed in order that trained personnel with suitable tools and equipment may be provided.

1. INTRODUCTION

The Ingram Model 10 and Model 11 represent a significant break through in compact submachine gun design. The M10 is available in 9MM Para and .45 ACP calibers, the M11 in .380 ACP caliber.

Both Models are light in weight, durable steel construction and easy to fire, either semi-automatic or full automatic.

The compact size of the M10 makes it especially suitable for tank crews, gun and mortar crews, etc., and its selective fire capability makes it an excellent weapon for police use.

The addition of a noise suppressor further enhances the performance, reducing the noise and eliminating muzzle flash.

The weapon operates on the straight blowback principle and is magazine fed.

A. TECHNICAL SPECIFICATIONS

	Model 10 .45 ACP		Model 10 9MM Para.		Model 11 .380 ACP	
	Inches	MM	Inches	MM	Inches	MM
GUN DIMENSIONS WITHOUT SUPPRESSOR						
Length without stock	10.50	267	10.50	267	8.75	222
Length stock telescoped	11.60	295	11.60	295	9.81	249
Length stock extended	21.57	548	21.57	548	18.11	460
Barrel Length	5.75	146	5.75	146	5.06	129
Maximum width	1.96	50	1.96	50	1.36	35
GUN DIMENSIONS WITH SUPPRESSOR ATTACHED						
Length without stock	20.35	517	20.35	517	16.25	413
Length stock telescoped	21.45	545	21.45	545	17.31	440
Length stock extended	31.42	798	31.42	798	25.61	650
Maximum width	2.13	54	2.13	54	1.75	44
SUPPRESSOR DIMENSIONS						
Length	11.44	291	11.44	291	8.81	224
Diameter	2.13	54	2.13	54	1.75	44
WEIGHT AND CAPACITY						
	Lbs.	Kg.	Lbs.	Kg.	Lbs.	Kg.
Gun without magazine	6.25	2.81	6.25	2.81	3.50	1.57
Suppressor	1.20	0.54	1.20	0.54	1.00	0.45
Loaded 16 round magazine	—	—	—	—	0.62	0.27
Loaded 30 round magazine	2.15	0.97	—	—	—	—
Loaded 32 round magazine	—	—	1.37	0.61	1.12	0.54
TYPE OF FIRE	Semi-automatic or full automatic					
CYCLIC RATE OF FIRE, M10/.45 ACP	Minimum 950 rounds per minute					
M10/9MM Para	Minimum 950 rounds per minute					
M11 .380 ACP	Minimum 1200 rounds per minute					
FRONT SIGHT	Protected post					
REAR SIGHT, M10	Fixed aperture for 100 meters					
M11	Fixed aperture for 50 meters					
SAFETIES	Manually operated safeties for locking bolt in open or closed position					

2. CONSTRUCTION

The weapon consists of the following major components:

**Barrel, Receiver, Bolt, Frame, Firing
Mechanism, Magazine, and Extendable Stock**

A sling swivel is attached to the barrel and receiver assembly. The front end of the barrel is threaded to accept a suppressor. The receiver is fitted with a fixed front sight and houses the bolt, recoil spring, buffer and ejector rod. The frame carries the receiver group, trigger mechanism, magazine housing, stock guide, and safety assembly.

The trigger mechanisms consist of sear, sear spring, selector lever, retainer, trip, trigger, trigger pin, trigger spring, and disconnecter.

The stock is designed to telescope into the frame when not in use thereby reducing the overall size of the weapon.

The bolt assembly on the Model 10 and Model 11 is fitted with a cocking handle. Both models have fixed firing pins. The extractor on the Model 10 operates on the leaf spring principle while the Model 11 utilizes a compression spring.

The magazine for the Model 10 .45 ACP and Model 11 .380 ACP caliber are both of the double column single position feed type, while the Model 10/9MM Para caliber is of the double column two position feed type.

3. OPERATION OF THE WEAPON

A. Loading Magazines

9 MM Para—32 rounds capacity

Hold the magazine in one hand, insert the cartridge, one at a time through the mouth of the magazine ensuring that the base of each cartridge is against the rear of the magazine. (See Fig. 1)

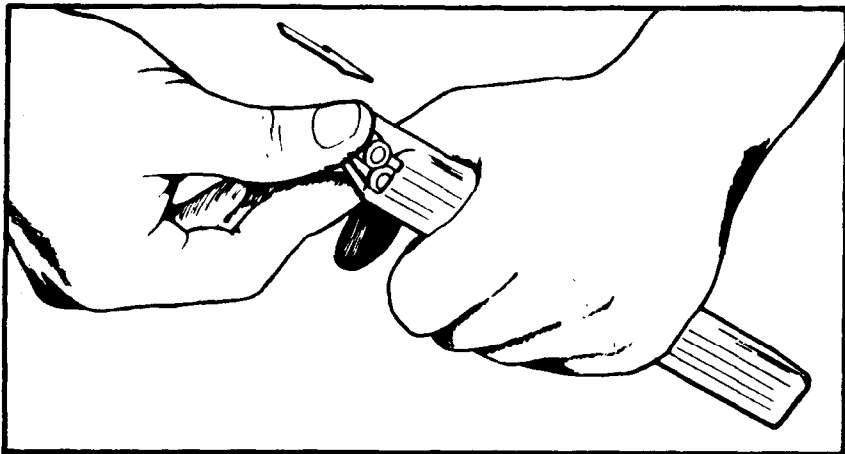

FIG. 1 Pushing Cartridge Under Magazine Feed Lips

Loading Magazines

.45 ACP—30 Rds. Capacity

.380 ACP—32 Rds. Capacity

Place the magazine loader on top of the magazine, then place the base of the magazine on a firm surface. Push down on the loader to depress the magazine follower. Insert a cartridge, base first, into the magazine. Lift the loader, and push the cartridge all the way into the magazine. Push down on the loader, depressing the cartridge and magazine follower. Repeat the operation (Fig. 2) until the magazine is full.

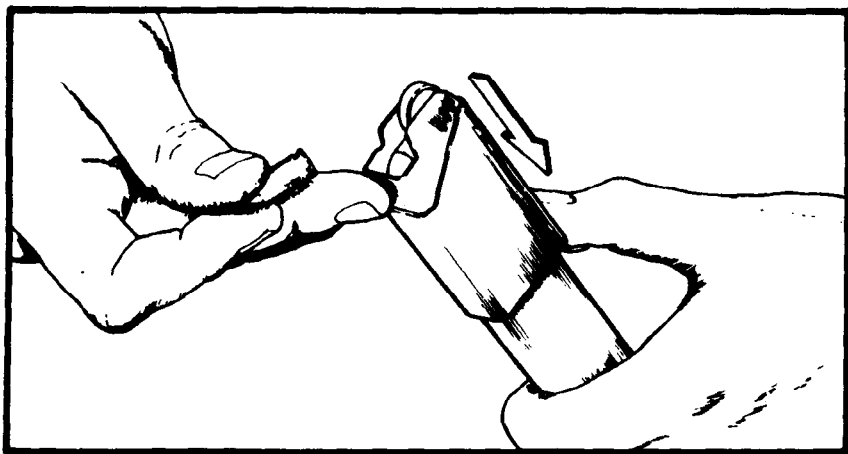

Fig. 2 Pull Down On Loader, Insert Cartridge

B. Stock Assembly

Hold weapon in left hand, with right hand press inwards on right side of wire form butt near the pivot to allow wire form stock to rotate clockwise to normal firing position. (See Fig. 3)

Still holding weapon in left hand depress stock latch button and extend stock assembly using right hand. (See Fig. 4)

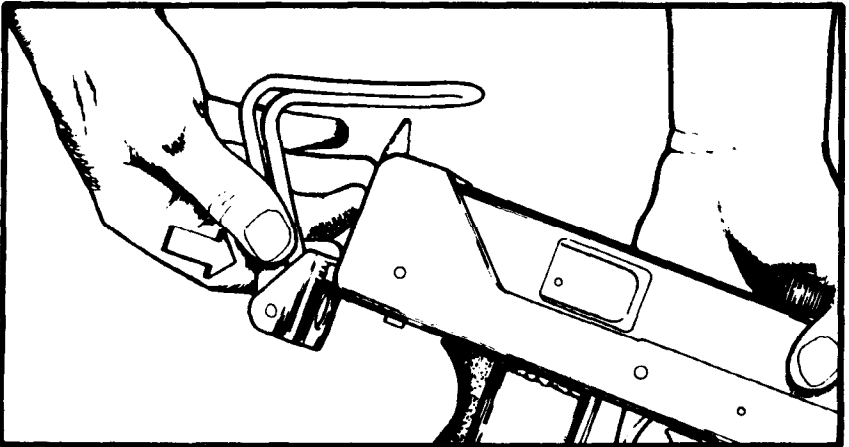

Fig. 3 Disengaging Wire Form from Retaining Pin

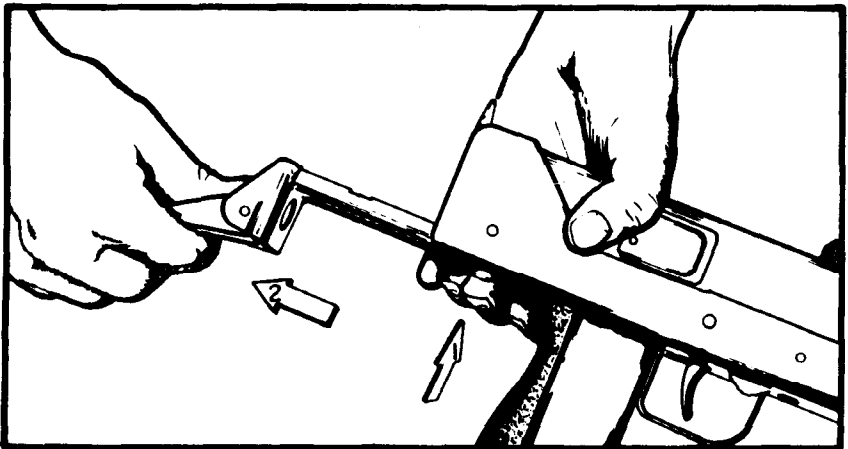

Fig. 4 Extending Stock Assembly

C. Loading and Cocking the Weapon

Move frame safety lever to 'fire' position. Holding the gun by the pistol grip in the right hand and keeping the index finger outside the trigger guard pull back on the cocking handle to the rear with the left hand until the bolt is held to the rear by the sear. (See Fig. 5) Move safety lever to 'safe' position.

Insert loaded magazine in its housing until the magazine catch engages magazine. (See Fig. 6) Select 'semi' or 'auto' fire as required, move frame safety to 'fire' position.

The gun is now ready to fire.

D. Charging the Weapon

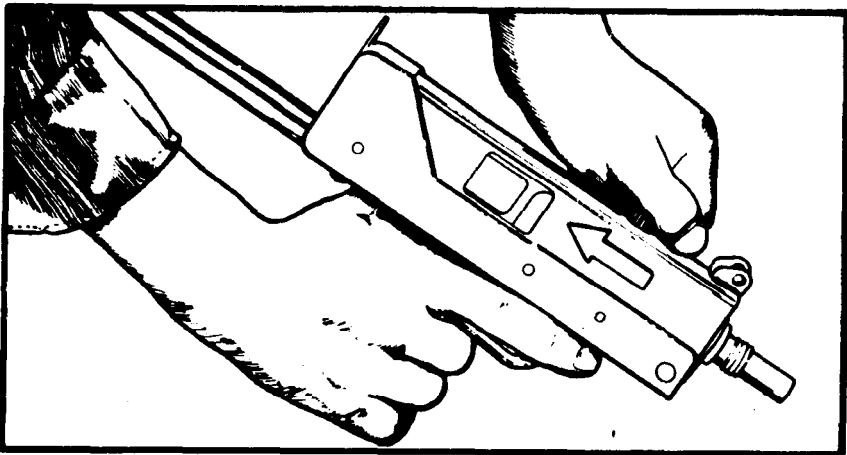

FIG. 5

E. Inserting the Magazine

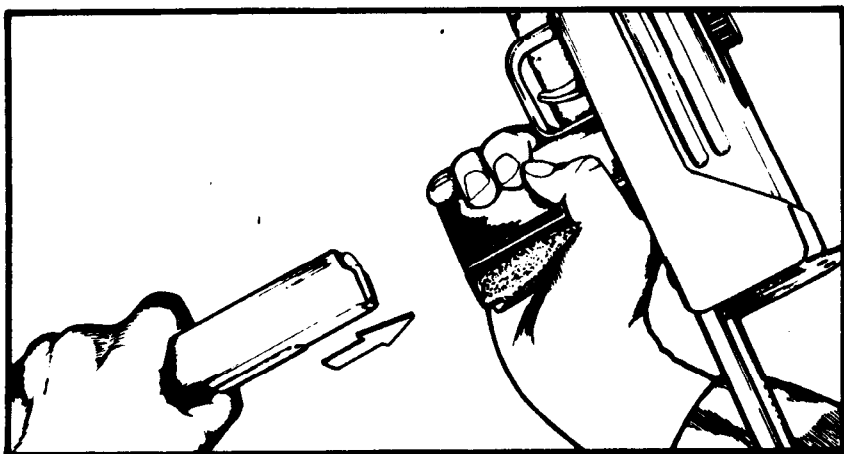

FIG. 6

F. Placing the Weapon on "Safe"

The safety is located on the right of the underside of the frame, it moves front to back, front is the 'fire' position and back is the 'safe' position. (See Fig. 7)

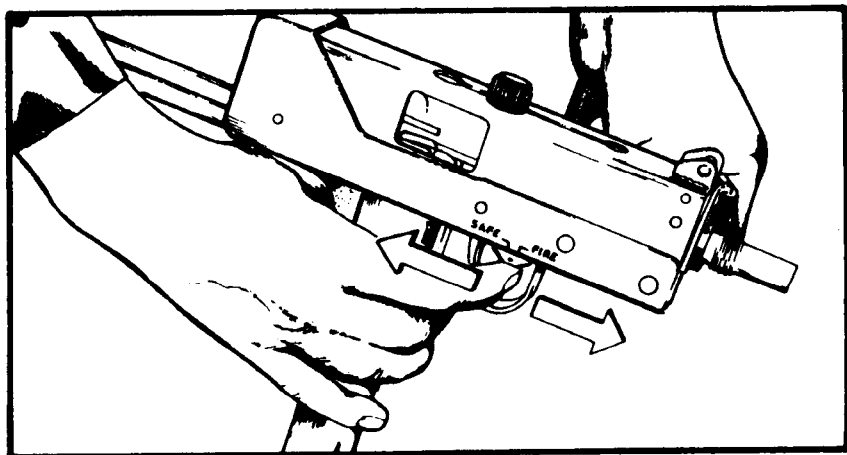

FIG. 7

G. Removal of Magazine

Grasp magazine in left hand and with left thumb press magazine catch to release magazine. (See Fig. 8)

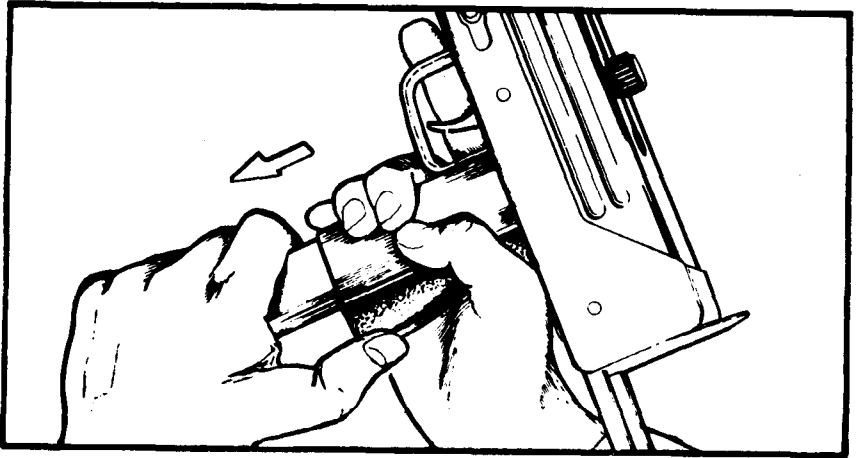

FIG. 8

H. Fire Selector Lever Operation

Located on the left side of the frame the selector is rotated to select 'semi' automatic or 'full' automatic fire. (See Fig. 9)

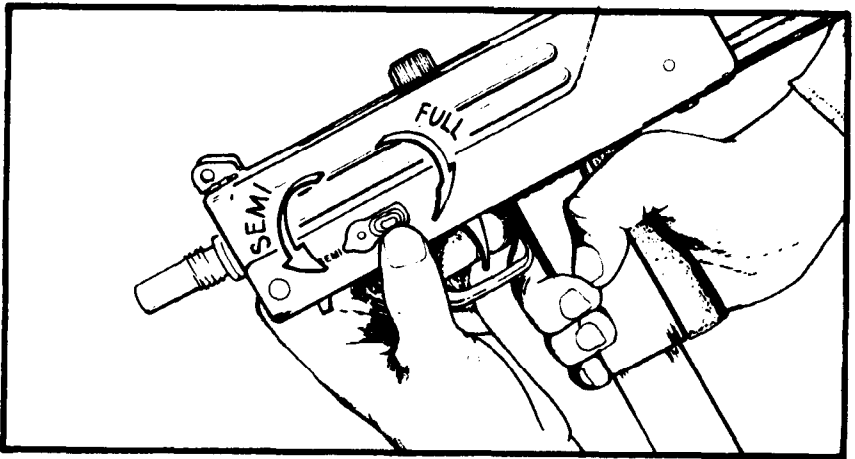

FIG. 9

I. Firing the Submachine Gun

As the bolt is moved back to the cocked position, the recoil spring is compressed and the sear engages the sear notch of the bolt. When the trigger is pressed, the sear releases the bolt, which is driven forward by the recoil spring. During this forward movement, the bolt strips a cartridge from the magazine into the chamber. The bolt continues forward and fires the cartridge. When the cartridge is fired, the chamber pressure forces the bullet out of the muzzle of the barrel. At the same time, this pressure overcomes the forward movement of the bolt and starts it to the rear. By the time the bolt and empty case have moved to the rear far enough to open the rear of the chamber, the bullet has left the barrel, and the chamber pressure has diminished. (In the submachine gun, the chamber pressure is relatively low and the bolt is relatively heavy; this eliminates the need for positive locking and unlocking.) During the rearward movement of the bolt, the empty cartridge case is extracted and ejected, the recoil spring is compressed and the top round in the magazine moves up against the lips of the magazine. The rearward movement of the bolt is stopped by contact with the buffer plate.

J. Malfunctions

Malfunctions are usually the result of worn parts or improper care of the gun. A knowledge of how the gun functions enables the user to classify and correct the malfunction. Listed below are the types of malfunctions which might occur.

1. **Failure to Feed.** The top cartridge in the magazine is not positioned up and in front of the bolt. Most malfunctions of the submachine gun are failures to feed caused by a defective or dirty magazine.

2. **Failure to Chamber.** The top cartridge from the magazine is not seated in the chamber.
3. **Failure to Fire.** The cartridge is chambered but does not fire.
4. **Failure to Extract.** If the cartridge fires, the chamber pressure will normally push the empty cartridge case out of the chamber. If the cartridge case is not completely removed from the chamber and the bolt is retracted, then there is a failure to extract. This malfunction seldom occurs.
5. **Failure to Eject.** The empty cartridge case is not ejected from the weapon.
6. **Failure to Cock.** If the bolt is retracted and is not held by the sear, or if, during firing, the bolt does not move to the rear far enough to clear the top cartridge in the magazine, the gun fails to cock.

Common Malfunctions. The two most common malfunctions are:

1. Failure to feed—usually caused by a defective magazine.
2. Failure to fire—usually caused by defective ammunition.

Causes of Malfunctions. The following chart lists common causes of various malfunctions and corrective action.

Malfunctions	Cause	Corrective Action
Failure to feed.	Dirty or dented magazine.	Replace magazine.
	Weak or broken magazine spring.	Replace magazine.
	Worn magazine notch.	Replace magazine.
	Corroded ammunition.	Replace ammunition.
	Worn or broken magazine catch.	Replace magazine catch.
Failure to chamber.	Dirty chamber	Clean chamber.
	Obstruction in chamber.	Remove obstruction.
	Weak recoil springs.	Replace recoil spring.
Failure to fire.	Defective ammunition.	Replace ammunition.
	Defective firing pin.	Replace bolt.
	Weak recoil springs.	Replace recoil springs.
Failure to extract.	Broken extractor.	Replace extractor.
Failure to eject.	Broken ejector.	Replace ejector.
	Broken or missing extractor.	Replace extractor
Failure to cock.	Worn sear.	Replace sear.
	Worn sear notch.	Replace bolt.
	Bent guide rods.	Straighten.
	Low powered ammunition	Replace ammunition

Prevention of Malfunctions. Periodic inspection and proper care and cleaning will reduce the possibility of the submachine gun malfunctioning.

4. STRIPPING AND REASSEMBLING

The Model 10 and Model 11 have been designed so that no special tools are necessary in order to strip or reassemble the weapon.

Stripping

Before starting to strip the weapon remove the magazine and check the barrel chamber by looking through the EJECTION PORT to make sure there are no live rounds in the weapon.

A. Field Stripping consists of

1) Removing Upper Receiver (Cock Weapon)

Push receiver pin catch back and remove receiver pin. (See Fig. 10). On alternate configuration where there is no receiver pin catch, a sharp push on the receiver pin is all that is required for removal.

Push upper receiver from frame. (See Fig. 11)

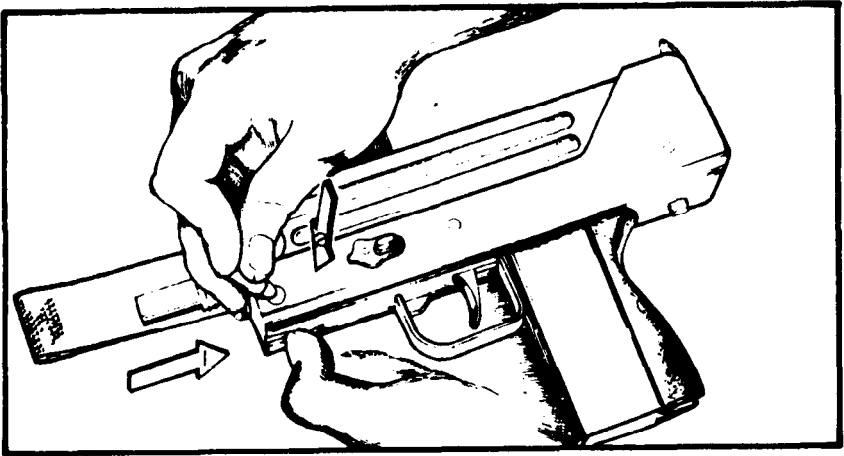

FIG. 10 Removing Pin Securing Receiver Group

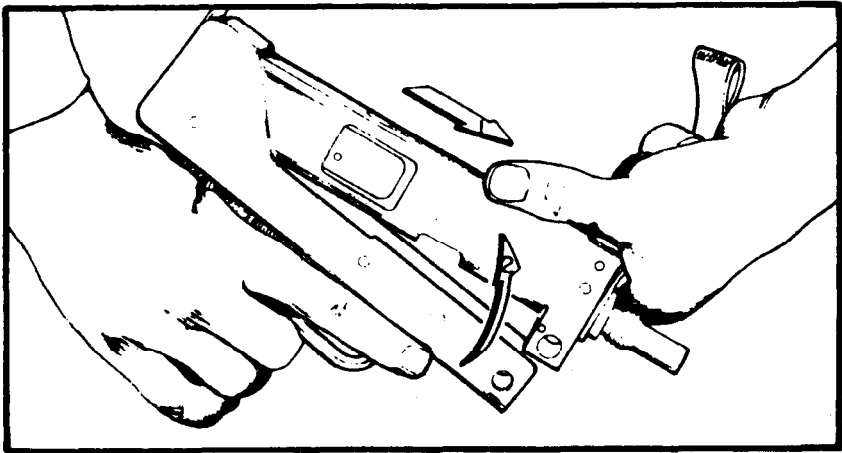

FIG. 11 Removing Barrel and Receiver Group

2) Removing the Bolt

Slide cocking handle to rear of guide slot, rotate handle a few degrees and pull from bolt. (See Fig. 12) The bolt and recoil spring assembly can now be removed from the rear of the receiver. (See Fig. 13)

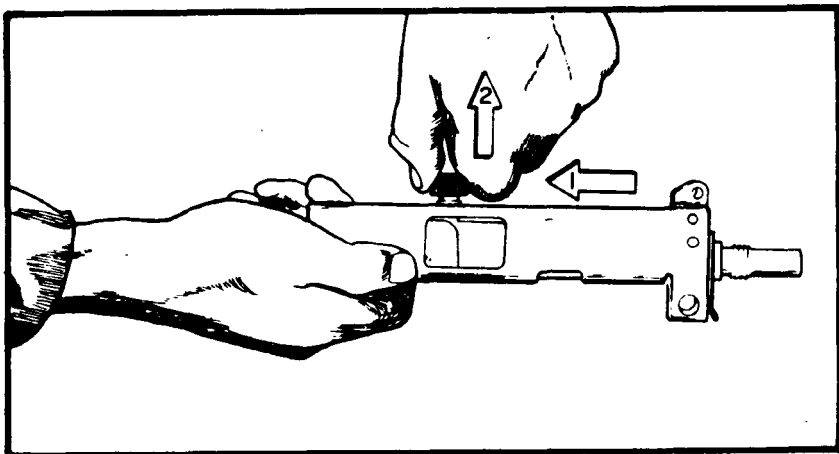

FIG. 12 Removing Cocking Handle

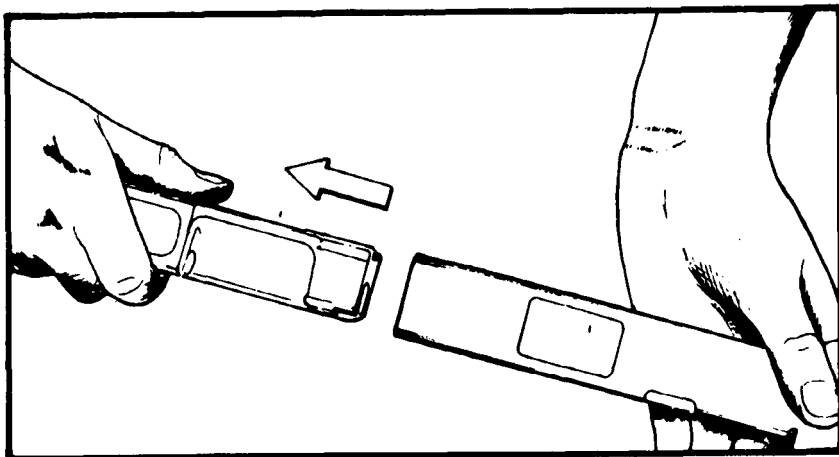

FIG. 13 Bolt Remover from Rear of Receiver

3) Removing the Stock

To remove stock, depress stock latch button and keeping pressure on button pull stock completely out. (see Figs. 3 and 4)

The procedure mentioned above is generally sufficient for normal maintenance and cleaning. If necessary to clean trigger mechanism, removal is as follows:

B. Trigger Mechanism

Lift retainer and remove selector lever, this also allows removal of sear, sear spring and tripping lever. Push trigger pin out of the left side for removal of trigger or torsion spring. Note: for re-assembly, free arm of torsion spring is located on rear side of disconnecter. Disconnecter may be replaced by using a pin punch to remove spring pin.

C. Extractor

Use pin punch to remove extractor spring pin.

D. Recoil Spring

Compress spring and move guide rod clear of bolt and use pin punch to remove spring pin from guide rod.

E. Receiver Pin Catch

Use pin punch to remove spring pin.

F. Magazine Catch

Use flat bladed screw-driver to remove screw in hand grip for access to catch.

G. Safety Catch

Use pin punch to remove catch spring pin.

H. Stock Latch

Press down lightly at center of pin and slide to either side to remove retaining pin. Invert frame and latch will drop out.

I. Magazine

M10/9MM Para, M11 .380 ACP

Depress stud in floor plate and slide plate from magazine case. Keeping finger over the bottom of the magazine to prevent the magazine spring from flying out. Remove the magazine spring and the magazine follower.

M10/45 ACP

Lift the tab in the floor plate by inserting a screw-driver in the hole. Remove base plate, placing the finger over the bottom of the magazine to prevent the magazine spring from flying out.

Remove the magazine spring and the magazine follower.

NOTE: To achieve the proper functioning when reassembling the M11 and M10/45 magazine ensure that the slope of the top coil of the spring corresponds with the slope on the follower.

5. REASSEMBLY

Items are reassembled in the reverse order to the stripping procedure.

6. CLEANING AND MAINTENANCE

It is essential for reliable operation and performance that the weapon receive careful maintenance. It should be cleaned at the end of each day's firing.

The Gun need only be "field stripped" for this maintenance.

Barrel and Receiver Group Cleaning

- A. Use cleaning rod, patch and solvent. Stubborn residue can be removed with a bristle bore brush.
- B. Swab bore with patch saturated in solvent.
- C. Use solvent saturated patch and swab inside of receiver to remove residue.
- D. Use clean dry patch to dry barrel and inside of receiver group.
- E. Dampen patch with light oil and swab barrel and receiver.

Bolt Assembly Cleaning

- A. Remove powder residue with solvent and patch.
- B. Wipe all surfaces of bolt to remove carbon. The bolt face should be completely free of carbon and other residue.
- C. Wipe dry and apply a light coat of oil.

Frame Assembly Group Cleaning

- A. Remove residue build-up on exposed surfaces with solvent-soaked cloth.

- B. Clean around the lockwork. The weapon is designed to tolerate some dirt in the frame group but excessive dirt will impair operation. Detail cleaning is required after prolonged operation or improper functioning of weapon.
- C. Wipe dry and use oily patch to coat exposed metal areas with light film of oil.

Magazine Cleaning

- A. Inspect magazine for damaged areas. Damaged magazines should be discarded.
- B. Clean lip area and top of the follower.
- C. Wipe with oily patch.

Suppressor Cleaning

The suppressor requires no other maintenance apart from ensuring that the bore is kept clear of obstructions. Inspection must be made with the suppressor removed from the weapon. The front end cap of the suppressor is replaceable. It should be replaced after each 500 rounds of firing or sooner if the noise level has increased significantly.

**MAC MIO
45 ACP**

Drawing: Benfield
Date: 28 MAY 1971

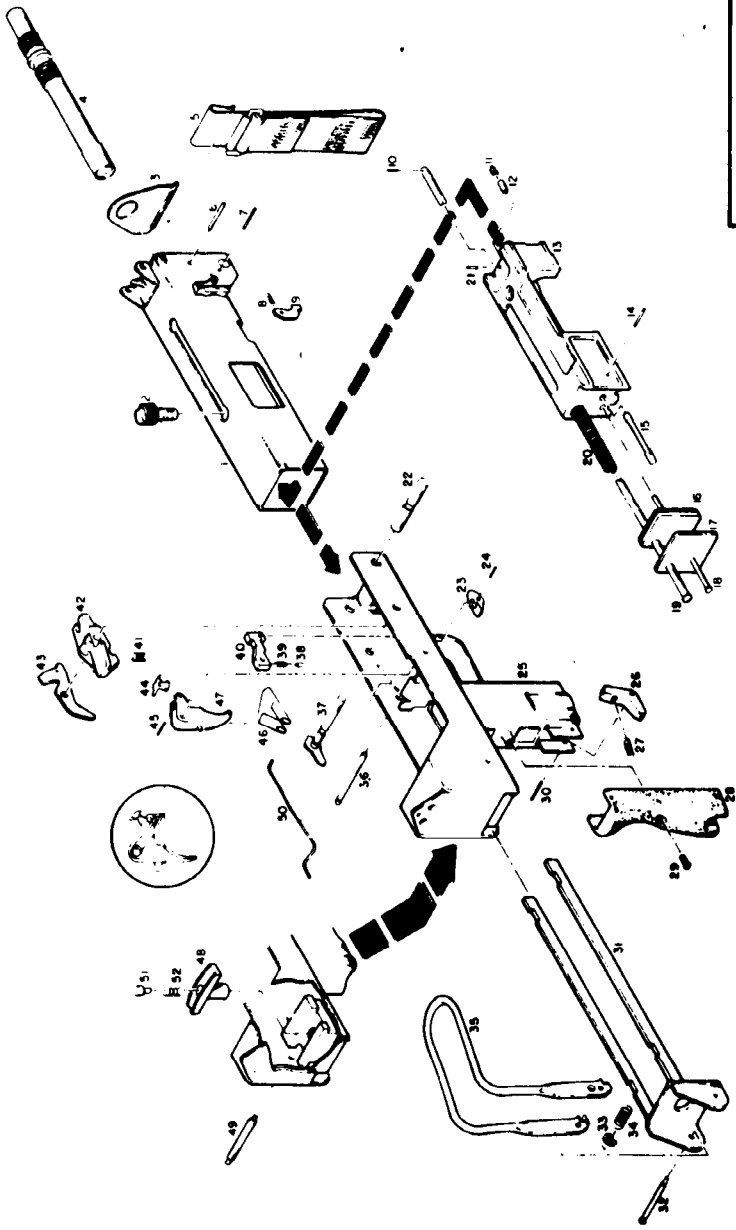

8. M10/45 SUBMACHINE GUN

ILLUSTRATED PARTS LIST

Item	Title	Part No.
1.	Receiver	150309
2.	Bolt Handle	150012
3.	Hanger	150395
4.	Barrel	150063
5.	Strap Assembly	150394
6.	Spring Pin, Barrel	150032-4
7.	Spring Pin, Receiver Pin Catch	150032-6
8.	Compression Spring, Receiver Pin Catch	150025-11
9.	Pin Catch	150039
10.	Spring Pin, Recoil Spring Rod	150032-5
11.	Compression Spring, Bolt Handle Detent	150611
12.	Bolt Handle Detent	150037
13.	Bolt	150073
14.	Spring Pin, Extractor	150032-6
15.	Extractor	150021
16.	Buffer	150047
17.	Plate	150024
18.	Ejector	150023
19.	Guide Rod	150022
20.	Compression Spring, Recoil	150616
21.	Spring Pin, Bolt Handle Detent	150032-2
22.	Receiver Pin	150038
23.	Button	150169
24.	Spring Pin, Safety	150032-9
25.	Frame Assembly	150081
26.	Magazine Catch	150465
27.	Compression Spring, Magazine Catch	150598
28.	Grip	150068

29.	Grip Screw	150043
30.	Magazine Catch Pin	150041
31.	Stock Rail	150088
32.	Stock Hinge Pin	150462
33.	Retaining Ring	150460
34.	Compression Spring, Stock Hinge	150612
35.	Wire Form Butt	150155
36.	Trigger Pin	150016
37.	Sear Pin	150252
38.	Safety Detent Plunger	150293
39.	Compression Spring, Safety Detent	150597
40.	Safety Slide	150168
41.	Compression Spring, Sear	150594
42.	Sear	150070
43.	Trip	150268
44.	Disconnecter	150249
45.	Spring Pin, Disconnecter	150032-5
46.	Torsion Spring, Trigger	150539
47.	Trigger	150448
48.	Latch	150091
49.	Stock Latch Pin	150094
50.	Retainer	150269
51.	Plunger, Stock Latch	150110-1
52.	Compression Spring, Stock Latch	150598

ACCESSORIES: (Not Included)

Magazine	150111
Magazine Pouch	150072
Magazine Loader	150245
Cleaning Rod	150209
Sling	150459
Suppressor	150216

MAC M10
9 MM

U.S. ARMY
CROSS REFERENCE
PART 9 444 10 71

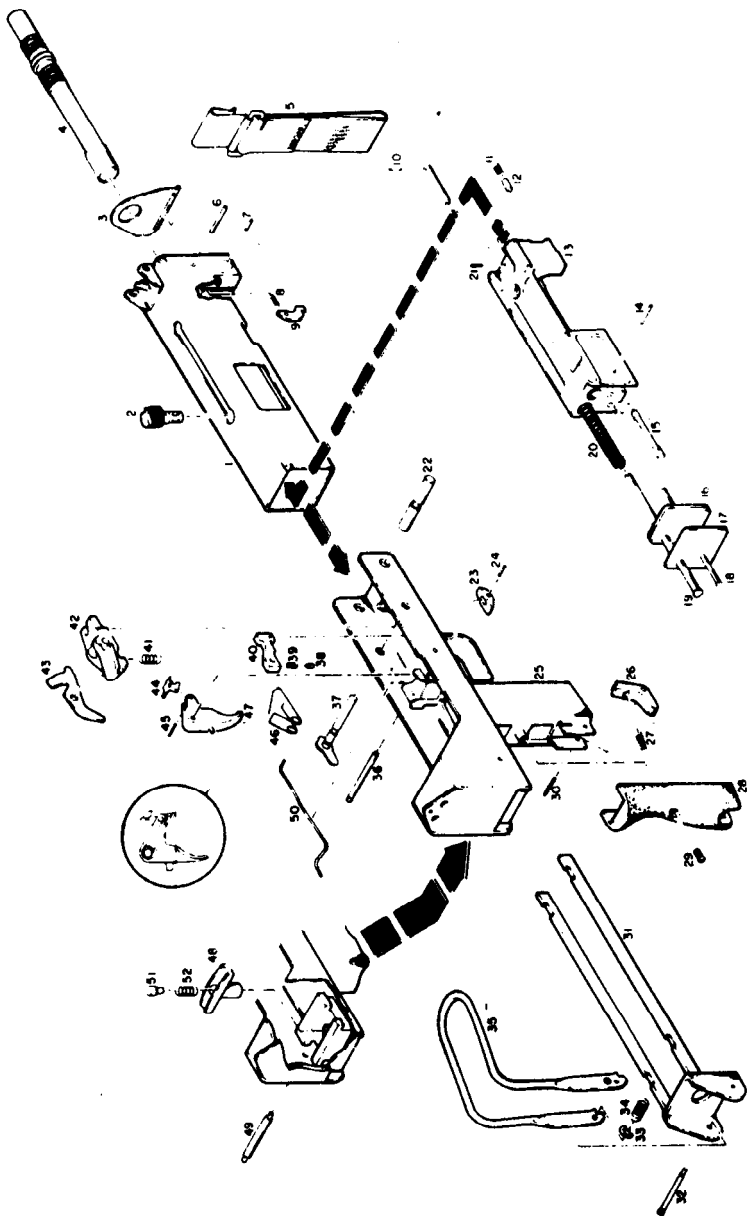

8. M10/9MM SUBMACHINE GUN

ILLUSTRATED PARTS LIST

Item	Title	Part No.
1.	Receiver	150309
2.	Bolt Handle	150012
3.	Hanger	150395
4.	Barrel	150005
5.	Strap Assembly	150394
6.	Spring Pin, Barrel	150032-4
7.	Spring Pin, Receiver Pin Catch	150032-6
8.	Compression Spring, Receiver Pin Catch	150025-11
9.	Pin Catch	150039
10.	Spring Pin, Recoil Spring Rod	150032-5
11.	Compression Spring, Bolt Handle Detent	150611
12.	Bolt Handle Detent	150037
13.	Bolt	150004
14.	Spring Pin, Extractor	150032-6
15.	Extractor	150294
16.	Buffer	150047
17.	Plate	150024
18.	Ejector	150023
19.	Guide Rod	150022
20.	Compression Spring, Recoil	150580
21.	Spring Pin, Bolt Handle Detent	150032-5
22.	Receiver Pin	150038
23.	Button	150169
24.	Spring Pin, Safety	150032-9
25.	Frame Assembly	150010
26.	Magazine Catch	150077
27.	Compression Spring, Magazine Catch	150598
28.	Grip	150068

29.	Grip Screw	150043
30.	Magazine Catch Pin	150041
31.	Stock Rail	150088
32.	Stock Hinge Pin	150462
33.	Retaining Ring	150460
34.	Compression Spring, Stock Hinge	150612
35.	Wire Form Butt	150155
36.	Trigger Pin	150016
37.	Sear Pin	150252
38.	Safety Detent Plunger	150293
39.	Compression Spring, Safety Detent	150597
40.	Safety Slide	150168
41.	Compression Spring, Sear	150594
42.	Sear	150070
43.	Trip	150268
44.	Disconnecter	150249
45.	Spring Pin, Disconnecter	150032-5
46.	Torsion Spring, Trigger	150539
47.	Trigger	150448
48.	Latch	150091
49.	Stock Latch Pin	150094
50.	Retainer	150269
51.	Plunger, Stock Latch	150110
52.	Compression Spring, Stock Latch	150598

ACCESSORIES: (Not Included)

Magazine, Walther Conversion	150115
Magazine Pouch	150072
Magazine Loader	Not Req'd.
Cleaning Rod	150209
Sling	150459
Suppressor	150217

**MAC M11
380 ACP**

Drawn by
L. J. ...
Checked by
...

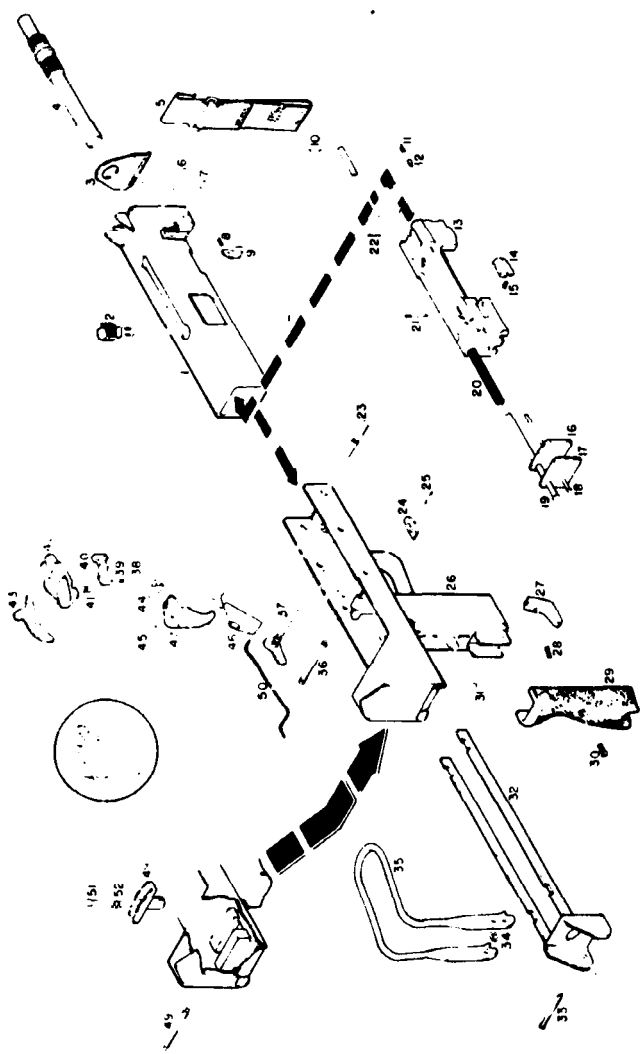

8. M11 .380 SUBMACHINE GUN

ILLUSTRATED PARTS LIST

Item	Title	Part No.
1.	Receiver	150308
2.	Bolt Handle	150121
3.	Hanger	150396
4.	Barrel	150172
5.	Strap Assembly	150393
6.	Spring Pin, Barrel	150032-7
7.	Spring Pin, Receiver Pin Catch	150032-6
8.	Compression Spring, Receiver Pin Catch	150025-11
9.	Pin Catch	150133
10.	Spring Pin, Recoil Spring Rod	150032-3
11.	Compression Spring, Bolt Handle Detent	150618
12.	Bolt Handle Detent	150146
13.	Bolt	150120
14.	Extractor	150129
15.	Compression Spring, Extractor	150614
16.	Buffer	150055
17.	Plate	150148
18.	Ejector	150176
19.	Guide Rod	150175
20.	Compression Spring, Recoil	150617
21.	Spring Pin, Extractor	150032-6
22.	Spring Pin, Bolt Handle Detent	150032-1
23.	Receiver Pin	150177
24.	Button	150169
25.	Spring Pin Safety	150032-9
26.	Frame Assembly	150173-1
27.	Magazine Catch	150077
28.	Compression Spring—Magazine Catch	150598

29.	Grip	150139
30.	Grip Screw	150043
31.	Magazine Catch Pin	150041
32.	Stock Rail	150162
33.	Stock Hinge Pin	150463
34.	Retaining Ring	150460
35.	Wire Form Butt	150534
36.	Trigger Pin	150179
37.	Sear Pin	150248
38.	Safety Detent Plunger	150293
39.	Compression Spring, Safety Detent	150597
40.	Safety Slide	150189
41.	Compression Spring, Sear	150599
42.	Sear	150134
43.	Trip	150264
44.	Disconnecter	150249
45.	Spring Pin, Disconnecter	150032-5
46.	Torsion Spring, Trigger	150615
47.	Trigger	150135
48.	Latch	150145
49.	Stock Latch Pin	150180
50.	Retainer	150270
51.	Plunger, Stock Latch	150110-2
52.	Compression Spring, Stock Latch	150598

ACCESSORIES: (Not Included)

Magazine	150113-1 (32 rd.)
Magazine	150113-2 (16 rd.) opt.
Magazine Pouch	150072
Magazine Loader	150197
Cleaning Rod	150209
Sling	Not Req'd.
Suppressor	150218

<u>ITEM</u>	<u>TITLE</u>	<u>M10/45</u>	<u>M10/9MM</u>	<u>M11</u>
1A	RECEIVER	150634-1	150634-1	150633-1
22A	RECEIVER PIN	150628-1	150628-1	
23A	RECEIVER PIN			150628-2

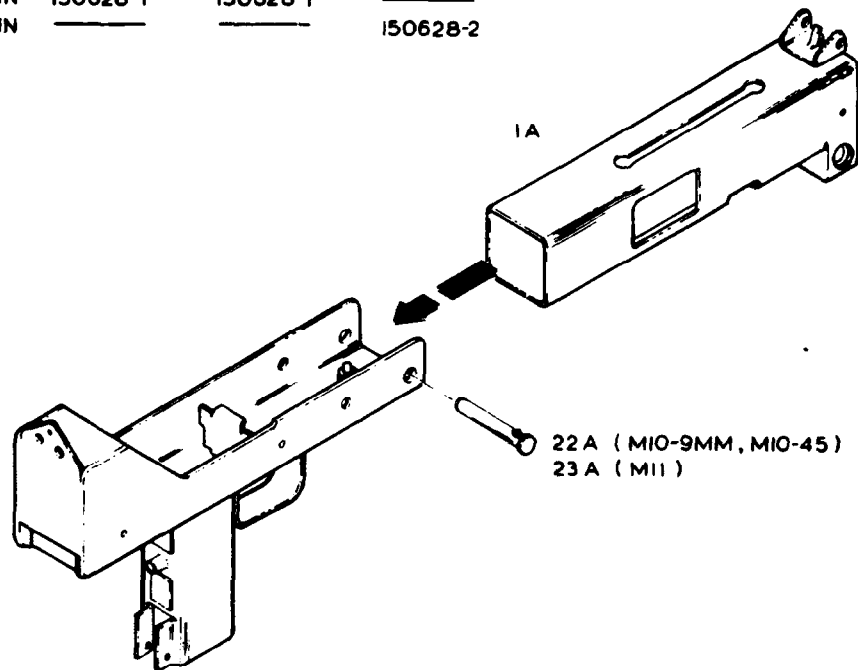

ALTERNATE RECEIVER PIN CONFIGURATION

SUPPRESSOR SHOWING REPLACEABLE END CAP

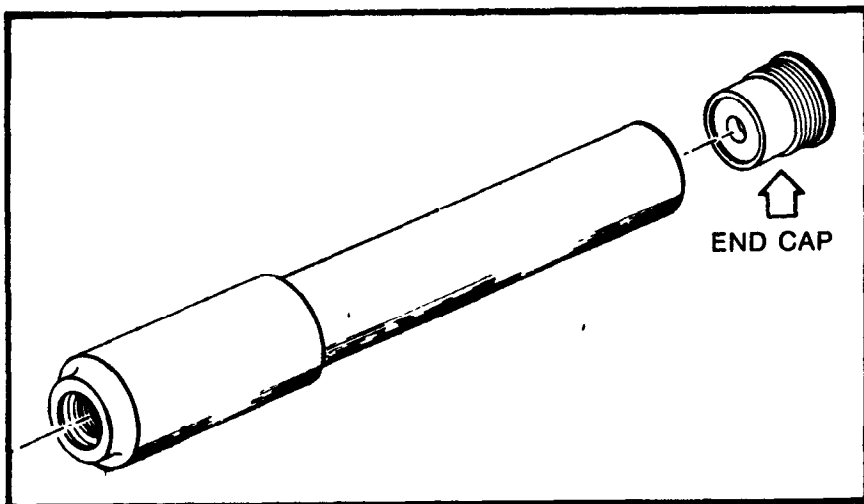

Suppressor M-10/MM

150217

End Cap

150225-1

Suppressor M-10/45 ACP

150216

End Cap

150225-2

Suppressor M-11/.380 ACP

150218

End Cap

150225-1

150461 - BODY

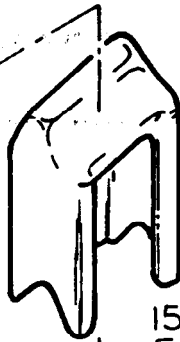
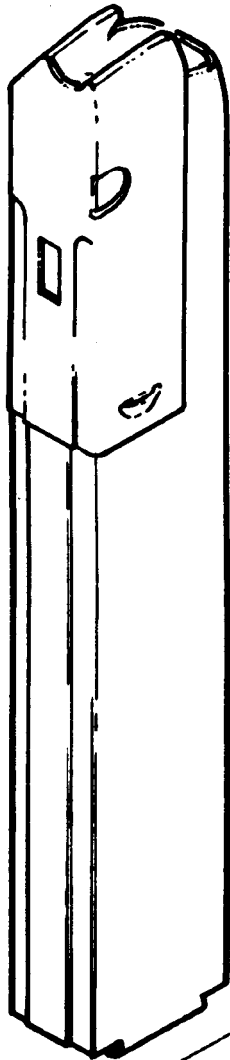

150098 -
FOLLOWER

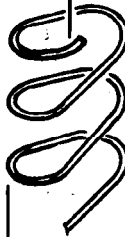

150100-
SPRING

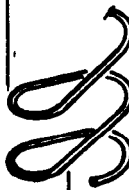

150099-
FLOOR
PLATE

MIO-45 ACP

150237-BODY

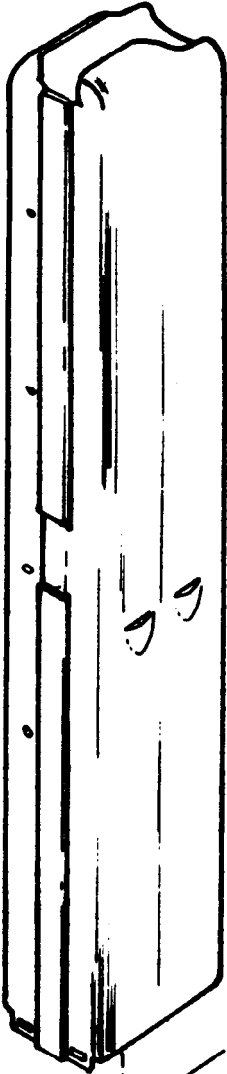

150116 -
FOLLOWER

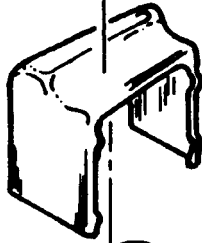

150215 -
SPRING



150240 -
FLOOR
PLATE
RETAINER



150297 -
FLOOR PLATE



150131-BODY
(-1) 32 RD
(-2) 16 RD



150141-FOLLOWER

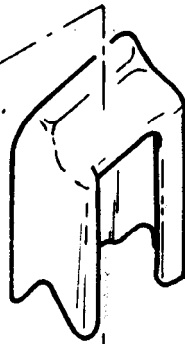

150140-SPRING
(-1) 32 RD
(-2) 16 RD

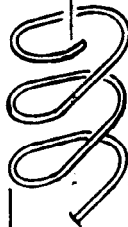

150212 (16 RD)
150181 (32 RD)
FLOOR PLATE
RETAINER

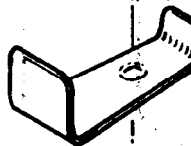

150144-FLOOR PLATE

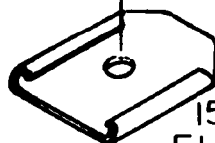

MAC

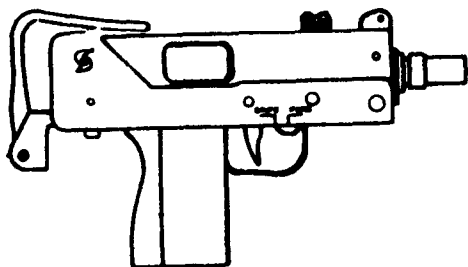

M10 - M11