



BROWNING®

The Best There Is.

OWNER'S MANUAL

VERY IMPORTANT:

Save This Booklet. Carefully read this entire manual before using your new Browning firearm.

Printed in Japan 35123

BL-22 LEVER ACTION RIFLE

NEW GUN OWNERS RECORD

KEEP THIS RECORD FOR FUTURE REFERENCE

Browning Model

Serial Number

Gauge / Caliber

Purchase Price

Purchased From

Date of Purchase

We are pleased that you have chosen a Browning BL-22 lever action rifle.

The BL-22 is certainly a gun you can be proud to own. It has an unequalled reputation for dependability and good handling. The short throw lever design gives you rapid fire, without having to worry about finger pinch. It is truly a rifle that follows in the Browning tradition — superb craftsmanship, handsome styling and proven dependability.

With a reasonable amount of care, the BL-22 should give you many years of dependable, enjoyable service. Please feel free to write us immediately if you have any important observations regarding its performance and operation.

Thank you.



Route One, Morgan, Utah 84050

Distributed in Canada by Browning Canada Sports Ltd./Ltee, St-Laurent, Quebec H4S 1W6

Printed in Japan 93125

BL-22 LEVER ACTION RIFLE

You Are Responsible For Firearms Safety.

As a gun owner, you accept a set of demanding responsibilities. How seriously you take these responsibilities can be the difference between life and death.

There is no excuse for careless or abusive handling of any firearm. At all times handle your BL-22 and any other firearm with intense respect for its power and potential danger.

READ AND UNDERSTAND THE PROPER HANDLING AND INSTRUCTION PROCEDURES OUTLINED IN THIS BOOKLET BEFORE USING YOUR NEW FIREARM.

- 1 **ALWAYS KEEP THE MUZZLE OF YOUR BL-22 POINTED IN A SAFE DIRECTION.** Never point your gun at anything you do not intend to shoot.
- 2 **ALWAYS KEEP THE HAMMER OF YOUR BL-22 IN THE DROPPED POSITION AND YOUR FINGER OFF THE TRIGGER,** even if you are certain the rifle is unloaded. While you should never rely on the dropped hammer position to function as a "safety", it is the preferred carrying position for the hammer on the BL-22. No guarantee can be made that at some time, the dropped hammer position will not prevent the firearm from firing. Like any mechanical device it can sometimes fail and can be jarred or inadvertently manipulated into an unsafe condition. When the BL-22 is stored or cased the hammer should always be placed in the dropped position. Safe gun handling does not stop with your gun's mechanical "safety" devices. It starts

there. Always treat your firearm with the respect due a loaded, ready-to-fire gun.

- 3 **DO NOT USE A HAMMER SPUR.** A hammer spur could result in a malfunction and possibly create a hazardous condition.
- 4 **WHENEVER YOU HANDLE YOUR BL-22, OR HAND IT TO SOMEONE, ALWAYS OPEN THE ACTION IMMEDIATELY** and visually check the chamber, receiver cavity and magazine to be certain they do not contain any cartridges.
- 5 **DO NOT TRANSPORT YOUR BL-22 LOADED, WHETHER IN A SCABBARD, GUN CASE, OR OTHER CONTAINER.**
- 6 **BEWARE OF BARREL OBSTRUCTIONS.** When preparing to shoot your BL-22, open the action and inspect the chamber. **BE CERTAIN NO LIVE ROUND IS IN THE CHAMBER.** Glance down the barrel to be sure it is clear of any obstruction. It takes only a small obstruction to dangerously increase pressures. Before the first firing, clean the bore with a cleaning rod and patch, and wipe away any anti-rust compounds in the chamber and around the action. See "Care and Cleaning" on page 11.
- 7 **BE CERTAIN YOUR RIFLE IS UNLOADED BEFORE CLEANING.** Because so many gun accidents occur when a firearm is being cleaned, special and extreme care should be taken to be sure your gun is unloaded before disassembly, cleaning and reassembly. Keep ammunition away from the cleaning location. Never test the mechanical function of any firearm with live ammunition.
- 8 **ALWAYS UNLOAD YOUR GUN WHEN NOT IN USE.** Your responsibilities do not end when your firearm is unattended. Store your gun and ammunition separately and well beyond the reach of children. Take all safeguards to insure your gun does not become available to untrained, inexperienced or unwelcome hands.

9 **USE THE PROPER AMMUNITION.** The barrel and action of this rifle have been made with substantial safety margins over the pressures developed by established American commercial loads. **Nevertheless, Browning assumes no liability for accidents which occur through the use of cartridges of nonstandard dimensions or which develop pressures in excess of commercially available ammunition which has been loaded in accordance with standards established by SAAMI (Sporting Arms and Ammunition Manufacturers' Institute).**

10 **EXAMINE EVERY CARTRIDGE YOU PUT IN YOUR BL-22.** The caliber is inscribed on the right side of the barrel. **Your BL-22 is designed to shoot 22 Long Rifles, Longs and Shorts.** Browning cannot assume any responsibility for the use of unsafe or improper arms and ammunition combinations. It is your responsibility to read and heed all warnings in this instruction manual and on ammunition boxes.

Serious injury to yourself and damage to your gun may result from improper cartridge use.

11 **DO NOT SNAP THE HAMMER ON AN EMPTY CHAMBER — THE CHAMBER MAY NOT BE EMPTY!**

Treat every gun with the respect due a loaded gun, even though you are certain the gun is unloaded.

12 **KEEP YOUR FINGER AWAY FROM THE TRIGGER WHILE UNLOADING AND LOADING — UNTIL YOU ARE READY TO SHOOT.**

13 **BE SURE OF YOUR TARGET AND BACKSTOP,** particularly during low light periods. Know the range of your ammunition. Never shoot at water or hard objects.

14 **HUNTING FROM ELEVATED SURFACES SUCH AS TREE STANDS IS DANGEROUS** and may increase the risk of mishandling your firearm. The following rules should always be observed by you and those you hunt with: **Always** make certain that the stand being used is safe and stable; **Always** make certain that your firearm is unloaded when it is being taken up and down

the stand; **Always** make certain that your firearm is not dropped from the stand, or dropped while it is being taken up or down the stand. Remember, a loaded firearm may discharge when dropped, even with the safety on.

15 **DROPPING YOUR BL-22 WHEN LOADED CAN CAUSE AN ACCIDENTAL DISCHARGE EVEN WITH THE HAMMER IN THE DROPPED POSITION.** Be extremely careful while hunting or during any shooting activity, to avoid dropping any firearm.

16 **ALWAYS UNLOAD YOUR RIFLE'S CHAMBER AND OPEN THE BOLT BEFORE CROSSING A FENCE, CLIMBING A TREE, JUMPING A DITCH OR NEGOTIATING OTHER OBSTACLES.** Never lean or place your BL-22 against or on a fence, tree, car or other similar object.

17 **IF YOUR BL-22 FAILS TO FIRE, KEEP THE MUZZLE POINTED IN A SAFE DIRECTION.** Hold this position for a minimum of 30 seconds. Carefully open the action and remove

the cartridge. If the rim (primer) is indented, the cartridge should be disposed of in a way that cannot cause harm. If the rim (primer) is not indented, your firearm should be examined by a Browning Recommended Service Center and the cause of the malfunction should be corrected before further use.

18 **WEAR EYE AND EAR PROTECTION WHEN SHOOTING.** Unprotected, repeated exposure to gunfire can cause hearing damage. Wear hearing protectors to protect your ears from loud noise and shooting glasses to protect your eyes from flying particles. Also, wear eye protection when disassembling and cleaning your rifle to prevent the possibility of springs, spring-tensioned parts, solvents or other agents from contacting your eyes.

19 **BE DEFENSIVE AND ON GUARD AGAINST UNSAFE GUN HANDLING AROUND YOU AND OTHERS.** Don't be timid when it comes to gun safety. If you observe other shooters violating any of these safety precautions, politely suggest safer handling practices.

Figure 1

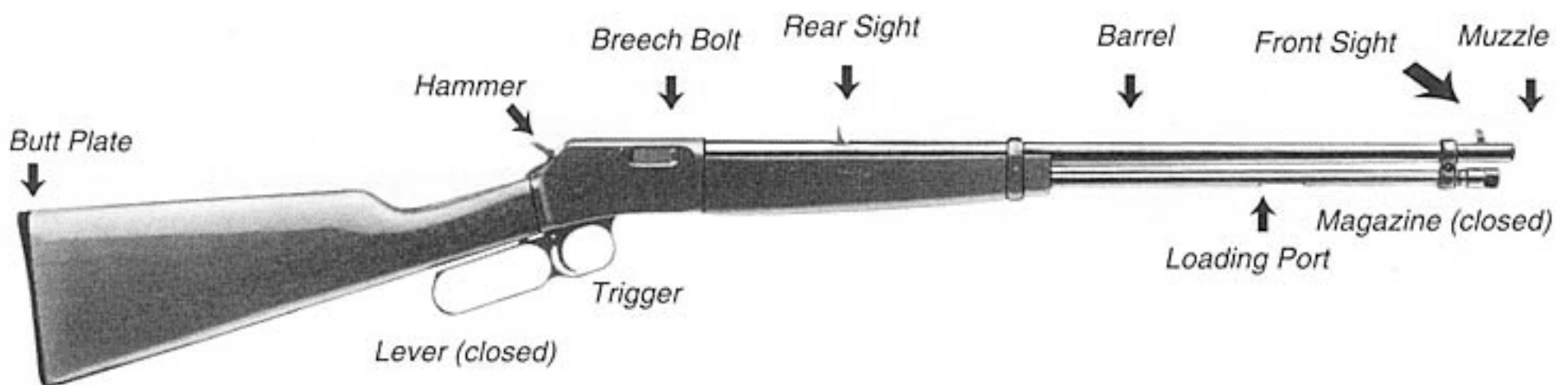

- 20 **SUPERVISE AND TEACH FIREARMS SAFETY TO ALL MEMBERS OF YOUR FAMILY** — especially to children and nonshooters. Closely supervise newcomers to the shooting sports. Encourage enrollment in hunting/shooting safety courses.
- 21 **NEVER DRINK ALCOHOLIC BEVERAGES OR TAKE ANY TYPE OF DRUGS BEFORE OR DURING SHOOTING.** Your vision and judgement could be dangerously impaired, making your gun handling unsafe to you or to others.
- 22 **PERIODIC MAINTENANCE — AVOID UNAUTHORIZED SERVICING.** Your BL-22 is a mechanical device which will not last forever, and as such, is subject to wear and requires periodic inspection, adjustment, and service. Like all Browning firearms, your BL-22 should be serviced by a Browning Recommended Service Center or by Browning's service facility in Arnold, Missouri. Browning cannot assume

any responsibility for injuries suffered or caused by lack of servicing or unauthorized servicing, alterations or modifications of Browning firearms.

IT CAN BE VERY DANGEROUS TO ALTER THE TRIGGER OR OTHER FIRING MECHANISM PARTS OF THIS OR ANY OTHER FIREARM.

BE CAREFUL!

Nomenclature

In conventional gun terminology the position and movement of gun parts are described as they occur with the gun horizontal and in normal firing position; i.e., the muzzle is forward or front; the butt stock is rearward or rear; the trigger is downward or underneath; the sights are upward or on top. When the lever is closed or parallel to the grip stock, the bolt is "closed" or "locked". When the lever is down, the bolt is "open" or "unlocked." For general nomenclature refer to Figure 1.

Figure 2

Serial Number

The serial number can be found on the right side of the receiver at the front.

General Operating Procedures

Your new Browning BL-22 lever action rifle is a western style repeating rifle. With the magazine filled with cartridges, one round in the chamber and with the hammer cocked, the BL-22 will fire a single round when the trigger is squeezed.

Operation of the lever is through a short arc which ejects the empty case, cocks the hammer and chambers a fresh round (see Figure 2). At this point the rifle is ready to fire the second round with a squeeze of the trigger. The sequence of operation may be followed until both the magazine and chamber are empty. When cycling the action, the lever should be operated smoothly, but positively through both the opening and closing movements.

A "safety" interlock prevents the rifle from firing until the lever and breech bolt are fully closed. Another built-in "safety" device prevents the rifle from firing even if the trigger is depressed while the lever is closing. If this should occur, merely release finger pressure from the trigger and the rifle will be ready to fire with the next squeeze of the trigger.

Unpacking Your BL-22

CAUTION! BE SURE YOUR RIFLE UNLOADED! WHEN UNPACKING YOUR RIFLE FOR THE FIRST TIME CHECK TO BE SURE THAT BOTH THE CHAMBER AND MAGAZINE ARE EMPTY.

Initial Cleaning

BEFORE THE FIRST FIRING, CLEAN THE ANTI-RUST COMPOUND FROM THE BARREL with an oiled patch and cleaning rod. Wipe out the inside of the receiver and clean all metal parts with a clean rag and oil such as Browning Oil. For details on cleaning see "Care and Cleaning" on page 11.

Ammunition

The Browning BL-22 lever action 22 rifle must be used only with 22 rimfire ammunition as designated on the barrel (22 Long Rifle, Longs or Shorts). Do not shoot blanks or bird shot cartridges in any of our 22 rifles.

Always read the ammunition label and any enclosures with your ammunition to assure that the am-

munition is appropriate or that there is no restriction for its use with your firearm.

Operation of the Hammer

Like most lever action rifles with exposed hammers, the BL-22 does not have a separate manual safety. While you should never rely on the dropped hammer position to function as a "safety", the exposed hammer itself is an ideal "safety" indicator of the status of the rifle since it alerts the user when the rifle is cocked and ready for firing or when the hammer is in its dropped position. The hammer has three positions: full cock, half cock, and dropped or fired.

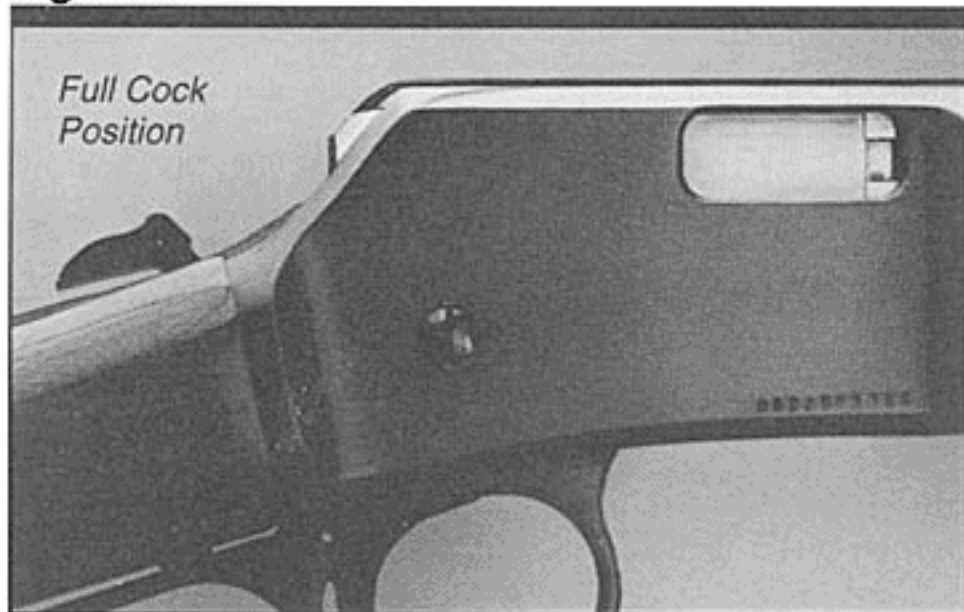
Figure 3

- 1 **FULL COCK POSITION** — The hammer is all the way to the rear (see Figure 3). At this point, any pull or force on the trigger could allow the hammer to fall, firing the rifle.

The hammer can be placed in this position in either of two ways. First, every time the lever is cycled, lever linkages will leave the hammer in the full cock position. Second, the hammer may

Figure 4

- also be placed at full cock by manually moving it rearward with the thumb until it engages the full cock notch. **CAUTION: BE SURE TO KEEP YOUR FINGER OFF THE TRIGGER WHILE COCKING THE HAMMER.**

- 2 **HALF COCK POSITION** — The half cock notch on the hammer is a specific feature designed to protect against accidental discharge of the rifle in the event the hammer slips from the

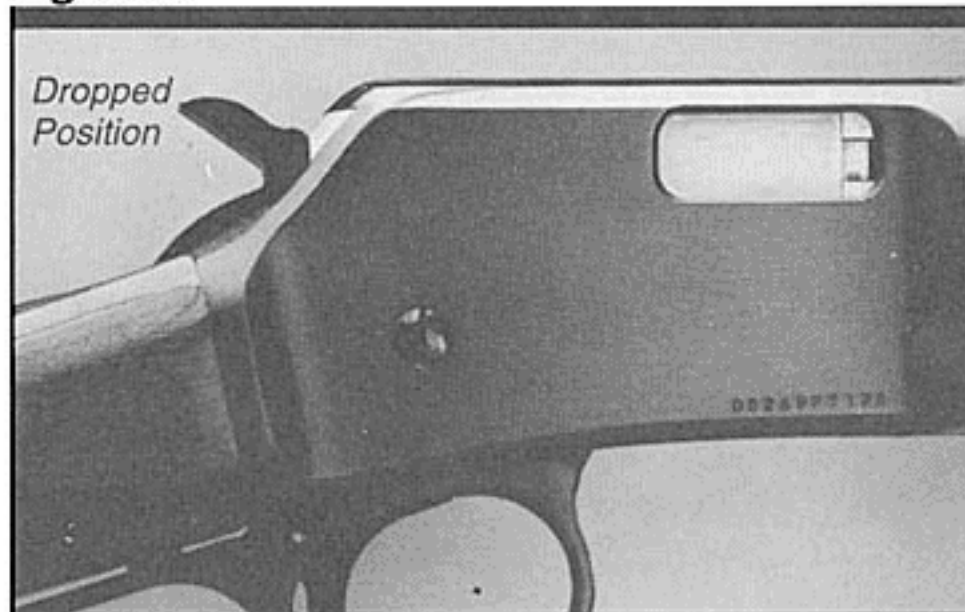
Figure 5

- thumb while the rifle is being cocked. **HALF COCK IS NOT A RECOMMENDED CARRYING POSITION**, nor a position where the hammer should be deliberately placed for handling or storage (see Figure 4).
- 3 **DROPPED OR FIRED POSITION** — In this position the hammer is fully down (see Figure 5). This is the position of the hammer after a

round is fired and it is the recommended position when carrying the rifle afield and for storage. The hammer may be easily and quickly thumbed back to full cock from the dropped position whenever desired.

Dropped Position

In order to move the hammer from full cock to the dropped position, the trigger must be depressed during the entire forward travel of the hammer. Note that **WHEN THE TRIGGER IS DE-PRESSED, THE HALF COCK NOTCH WILL NOT CATCH THE HAMMER IF IT SHOULD ACCIDENTALLY SLIP DURING THIS OPERATION.** Therefore, a wise practice to follow is to place the point of the thumb in the "V" between the hammer and the firing pin so that it can act as a cushion against accidental hammer fall (see Figure 6). The thumb can be easily withdrawn as the hammer approaches the dropped position. When a scope **(Continued on page 9.)**

BROWNING BL-22 LEVER ACTION RIFLE

This schematic is provided for parts identification only and should not be used as a guide to assemble gun.

IMPORTANT: When ordering parts, list code number, part name, caliber, model and serial number.

CAUTION: Browning parts are made exclusively for Browning guns and are not recommended for use in other guns even though models may be similar. Inadequately fitted parts may be dangerous.

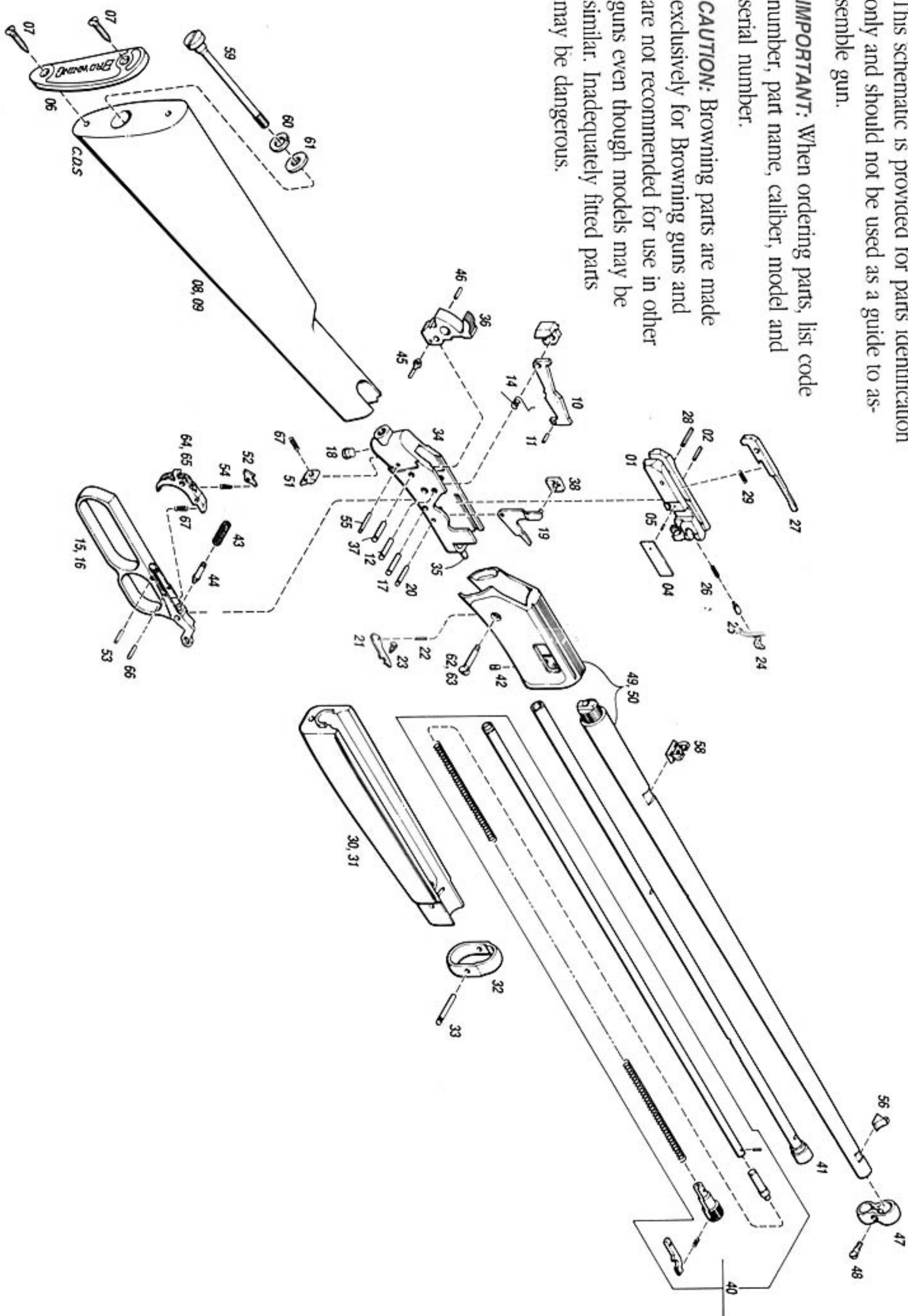

Parts List**Browning Model BL-22 Lever Action 22 Caliber Rifle**

KEY NO.	PART NO.	DESCRIPTION	KEY NO.	PART NO.	DESCRIPTION
01	*P064506	Bolt	37	P064612	Hammer Pin
02	P064508	Bolt Actuating Pin	38	P064615	Locking Block
03	*P064510	Bolt Assembly Kit	39	P064618	Lock Insert (not shown)
04	P064512	Bolt Cover Plate	40	P064624	Magazine Assembly
05	P064515	Bolt Cover Pin	41	P064628	Magazine Tube Outer
06	P064520	Butt Plate	42	P064630	Magazine Tube Retaining Screw
07	P064524	Butt Plate Screws			
08	P064528	Butt Stock Grade I	43	*P064634	Mainspring
09	P064529	Butt Stock Grade II	44	*P064638	Mainspring Follower
10	P064532	Carrier	45	*P064642	Mainspring Guide
11	P064533	Carrier Guide Pin	46	P064645	Mainspring Guide Pin
12	P064535	Carrier Pin	47	P064650	Muzzle Clamp
13	*P064538	Carrier Spacer (not shown)	48	P064653	Muzzle Clamp Screw
14	P064540	Carrier Spring	49	†*P064658	Receiver with Fitted Barrel, Grade I
15	*P064545	Cocking Lever Grade I			
16	*P064546	Cocking Lever Grade II			
17	P064548	Cocking Lever Pin	50	†*P064659	Receiver with Fitted Barrel, Grade II
18	P064551	Cocking Lever Stop Screw			
19	P064555	Cocking Lever Link	51	*P064660	Sear
20	P064558	Cocking Lever Link Pin	52	*P064663	Sear Link
21	P064562	Ejector	53	P064664	Sear Link Pin
22	P064565	Ejector Pin	54	P064665	Sear Link Spring
23	P064568	Ejector Spring	55	P064667	Sear Pin
24	P064570	Extractor	56	P064675	Sight Front
25	P064573	Extractor Plunger	57	P064679	Rear Sight Tension Spring (not shown)
26	P064576	Extractor Spring			
27	P064580	Firing Pin	58	P064680	Sight Assembly Rear
28	P064583	Firing Pin Retaining Pin	59	P064682	Stock Bolt
29	P064586	Firing Pin Spring	60	P064684	Stock Bolt Lock Washer
30	P064590	Forearm Grade I	61	P064686	Stock Bolt Washer
31	P064591	Forearm Grade II	62	P064690	Take Down Screw Grade I
32	P064594	Forearm Band	63	P064691	Take Down Screw Grade II
33	P064597	Forearm Band Pin	64	*P064692	Trigger Grade I
34	*P064600	Frame	65	*P064693	Trigger Grade II
35	P064602	Frame Insert Pin	66	P064695	Trigger Pin
36	*P064610	Hammer Assembly with Guide and Pin	67	P064696	Trigger and Sear Spring

*Indicates part must be fitted by Browning Service Department or qualified gunsmith.

†Part may be purchased by holders of current valid Federal Firearms License.

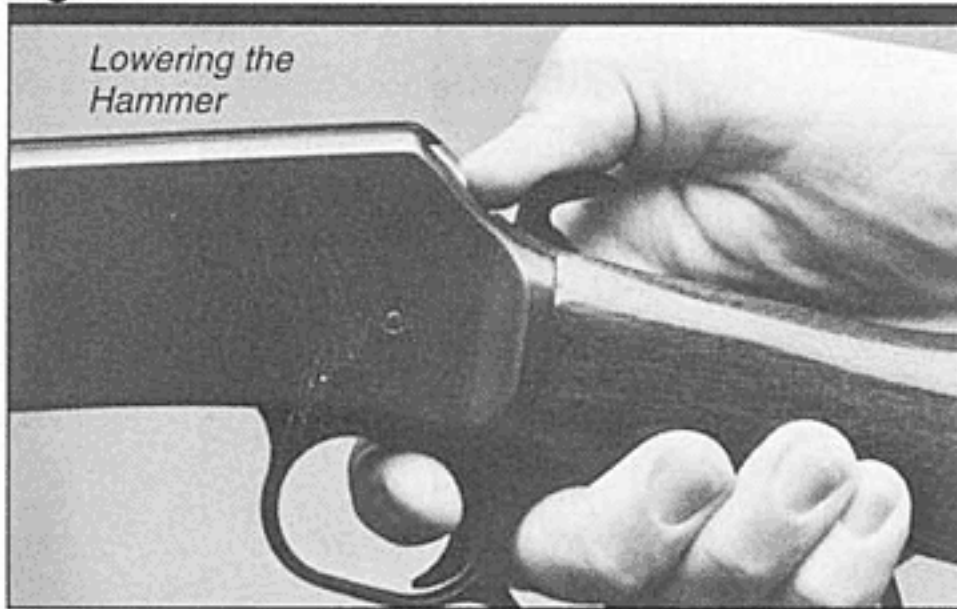
Figure 6

is mounted on the rifle, it is necessary to insert the point of the thumb more from the side. A little practice with an empty rifle will enable a person to become quite adept at using the thumb in this manner.

If a cartridge has already been chambered, you need only thumb the hammer back to its full cock position to prepare the rifle for firing. Otherwise,

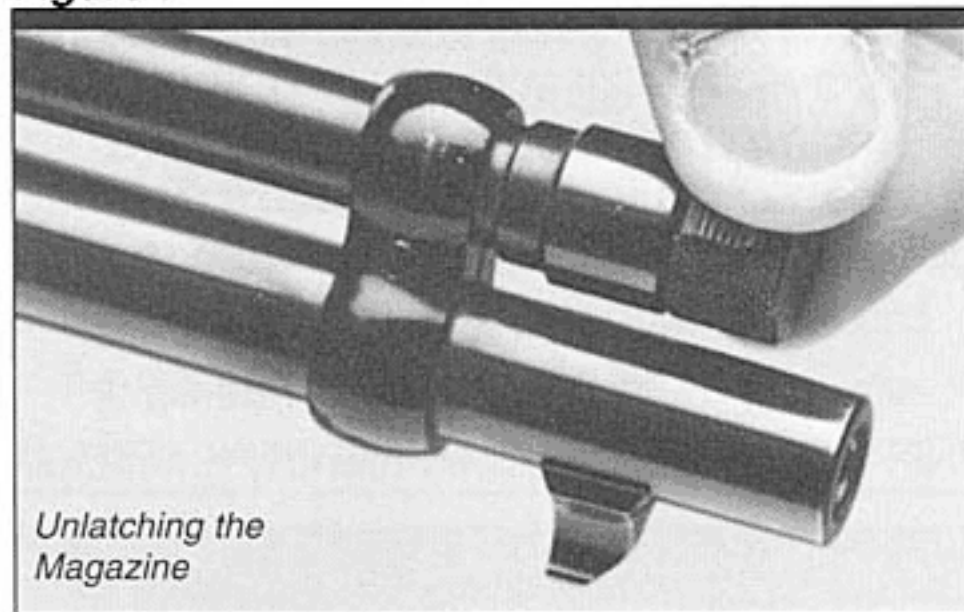
Figure 7

operate the lever in the usual manner to cock the rifle and feed a cartridge from the magazine into the chamber.

CAUTION! DO NOT USE A HAMMER EXTENSION (HAMMER SPUR). ITS USE CAN RESULT IN A MALFUNCTION AND POSSIBLY CREATE A HAZARDOUS CONDITION.

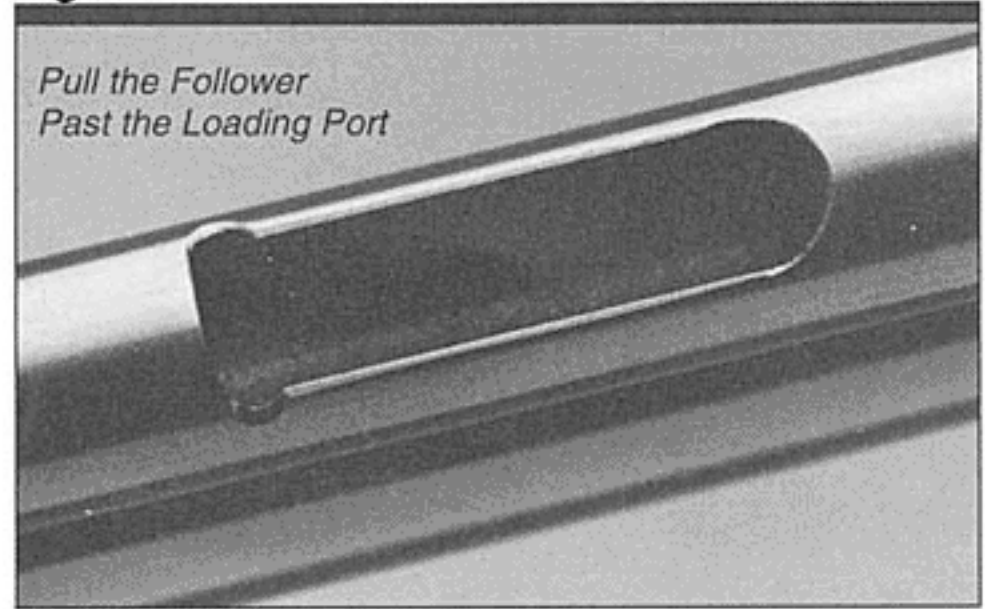
Figure 8

Loading the Rifle

The Browning BL-22 utilizes a tubular magazine positioned directly under the barrel. The capacity of the magazine is:

.22 Long Rifle	15 rounds,
.22 Long	17 rounds,
.22 Short	22 rounds.

With a cartridge in the chamber, total rifle capacity is one more than the magazine capacity listed above.

- 1 To ready the rifle for loading, **FIRST CHECK THE CHAMBER AND MAGAZINE TO BE SURE THEY ARE UNLOADED** and, place the hammer in its dropped position.
- 2 Next, hold the rifle upside down at its balance point with one hand and **BE SURE THE MUZZLE IS POINTING IN A SAFE DIRECTION**. Grasp the knurled end of the magazine assembly with the thumb and forefinger of the opposite hand (see Figure 7).
- 3 Depress the latch and pull the magazine assembly in the direction the muzzle is pointing, until the cartridge follower at the rear end of the assembly clears the loading port in the outer magazine tube (see Figure 8).
- 4 Next, raise the muzzle slightly, but not so high that the magazine slides back down the tube and blocks the loading port. Insert the cartridges into the loading port, allowing them to

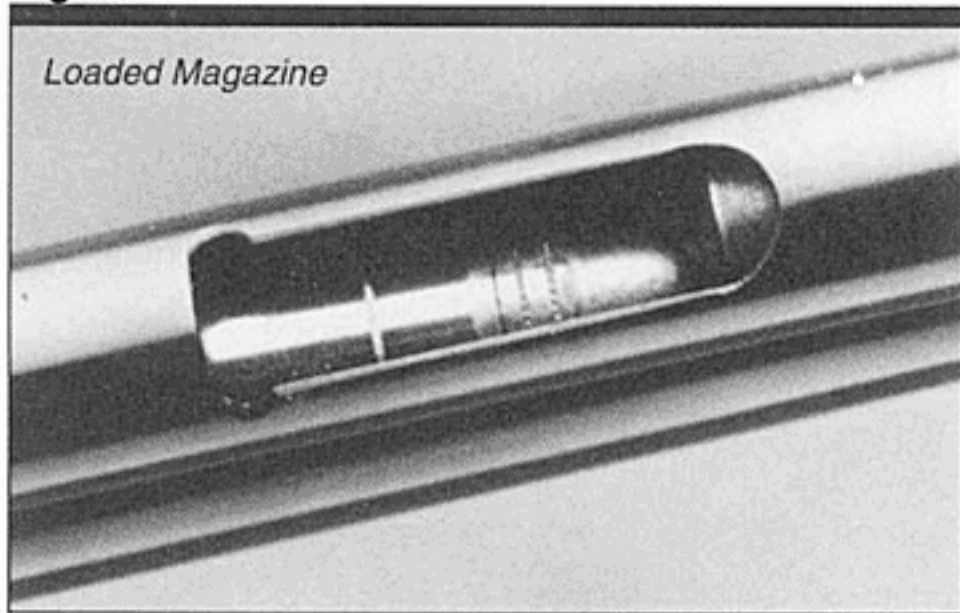
Figure 9

slide toward the receiver until a round is visible in the loading port (see Figure 9). The magazine is then loaded to full capacity.

- 5 Reinsert the magazine assembly until it locks in place. To ready the rifle for firing, first **POINT THE MUZZLE IN A SAFE DIRECTION**, then cycle the action, chambering a round. **CAUTION: THE RIFLE IS NOW LOADED AND WILL FIRE WITH A PULL ON THE TRIGGER. IMMEDI-**

ATELY LOWER THE HAMMER TO THE DROPPED POSITION as described in the previous section, "Operation of the Hammer."

Single Round Loading

To load a single round follow the loading procedure described above, but insert only one round in the magazine.

Unloading Without Firing

Always be certain the muzzle is pointed in a safe direction when unloading the rifle. There are two ways to unload unfired rounds from a BL-22.

UNLOADING USING THE LEVER — To unload the chamber and magazine merely work the lever back and forth until all cartridges have been individually ejected. **CAUTION: ALWAYS WORK THE LEVER SEVERAL TIMES AFTER THE LAST UNFIRED CARTRIDGE HAS BEEN DELIVERED THROUGH THE EJECTION OPENING TO MAKE SURE NO CARTRIDGE IS LEFT IN THE CHAMBER OR MAGAZINE.** Visually check, holding the action

open, to make sure the chamber is empty and that there are no cartridges in the magazine.

UNLOADING FROM THE MAGAZINE — The other way to unload is to operate the lever to draw the breech bolt rearward, ejecting the round in the chamber, and then keep the bolt open and the lever down. With the bolt kept open, hold the rifle upside down at the balance point with either hand and keep the muzzle elevated slightly and pointed in a safe direction. Next, remove the magazine assembly by pulling it completely out of the outer magazine tube and place it under the arm that is holding the rifle, or in another convenient place for safe keeping. Then, simply lower the muzzle of the rifle and empty the cartridges.

CAUTION: THE LAST CARTRIDGE WILL NOT SLIDE OUT OF THE MAGAZINE, BUT WILL BE HELD IN POSITION FOR CHAMBERING. BE SURE TO UNLOAD THIS LAST ROUND BY CYCLING THE BOLT.

Reinsert the magazine assembly until it locks into place. With the rifle pointed in a safe direction, **CYCLE THE ACTION** several times and visually inspect the rifle with the action open, to be certain the chamber and magazine are empty.

Sight Adjustment

The BL-22 lever action rifle is provided with an adjustable folding rear sight. The rifle comes from the factory with sights set for a distance of 50 yards. For greater distances the adjustable leaf of the rear sight must be raised.

White graduation marks are etched into the body of the sight to assist zeroing or sighting-in processes. One graduation moves the point of impact approximately two inches at 50 yards.

ALWAYS UNLOAD YOUR RIFLE BEFORE MAKING ANY ADJUSTMENT TO THE SIGHTS.

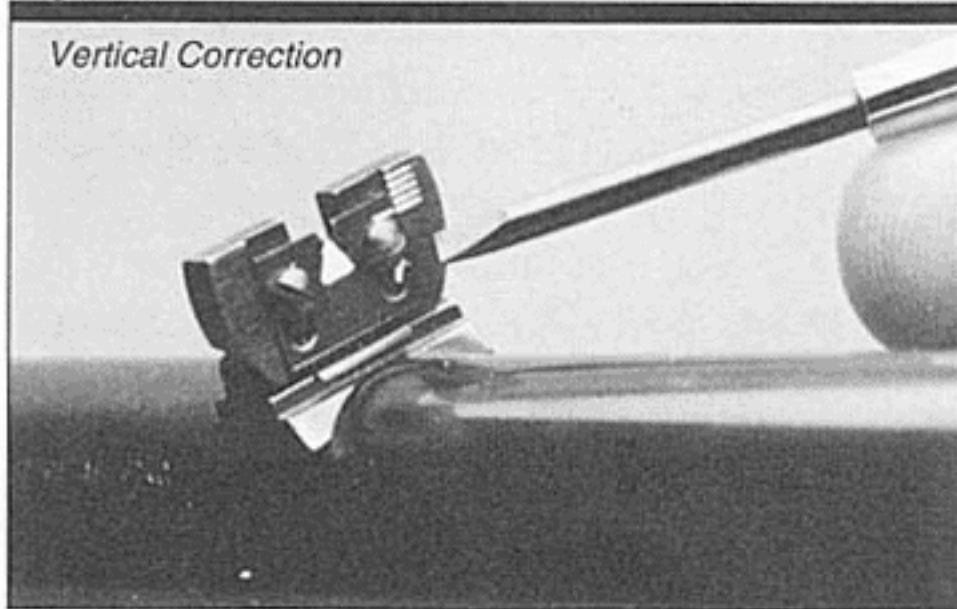
Figure 10

VERTICAL CORRECTION — To adjust the rear sight for vertical correction loosen the two small locking screws in the face of the sight with a fine blade screwdriver. (See Figure 10). Next, move the plate with the "U" shaped notch up or down, as desired. Then, lock the two screws lightly, but firmly. To raise the the point of impact the plate should be raised. To lower the point of impact the plate should be lowered.

ADJUSTING FOR WINDAGE — Lateral adjustment should be correct at the time you purchase your gun. However, if a change ever appears necessary, a lateral adjustment may be accomplished by moving either the front or rear sight to the right or left. Each of these sights is secured to the barrel in dovetail slots. By tapping the sight at its base, it can be moved in the direction desired. A wood dowel or comparable nonmetallic material should bear against the sight during tapping to avoid marring the finish (see Figure 11).

In making the horizontal adjustment, keep this simple rule in mind: The rear sight should be moved the same direction you wish the point of bullet impact to move; the front sight should be moved in the opposite direction you wish the point of the bullet impact to move. Horizontal adjustment is a process of trial and error using the method above. Fortunately, it is seldom necessary.

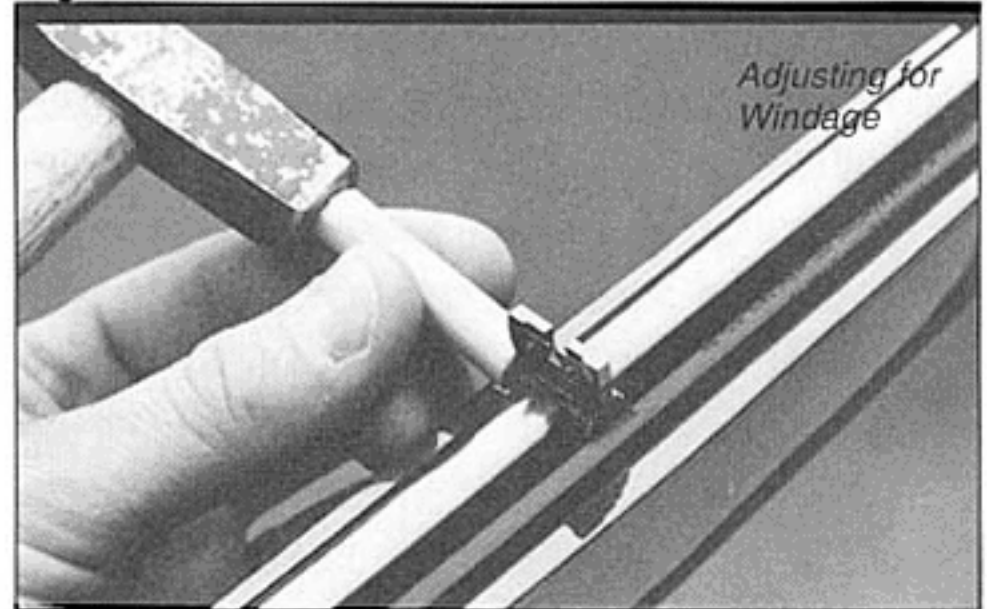
Figure 11

Scope Mounting

The receiver of the BL-22 is grooved to accept most groove or tip-off type scope mounts and receiver sights. These mounts are available for 3/4" or 1" scopes.

Trigger

The trigger mechanism has been adjusted at the factory to provide a short, clean, crisp pull. No attempt should ever be made to alter this trigger pull by anyone other than a Recommended Browning Firearms Service Center or Browning's Service Department in Arnold, Missouri. The trigger is of the two stage design for added safety.

Care and Cleaning

ALWAYS BE CERTAIN THE MAGAZINE AND CHAMBER ARE EMPTY. See page 10 for instructions on unloading your rifle. The rifle should be cleaned within a reasonable time period after shooting. We recommend the following procedure:

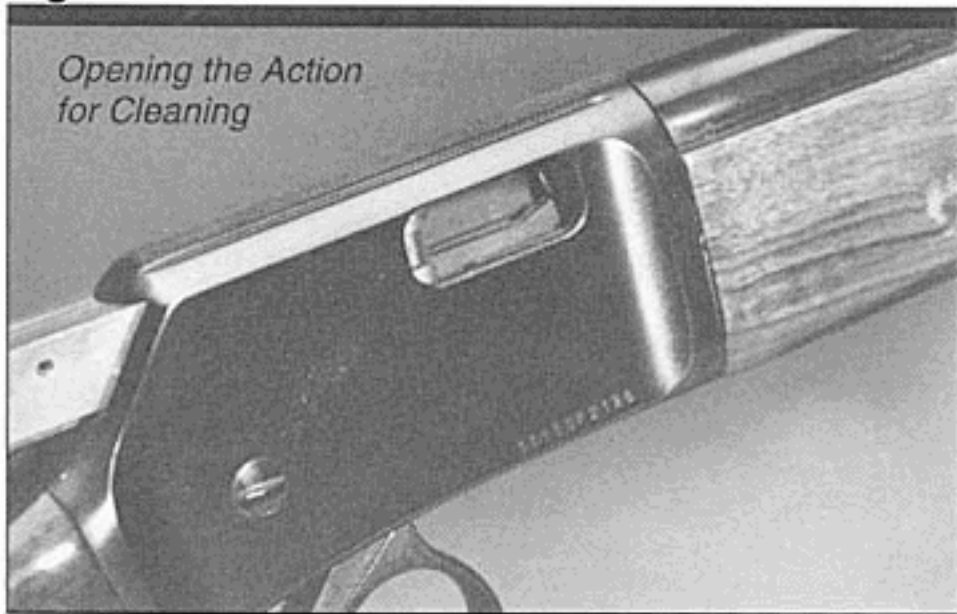
Figure 12

- 1 **OPEN THE ACTION VIA THE LEVER.** It may be necessary to raise the lever about 5° to lower the carrier below the chamber to accommodate cleaning (see Figure 12).
- 2 **USE A 22 RIFLE ROD AND PROPERLY SIZED PATCH SATURATED WITH A GOOD BRAND OF BORE CLEANER.** Insert the rod and patch in the barrel and run it back and forth several

times. Caution should be taken that the rod or handle does not strike the crown of the muzzle as damage to this area can affect the accuracy of the rifle. During the barrel cleaning procedure, place the breech bolt in its open position to allow the end of the rod and patch to go completely through the bore and partly into the receiver.

- 3 **INSPECT THE CHAMBER AND BORE FOR POWDER AND/OR LEAD FOULING.** If any remaining powder or lead fouling cannot be removed by repeating step 2 above, it may be necessary to use a 22 caliber brass bore brush. Dip the brush in any good quality bore solvent and scrub the chamber and bore until the fouling is removed. To prevent brass bristles from breaking off, the brush should be pushed completely through the bore before being withdrawn.

After fouling has been removed, the bore should be wiped dry and then a patch, lightly oiled with a gun oil like Browning Oil, should be run through for protection.

- 4 **THE BOLT, MAGAZINE TUBE AND INTERIOR OF THE RECEIVER SHOULD BE WIPED OFF** as well as possible with a clean rag. Any dried oil in these areas should be removed. Follow this cleaning with a very light film of oil on the affected parts. Do not pour large quantities of oil into the action (an excess of oil will run into the wood and cause it to soften or warp). Browning Oil aerosol is ideal for this light oiling.
- 5 **WIPE OFF EXPOSED METAL SURFACES WITH AN OILED CLOTH,** making sure to wipe the gun clean of all finger marks where moisture will accumulate. Ordinary good judgment will, of course, indicate that the metal of the gun should receive a light film of oil any time the
- gun has been exposed to bad weather or excessive handling.
- 6 **THE WOOD SURFACES CAN ALSO BE WIPED LIGHTLY WITH BROWNING OIL** or polished with any quality furniture wax, but not both.
- 7 The cleaning suggestions recommended above should be all that is necessary. **FURTHER DIS-ASSEMBLY IS NOT RECOMMENDED.**

Service or Repair

If your firearm should require service or repairs, we suggest you first contact a local recommended Browning Firearms Service Center. Contact your Browning sporting goods dealer or call our Service Department for the address of the Service Center nearest you. Otherwise, you may send your firearm directly to our own Service Department. For technical questions about your firearm or service call our Service Department.

***Browning Service Department
3005 Arnold Tenbrook Road
Arnold, Missouri 63010-9406
Phone: 1-800-322-4626***

Canadian Customers call or write:

***Browning Canada Sports Ltd./Ltee,
5617 Chemin St-Francois
St-Laurent, Quebec H4S 1W6
Phone: (514) 333-7261***

When returning your firearm for servicing, you *must* do the following:

- a. Be sure it is completely unloaded.
- b. Package it securely in a cardboard container.
- c. Enclose a letter with your firearm that clearly describes the trouble experienced and the repairs or alterations desired.
- d. If convenient, send a copy of the letter to us separately.
- e. Never return ammunition with your firearm. It is against postal and most commerce regulations.

If you have any questions about this manual or about any other Browning products, call or write our Consumer Information Department:

***Browning Consumer Information
Morgan, Utah 84050
Phone: (801) 876-2711***