

ARMALITE

AR-18 (AR-180)

OPERATION & MAINTENANCE MANUAL

- * General Data
- * Accessories
- * Special Tools
- * Operation--Usual & Unusual Conditions
- * Telescopic Sight
- * Repair
- * Cleaning
- * Preventative Maintenance
- * Trouble Shooting
- * Disassembly/Assembly
- * Replacement of Parts

Armalite, Inc.
118 East 16th Street
Costa Mesa, California

OPERATING AND MAINTENANCE MANUAL

RIFLE, 5.56 - MM, AR - 18

**Armalite, Inc.
118 East 16th Street
Costa Mesa, California**

TABLE OF CONTENTS

CHAPTER	Page
I INTRODUCTION	1 - 1
SECTION 1	
1 - 1. General	1 - 1
1 - 2. Scope	1 - 1
SECTION 2	
1 - 3. Description and Data	1 - 1
1 - 4. Description	1 - 1
SECTION 3	
1 - 10. Tabulated Data	1 - 1
SECTION 4	
1 - 12. Accessories	1 - 3
1 - 15. Special Tools	1 - 3
II OPERATING INSTRUCTIONS	2 - 1
SECTION 1	
2 - 1. Service Upon Receipt of Materials	2 - 1
2 - 6. Services	2 - 1
2 - 9. Bipod	2 - 1
SECTION 2	
2 - 12. Controls	2 - 1
SECTION 3	
2 - 14. Operation Under Usual Conditions	2 - 2
2 - 16. Preparation for Firing	2 - 2
2 - 18. Clean and Lubricate Bolt Carrier Group	2 - 2
2 - 19. Loading	2 - 2
2 - 22. Firing	2 - 3
2 - 27. Stoppage and Immediate Action Procedures	2 - 3
2 - 31. Unloading	2 - 4
SECTION 4	
2 - 33. Operation Under Unusual Conditions	2 - 5
SECTION 5	
2 - 36. Telescopic Sight	2 - 6
2 - 40. Installation	2 - 6
2 - 42. Maintenance	2 - 6
III ORGANIZATIONAL MAINTENANCE INSTRUCTIONS	3 - 1
SECTION 1	
3 - 1. Repair Parts, Tools and Equipment	3 - 1
SECTION 2	
3 - 8. Cleaning and Lubricating after Firing	3 - 1
3 - 9. Cleaning and Lubricating the Barrel	3 - 1
3 - 10. Cleaning and Lubricating Bolt Carrier Group	3 - 2
3 - 11. Cleaning and Lubricating Lower Receiver Group	3 - 2
SECTION 3	
3 - 12. Preventive Maintenance Services	3 - 2
SECTION 4	
3 - 14. Trouble Shooting	3 - 2
SECTION 5	
3 - 16. Maintenance of Rifle	3 - 3
3 - 17. Disassembly/Assembly	3 - 3
3 - 18. Cleaning, Inspection and Repair	3 - 7
3 - 21. Replacement of Parts	3 - 7
3 - 23. Function of Check	3 - 7

LIST OF ILLUSTRATIONS

Number	Title	Page
1 - 1	Rifle, 5.56-MM, AR-18, right and left side views.....	iii
1 - 2	Rifle, 5.56-MM, AR-18, stock folded, left and right side view	iii
1 - 3	Bayonet and Scabbard, Bipod and case, Small Arms Cleaning Rod and Brush	1 - 4
2 - 1	Clearing Rifle	2 - 1
2 - 2	Front Sight Adjustment	2 - 2
2 - 3	Rear Sight Adjustment	2 - 2
2 - 4	Removal of Bolt Carrier	2 - 4
2 - 5	Selector Lever Operation with Stock Folded	2 - 4
2 - 6	Rifle, 5.56-MM, AR-18 in Jump Position	2 - 4
2 - 7	Launching Grenade	2 - 5
2 - 8	Bayonet	2 - 5
2 - 9	Bipod Installation	2 - 5
2 - 10	Telescopic Sight	2 - 6
3 - 1	Rifle, 5.56-MM AR-18 Major Groups (Bolt Carrier Group, Upper Receiver Group, Lower Receiver Group)	3 - 4
3 - 2	Remove/Install Operating Rod Assembly	3 - 4
3 - 3	Remove/Install Hammer Pin	3 - 4
3 - 4	Remove/Install Hammer and Hammer Spring	3 - 4
3 - 5	Disengage/Remove Selector Lever	3 - 4
3 - 6	Remove/Install Trigger Pin	3 - 5
3 - 7	Remove/Install Trigger	3 - 5
3 - 8	Disengage/Engage Takedown	3 - 5
3 - 9	Withdraw/Insert Charging Handle	3 - 5
3 - 10	Remove/Install Bolt Carrier, Guide Rods and Guide Rod Springs	3 - 5
3 - 11	Remove/Install Upper Hand Guard	3 - 5
3 - 12	Remove/Install Firing Pin Retaining Pin	3 - 6
3 - 13	Remove/Install Firing Pin Retaining Pin	3 - 6
3 - 14	Remove/Install Firing Pin	3 - 6
3 - 15	Remove/Install Bolt Cam Pin	3 - 6
3 - 16	Remove/Install Extractor (a) Bolt Assembly (b).....	3 - 6
3 - 17	Bolt Carrier Group Parts	3 - 8
3 - 18	Disengage/Engage Receiver Pivot Pin	3 - 8
3 - 19	Disassemble/Assemble Magazine	3 - 8
3 - 20	Cleaning & Lubricating Bolt Carrier Group	3 - 8
1	Upper Receiver Group	4 - 2
2	Bolt Carrier Group	4 - 4
3	Lower Receiver Group	4 - 6

LIST OF TABLES

Number	Title	Page
1 - 1	Accessories	1 - 2
1 - 2	Special Tools	1 - 3
3 - 1	Trouble Shooting	3 - 3
3 - 2	Preventive Maintenance & Services, Operator	3 - 9
3 - 3	Preventive Maintenance & Services, Organization	3 - 9
3 - 4	Inspection	3 - 10

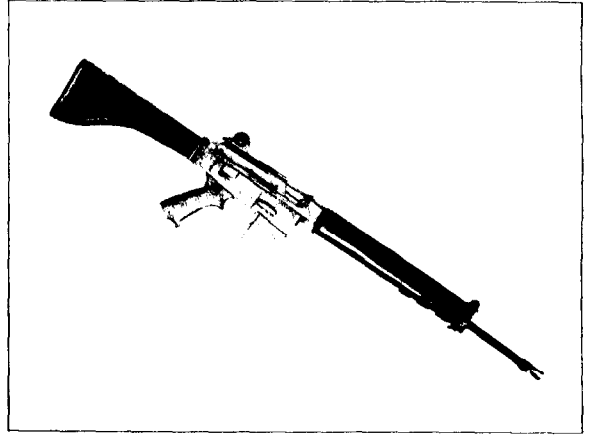
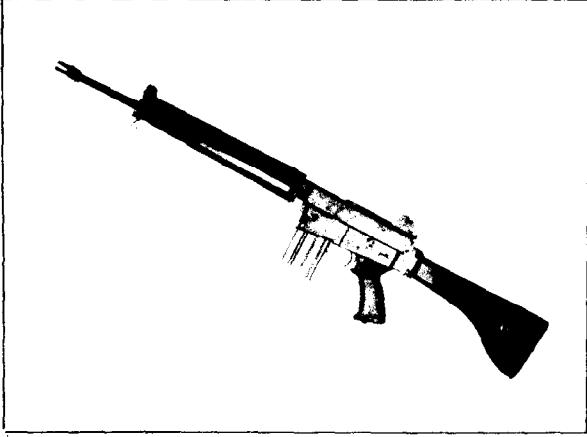

Rifle 5.56 m.m. — AR-18
Figure 1-1

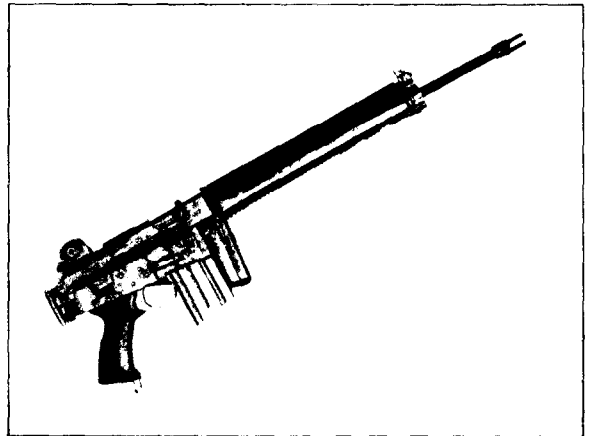
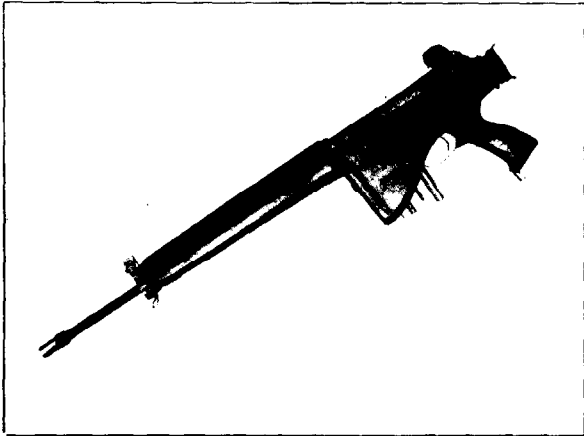

Rifle 5.56 m.m. AR-18 Stock Folded
Figure 1-2

CHAPTER I

INTRODUCTION

Section 1

1-1. GENERAL.

1-2. SCOPE. This manual is published for the information and guidance of personnel responsible for operation and organizational maintenance of the Rifle, 5.56 MM, AR-18. Information provided includes: tabulated data, accessories and special tools, preparation for use, operating instructions, preventive maintenance and lubrication procedures, inspection, trouble-shooting, repair parts, procedures on disassembly, cleaning, repair, assembly and ammunition.

Section 2

1-3. DESCRIPTION AND DATA.

1-4. DESCRIPTION. The AR-18 rifle, (Figure 1-1), is light-weight, air-cooled, gas-operated, magazine-fed, shoulder or hip fired, and designed for either full automatic or semi-automatic fire. The rifle utilizes a 20-round magazine.

1-5. The manufacturer's name, serial number and caliber is stamped on the left side of the upper receiver.

1-6. The barrel is air-cooled and is provided with a flash suppressor and recoil compensator, which serves as a grenade launcher and front support for the bayonet. The barrel is surrounded by a heat resisting fiberglass material, which serves as a hand guard and forearm. The hand guard has a heat resisting metal inner shield. The front sight is adjustable for elevation and the rear sight for windage.

1-7. The rifle has a folding buttstock. (Figure 1-2). The buttstock is made of a durable, synthetic material of high impact strength unaffected by exposure.

1-8. The rifle is readily opened by pressing the guide spring plate forward, providing ready access for removal of the bolt carrier assembly and upper hand guard. Also accessibility to all other working parts for convenient cleaning and inspection. If ever required, the manual charging handle provides a means of forcing the bolt forward to full lock position.

1-9. The bolt incorporates seven locking lugs. Upon closing, the bolt rotates to engage seven similar locking lugs in the barrel extension. Thus, the full force of the explosion of the cartridge is absorbed by the barrel extension and bolt. No pressure is exerted upon the receiver. The receiver is made of light-weight steel stampings. The design contributes to a high degree of safety, durability and performance of the rifle. Portability and logistical value is greatly increased due to resultant weight saving.

Section 3

1-10. TABULATED DATA.

1-11. Tabulated data pertaining to the general characteristics and performance are listed as follows:

Weight

AR-18 Rifle without magazine and sling.....	6.6 lb.
Sling M14 lb.
Empty Aluminum magazine.....	.2 lb.
Loaded Aluminum magazine.....	.7 lb.
AR-18 Rifle with sling and loaded magazine.....	7.4 lb.
Bipod M-36 lb.
Bipod Case2 lb.
Bayonet-Knife M76 lb.
Scabbard M8A13 lb.

Length	
Rifle with flash suppressor-compensator.....	38 in.
Rifle with bayonet-knife.....	43.5 in.
Barrel.....	18 in.
Barrel with flash suppressor.....	19.8 in.
Mechanical Features	
Rifling, R.H. 6 grooves — 1 turn in 12"	
Bore Maximum.....	.2190
Groove Maximum.....	.2235
Sight Radius.....	19.5 in.
Trigger pull	
Maximum.....	8.5 lbs.
Minimum.....	5.0 lbs.
Method of Operation.....	Gas
Type of Mechanism.....	Rotating Bolt
Method of Feeding — Magazine.....	20 rds.
Cooling.....	Air
Ammunition	
Caliber.....	5.56-mm
Type.....	Ball, Tracer & Grenade Launching (Blank)
Firing Characteristics	
Muzzle Velocity (Average).....	3250 fps
Muzzle Energy.....	1300 ft-lb.
Chamber Pressure.....	52,000 psi
Cyclic Rate of Fire.....	700/800 rds. per minute
Maximum Rate of Fire	
Semiautomatic.....	45/65 rds. per minute
Automatic.....	150/200 rds. per minute
Sustained Rate of Fire.....	12/15 rds. per minute
Maximum Range.....	2653 meters
Maximum Effective Range.....	460 meters

Table 1-1. ACCESSORIES

Item	Identifying Number	Figure Number
Bayonet-Knife AR-18	2862	1-3
Bipod, Rifle AR-18	2773.5	1-3
Case, Bipod	2864	1-3
Scabbard, Bayonet-Knife AR-18	2863	1-3

Table 1-2. SPECIAL TOOLS

Item	Identifying Number	Figure Number
Rod, cleaning, small arms, AR-18	2866	1-3
Brush, cleaning, small arms	2867	1-3

Section 4

1-12. ACCESSORIES AND SPECIAL TOOLS.

1-13. ACCESSORIES.

1-14. Accessories are tabulated in Table 1-1 and listed in Appendix I, which is the authority for requisitioning replacements.

1-15. Special Tools.

1-16. Special Tools are tabulated in Table 1-2 and listed in Appendix I, which is the authority for requisitioning replacements.

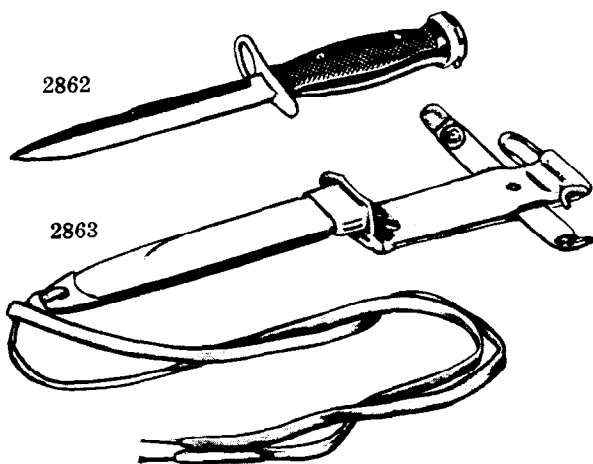

Bayonet-Knife AR-18 and Bayonet-Scabbard, Bayonet-Knife AR-18

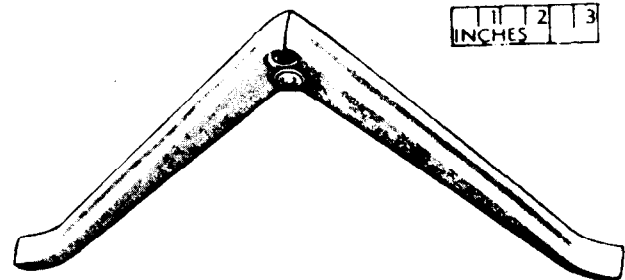

Rifle Bipod, AR-18 2773-5

BRUSH AND SWAB SECTION TO BE INSTALLED ON SMALL ROD SECTIONS BEFORE INSERTION IN POCKET.

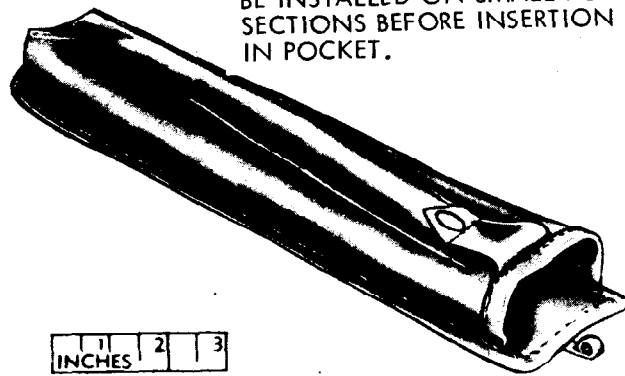

Bipod Case - 2864

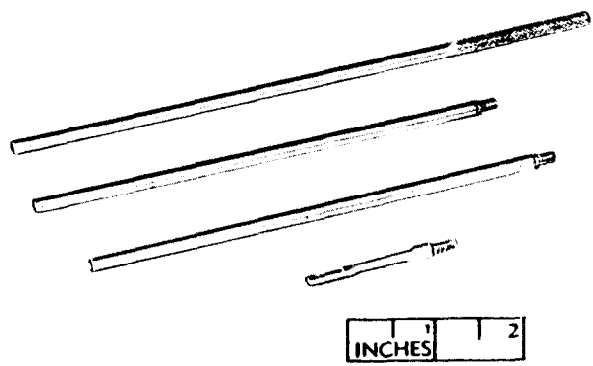

Small Arms Cleaning Rod - 2866

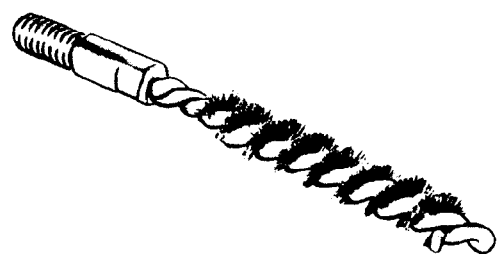

Small Arms Cleaning Brush - 2867

CHAPTER II OPERATING INSTRUCTIONS

Section 1

2-1. SERVICE UPON RECEIPT OF MATERIAL.

2-2. GENERAL.

2-3. Upon receipt of the rifle, it will be inspected by the responsible individual to determine that it has not been damaged in-transit and is in proper condition for service.

2-4. All basic issue items, replacement parts, tools, and equipment checked as invoiced.

2-5. A record will be made of all missing parts, tools, and equipment and any other deficiencies in the shipment. Corrective action will be initiated by the responsible individual.

2-6. SERVICES.

2-7. The rifle will be unpacked, all foreign matter removed from the surfaces of the weapon, assuring all components are clean. If necessary, the bore will be wiped clean by pushing clean, dry patches through the barrel, from the chamber to the muzzle.

2-8. The rifle will be visually inspected for function to include proper seating of the magazine.

2-9. BIPOD.

2-10. Foreign matter will be removed from the bipod and case, as necessary.

2-11. The bipod will be attached to the rifle to assure that the bipod is undamaged, suitable for use.

Section 2

2-12. CONTROLS.

2-13. Refer to (Figure 2-1) for Controls and Operation of Controls.



Remove Magazine



Figure 2-1

Clearing Rifle, Inspect Chamber



Place Selector Lever in Safe Position

Section 3

2-14. OPERATION UNDER USUAL CONDITIONS.

2-15. GENERAL.

2-16. PREPARATION FOR FIRING. Clear the rifle by performing the following operations: Remove magazine, inspect chamber and place selector lever on "safe" position. (Fig. 2-1.)

2-17. SERVICE BEFORE FIRING. Refer to Tables 3-2 and 3-3.

2-18. CLEAN AND LUBRICATE THE BOLT CARRIER GROUP. The bolt carrier group may be removed, as shown in (Figure 3-10.) Remove any oil or dirt from the external surfaces of the bolt and bolt carrier with a clean, dry rag or cleaning patches. Place a drop of oil in each of the two holes of the bolt carrier to lubricate the guide rods and a drop on the body of the bolt. Use oil sparingly, as excess oil may collect foreign matter. Wipe any excess oil from the surface of the bolt carrier. A light film of grease or oil may be applied to the guide rail for the bolt carrier on the left inside of the upper receiver.

2-19. LOADING. *Note*: Repeat Operation in (Figure 2-1). (Safety Procedure).

2-20. LOADING THE MAGAZINE. The magazine has a capacity of 20 rounds and may be loaded with any amount up to that capacity. The magazine follower has a raised portion generally resembling the outline of a cartridge. Cartridges are loaded into the magazine so that the tips of the bullets point in the same direction as the raised portion of the follower.

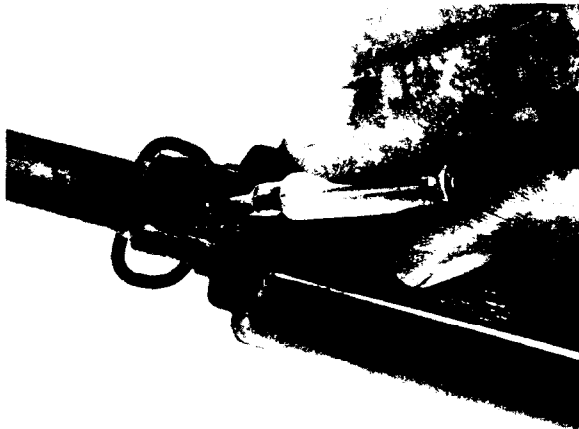

Front Sight Adjustment
Figure 2-2

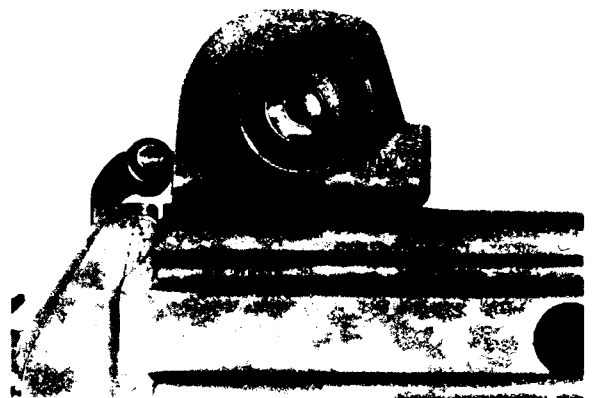

Rear Sight Adjustment
Figure 2-3

2-21. LOADING THE RIFLE. The magazine may be inserted with the bolt and the bolt carrier open or closed. Hold the forearm of the rifle with the left hand, pointing the muzzle in a safe direction. With the right hand, insert a loaded magazine into the magazine housing. Push upwards until the magazine gauge engages and holds the magazine. Rap base of magazine sharply with heel of hand to assure positive retention. Check by attempting to withdraw the magazine without use of the magazine release. If the action is open, grasp the charging handle with the right hand, pull to the rear, thus disengaging the bolt stop and release the charging handle. A round will be stripped from the magazine and loaded into the chamber. If the action is closed when the magazine is inserted, pull the charging handle fully to the rear with the right hand and release it. *NOTE*: Do not "ride" the charging handle forward. If the charging handle is eased forward from the open position, the bolt may fail to rotate and fully lock. If the bolt fails to go all the way forward, push forward on the manual charging handle. The rifle is now loaded, ready to fire.

WARNING

Make sure the selector lever is on the "safe" position, if not ready to fire.

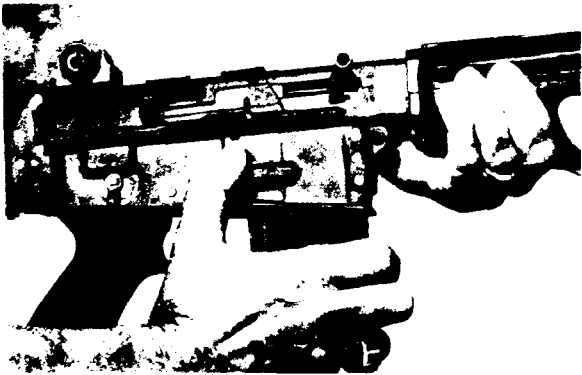

Remove Magazine



Inspect Chamber

Figure 2-4



Disengage Takedown



Remove Bolt Handle

2-22. FIRING.

2-23. SELECTOR LEVER. The rifle may be fired semi-automatically or fully automatically by moving the selector lever to the appropriate position, described in Figures 2-1 and 2-5.

2-24. SEMI POSITION. With the selector lever in this position, the rifle will fire one round each time the trigger is pulled.

2-25. AUTO POSITION. With the selector lever in this position, the rifle will continue to fire until the magazine is empty or the trigger is released. When the rifle is fired on either SEMI or AUTO, the bolt will lock in open position when the last round from a magazine has been fired.

2-26. WITH STOCK FOLDED. With the stock folded, the rifle may be fired and readily controlled from the hip position. The selector lever must be positioned from the right side of the rifle, as the folded stock prevents access to the lever on the left side. See Figure 2-5.

2-27. IMMEDIATE ACTION PROCEDURES FOR REMOVING A LIVE ROUND IN CASE OF FAILURE TO FIRE.

2-28. To apply immediate action, follow the sequence below:

a. Wait 10 seconds, then pull charging handle fully to the rear; observe for ejection of cartridge or cartridge case.

1. If a cartridge is ejected, release charging handle to feed a new round.

2. If a cartridge or case is not ejected, a failure to extract or feed has occurred. Check for round in chamber. If chamber is empty, change magazines, reload and attempt to fire the rifle.

b. If a. 1 above occurs, it may indicate a defective round, a broken firing pin, hammer spring or a bolt closure failure.

c. If a. 2 above occurs, it may indicate a broken extractor.

2-29. MISFIRE, HANG FIRE AND COOK-OFF. In the event of failure of the rifle to fire when the trigger has been pulled and the hammer has fallen, allow ten seconds to elapse in the event of a hang fire and then eject the round and attempt to fire. Cook-off can only result from an excessively heated chamber, caused by full automatic fire requiring approximately 180-200



Figure 2-4 Remove Bolt Assembly, Guide Rods and Springs

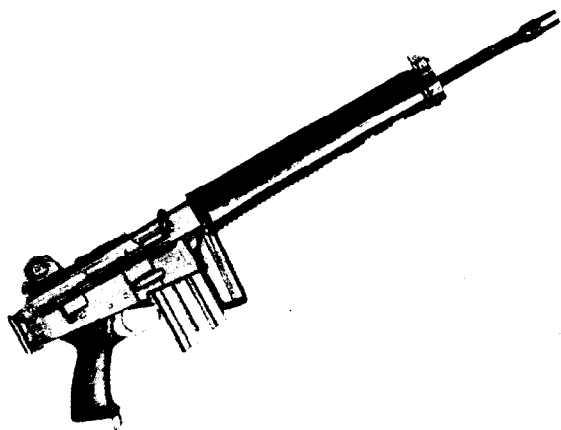

Figure 2-5 Selector Lever Operation with Stock folded

rounds fired in a very minimum period of time. A cook-off can result when the primer is exposed to extremely high temperature, but still will require approximately 30 seconds for the heat to ignite the primer. In the event a cook-off occurs, immediately remove the magazine and eject the chambered cartridge. Under all above conditions, be particularly careful as to the direction the rifle is pointed.

2-30. **DOUBLE FEED.** Double feed may occur when initially loading the rifle, caused by failure to allow the first round to fully chamber and pulling the charging handle to the rear with the first cartridge still held by the extractor. The bolt carrier, going forward, will attempt to strip the second round from the magazine, resulting in a jammed condition. Remove the magazine and pull the charging handle to the rear, releasing the first cartridge.

2-31. **UNLOADING.** Repeat operation in figure 2-1 and 2-16.

2-32. **INSTALLING ACCESSORIES,** figures 2-8 and 2-9.



Rifle 5.56 m.m., AR-18, Stock Folded in Jump Position
Figure 2-6A



Rifle 5.56 m.m., AR-18, Stock Extended in Jump Position
Figure 2-6B

Section 4

2-33. OPERATION UNDER UNUSUAL CONDITIONS. If it is desired to fire the rifle with the stock folded, the user should become fully familiar with the operation of the selector lever from the right side of the rifle. The forefinger of the right hand should be used to allow the continued proper hold on the pistol grip (a left handed shooter would use the thumb of the left hand).

2-34. The rifle may be attached to the user for jump purposes, with stock folded or fully extended. See figure 2-6.

2-35. The rifle should be held when launching grenades from a hip position, muzzle elevated, utilizing the sling. See figure 2-7.

NOTE

The rifle should never be fired from the shoulder when launching a grenade.



Launching Grenade
Figure 2-7

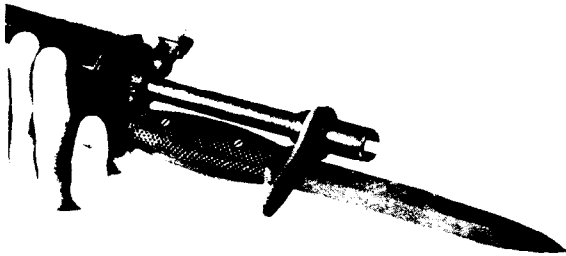

Remove/Install Bayonet-Knife
Figure 2-8

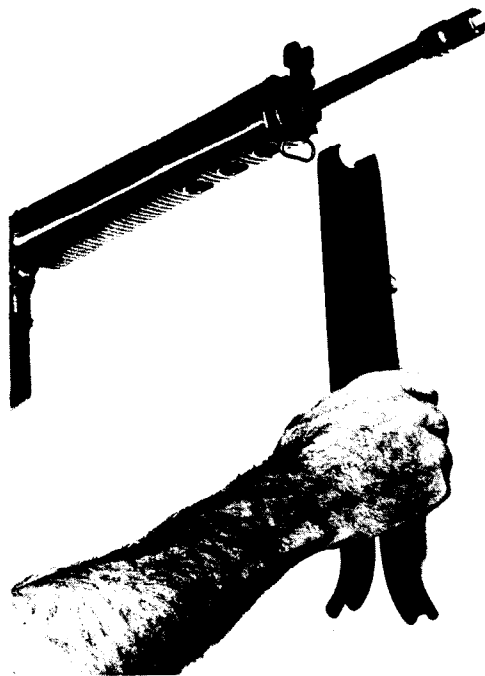

Remove/Install Bipod
Figure 2-9

Section 5

2-36. **TELESCOPIC SIGHT.** Fig. No. 2-10. The telescopic sight is one of extremely durable design with outstanding optical capabilities. It has a true 2.75X magnification.

2-37. The quick detachable mount allows immediate removal or installation. Regardless of the number of times removed, it will return to a positive zero due to the dove tail design of the base and mount. A tunnel over the sight allows use of the iron sight in case of such an immediate requirement.

2-38. A range knob on top of the sight has 4 settings — 1 for 1-200 yards; 1 each for 300, 400 and 500 yards. This rapid and positive elevation system contributes greatly to practical use in the field. The protective cap on the top of the range adjustment knob is removed by the use of the head of a cartridge. Sight elevation adjustments are made under this cap by rotating the elevation knob with the head of a cartridge in the direction of the arrow to move the point of impact up.

2-39. Dust covers are provided and they should be used at all times when the sight is not installed on the rifle or intended for immediate use to protect the lens.

2-40. **INSTALLATION.** The sight is installed by compressing the safety lever on the front of the mount allowing it to clear the dove tail base on the rifle. The plunger at the rear of the mount is pressed firmly against the front base of the rear sight, compressing the spring allowing the scope mount to slide forward on the base.

2-41. The sight incorporates an inverted post as well as fine crosshairs. When "holding over" at extreme ranges, this precludes the post from blotting out the target. This comparatively heavy post allows positive point of aim in times of near darkness when the fine cross hairs tend to disappear against the background.

2-42. **MAINTENANCE.**

1. Use lens cover at all times when the sight is not in use on the rifle.
2. Check periodically to assure all caps and screws are snug and in place.
3. Oil the spring plungers lightly.
4. Oil the base occasionally to facilitate mounting and to prevent rusting.

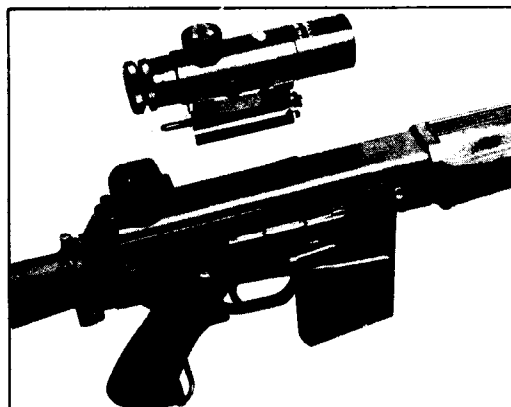

Figure 2-10

CHAPTER III ORGANIZATIONAL MAINTENANCE INSTRUCTIONS

Section 1

3-1. REPAIR PARTS, TOOLS AND EQUIPMENT.

3-2. GENERAL.

3-3. This chapter lists repair parts, common tools and equipment and special tools and equipment.

3-4. REPAIR PARTS (2nd Echelon)

PART NO.	DESCRIPTION	QUANTITY
2666-A	Extractor	29
2671-C	Firing Pin	3
2673-B	Take Down Pin, Bolt	3
2668-A	Spring, Extractor	29
2715-C	Spring, Firing Pin	3
2678-A	Spring, Operating Rod	2

3-5. ACCESSORIES AND SPECIAL TOOLS. Accessories and Special Tools are tabulated in Table 3-4.

Section 2

3-6. LUBRICATION.

3-7. GENERAL. The rifle should be cleaned and lubricated at the end of each day's use, or when exposed to an excessive amount of dirt, grit, or other foreign matter and/or water. The rifle should not generally be fired beyond 200 rounds without being cleaned, although, under normal conditions, the rifle can be expected to perform reliably up to approximately 1,000 rounds without cleaning. For best continued operation, all surfaces should be protected by a very light film of oil, except under sub-zero temperatures all oil should be removed from moving components. The rifle can function completely dry, although lack of lubricant is undesirable, due to resultant excessive wear. NOTE: Keep the gas piston clear of excess oil to prevent early formation of carbon.

3-8. CLEANING AND LUBRICATION AFTER FIRING.

3-9. CLEANING AND LUBRICATING THE BARREL.

a. Attach the wire brush to the cleaning rod, dip in solvent cleaning compound and brush the bore thoroughly. Do not submerge barrel in cleaning solution. The gas piston should not be allowed to fill with oil. Brush the bore from chamber to muzzle, using straight-through strokes.

NOTE

Do not reverse direction of brush while in bore.

Push the brush through the bore until it extends beyond the muzzle. Continue until the bore is well covered with solvent. Remove the brush from the rod, and dry the bore by pushing through clean, dry patches. Continue until patches come out clean and dry.

b. Clean the locking lugs in the barrel extension, just to the rear of the chamber. Brush the lugs with a small brush.

c. After cleaning, lubricate the bore with a lightly oiled patch to prevent corrosion and pitting. Lightly oil the lugs in the barrel extension.

d. Remove the individual component parts of the operating rod. Wipe clean with oil-soaked patches. Use the cleaning rod with the brush to clean the gas piston. Remove any excess oil. See Figure 2-6.

3-10. CLEANING AND LUBRICATING THE BOLT CARRIER GROUP.

- a. Remove the bolt carrier group from the upper receiver. Field strip the bolt carrier group. Wash all external surfaces with a patch saturated in solvent cleaning compound.
- b. Using a small brush dipped in solvent cleaning compound, scrub all carbon deposits and dirt from the locking lugs of the bolt.

CAUTION

Brush the face of the bolt, paying particular attention to area under the face of extractor. Do not attempt to remove discoloration caused by heat.

When dry, lightly oil the surface of the bolt carrier and place one drop on the bolt body. See figure 3-20.

3-11. CLEANING AND LUBRICATING THE LOWER RECEIVER GROUP.

- a. Wipe any particles of dirt from the trigger mechanism with a clean patch or brush.
- b. Place a drop of oil on each of the pins and the stock hinge and release plungers.

Section 3

3-12. PREVENTIVE MAINTENANCE SERVICES.

3-13. GENERAL.

3-14. RESPONSIBILITY. It is the responsibility of the operator to assure his rifle is properly lubricated at all times and is in proper functioning order. If the rifle appears to not be functioning normally, it will be reported to the responsible organizational personnel. (Table 3-1) . It will be the responsibility of organizational maintenance personnel to make minor repairs, as indicated in Table 3-3.

3-15. GENERAL.

3-16. GENERAL PROCEDURES. Organizational maintenance personnel will be responsible for the care and preventive maintenance of the rifle when in temporary storage and/or undergoing routine inspection. These personnel are responsible for assurance that the rifle is being properly maintained by the operator and only re-issued when in proper mechanical condition. Evidence of component failure or wear will be reported to higher authority, consistent with standard operating instructions.

Section 4

3-14. TROUBLESHOOTING.

3-15. SCOPE. The following information is to assist the operator and organizational maintenance personnel to restore inoperative or worn, or damaged equipment to a satisfactory operating condition. This includes both determination of the cause (trouble shooting) and corrective action. All repair maintenance indicated shall be performed only by qualified personnel utilizing standard service equipment. Table 3-1.

Table 3-1. TROUBLE SHOOTING

Malfunction	Probable Cause	Remedy
Bolt fails to lock to the rear after last round.	1. Faulty magazine.	Replace magazine.
Failure to feed.	1. Faulty magazine. 2. Binding bolt and bolt carrier in locked position.	Replace magazine. Disassemble and clean (on a new weapon, one or two drops of oil on the guide rods may remedy this trouble). Check firing pin and spring and oil. Clean and lubricate bolt and carrier, higher echelon.
Failure to fire.	1. Improper assembly of firing pin. 2. Improperly installed hammer or trigger spring. 3. Obstructed chamber.	Reinstall firing pin and check bolt takedown pin for damage. Also check spring and replace if broken. Disassemble and install properly. Clean.
Fires with selector lever on SAFE.	1. Faulty selector lever. 2. Faulty or misaligned trigger pin.	Higher echelon. Replace trigger pin.
With selector lever on SEMI, fires when trigger is released.	1. Faulty or misaligned trigger pin. 2. Faulty hammer or trigger.	Notify higher echelon. Notify higher echelon.
Bolt seizes, will not rotate.	1. Carbon dirty or burred bolt group.	Hold rifle in vertical position and strike butt <i>sharply</i> on ground while pushing down on charging handle. Clean as necessary.

Section 5

3-16. MAINTENANCE OF RIFLE.

3-17. DISASSEMBLY/ASSEMBLY. This section contains instruction on disassembly, assembly and maintenance, before and after firing. For disassembly and assembly instructions, see figures 3-1 thru 3-19.

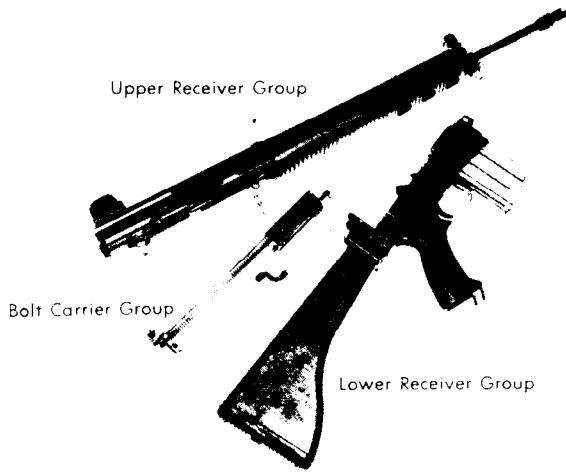

Rifle, 5.56 m.m. AR-18 Major Groups
Figure 3-1

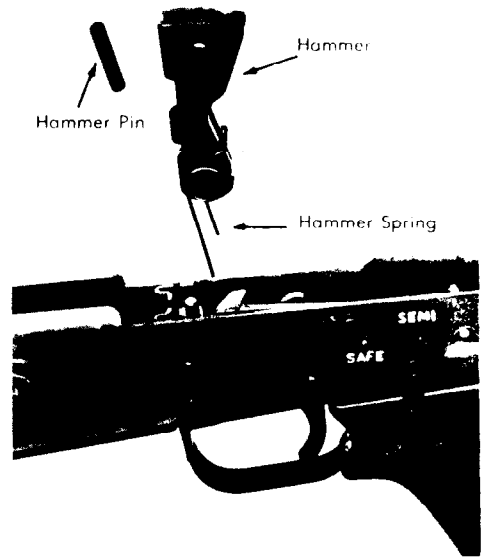

Remove/Install Hammer and Hammer Spring
Figure 3-4

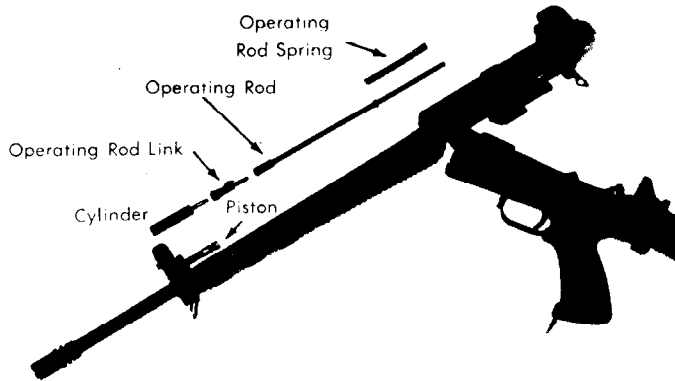

Remove/Install Operating Rod Assembly
Figure 3-2



Disengage/Remove Selector Lever
Figure 3-5A



Remove/Install Hammer Pin
Figure 3-3

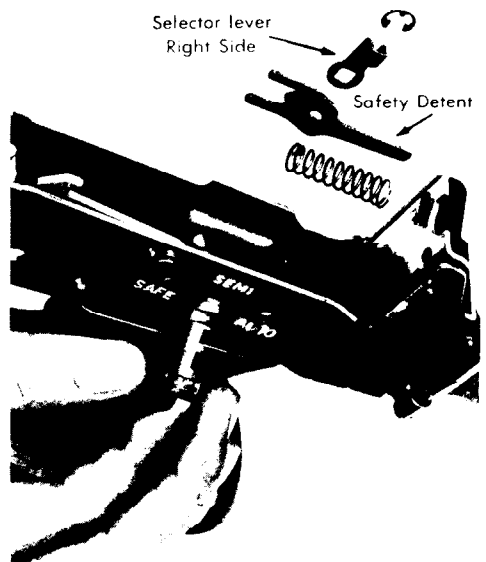

Disengage/Remove Selector Lever
Figure 3-5B



Remove/Install Trigger Pin
Figure 3-6

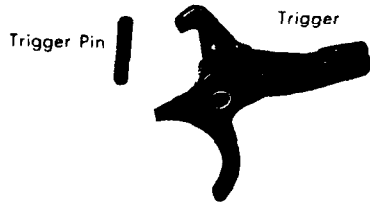

Remove/Install Trigger
Figure 3-7



Disengage/Engage Takedown
Figure 3-8

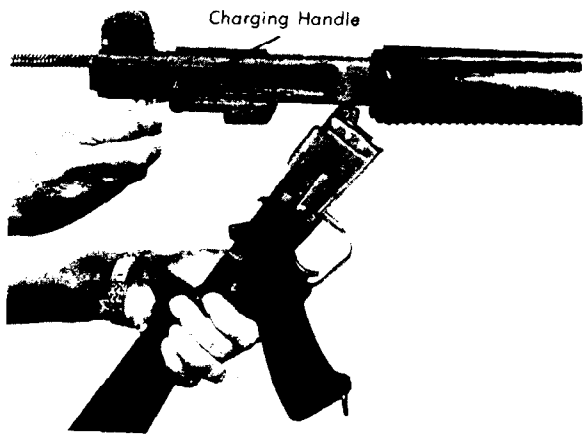

Withdraw/Insert Charging Handle
Figure 3-9

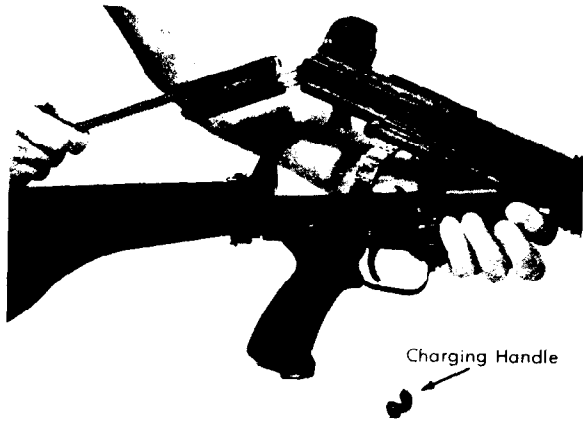

Remove/Install Bolt Carrier, Guide Rods
and Guide Rod Springs
Figure 3-10



Remove/Install Upper Hand Guard
Figure 3-11

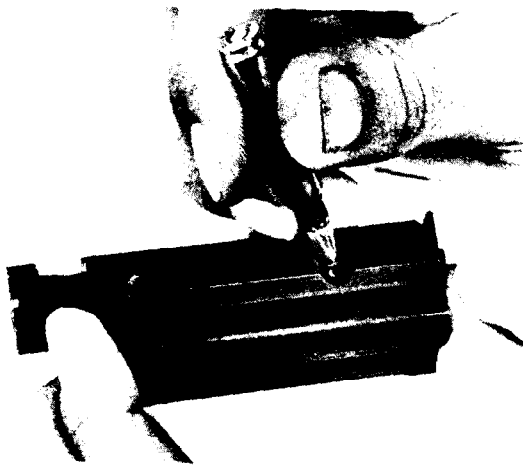

Remove/Install Firing Pin Retaining Pin
Figure 3-12

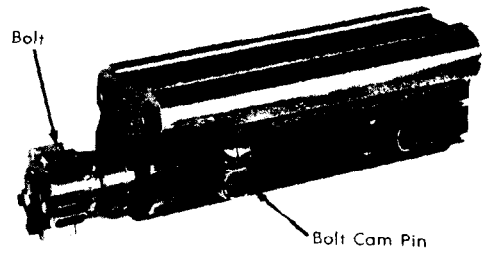

Remove/Install Bolt Cam Pin and Bolt
Figure 3-15

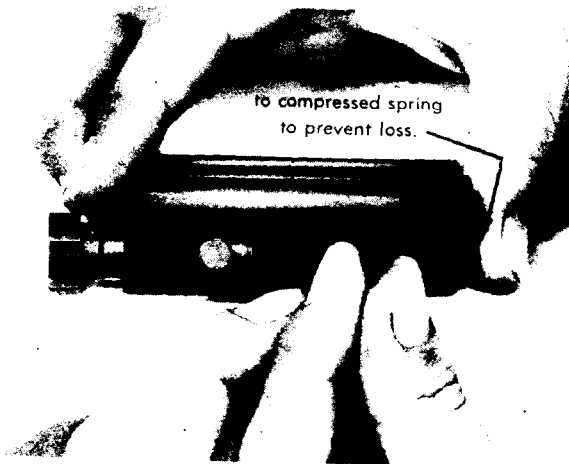

Remove/Install Firing Pin Retaining Pin
Figure 3-13



Remove/Install Extractor
Figure 3-16a

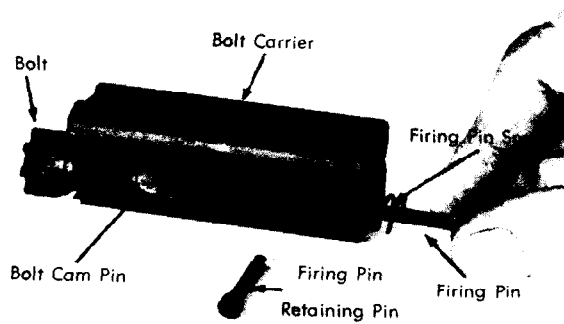

Remove/Install Firing Pin
Figure 3-14

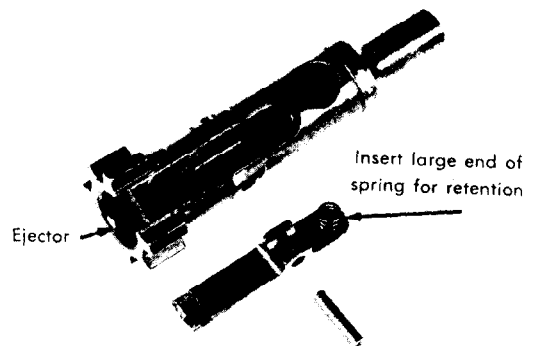

Bolt Assembly
Figure 3-16b

- 3-18. **CLEANING, INSPECTION AND REPAIR.**
- 3-19. **BEFORE FIRING.** The rifle should be inspected as indicated in Section 3, Chapter II, 2-14.
- 3-20. **AFTER FIRING.**
- a. Cleaning after Firing: Table 3-2 and 3-3.
 - b. Inspection after Firing: Table 3-4.
- 3-21. **REPLACEMENT OF PARTS.**
- 3-22. All replacement parts are interchangeable and require no adjustments when being installed in this rifle. However, to insure proper function and full reliability, the following precautions should be taken:
- a. Do not interchange bolts, bolt carriers and barrels. Keep the bolt carrier assembly with its original barrel to assure retention of correct headspace.
 - b. If replacement of either part becomes necessary, carefully check the new part to see that it fits properly and operates smoothly.
- 3-23. **FUNCTION CHECK.**

NOTE

Remove Magazine

3-24. A complete function check of the rifle consists of checking the operation of the rifle while the selector lever is in the **SAFE, SEMI, and AUTO** positions. The following sequence is used for a rapid, complete check. Any portion of the check may be used alone to determine the operational condition of any specific fire selection. Start with the upper and lower receiver groups in the open position.

NOTE

Receiver is in open position

- a. **SAFE** position. Cock hammer and pull trigger. Hammer should not fall.
- b. **SEMI** position. Pull trigger. The hammer should fall. Hold trigger to rear, recock hammer and release trigger. Hammer should transfer from disconnect to the hammer and sear engagement.

NOTE

Receiver is in closed position

- c. **AUTO** position. Pull trigger, hammer should fall. Hold trigger to the rear and operate charging handle, recocking the hammer. Release charging handle. The hammer should fall. Release trigger and operate charging handle, cocking hammer. Release charging handle. Hammer should not fall. For further safety check, while cocked with safety on, rap butt on floor. If hammer falls, turn in for repair.

- d. **SEMI** position. Pull the charging handle to the rear. Inspect the chamber for safety and release charging handle. Pull the trigger. Hammer should fall.

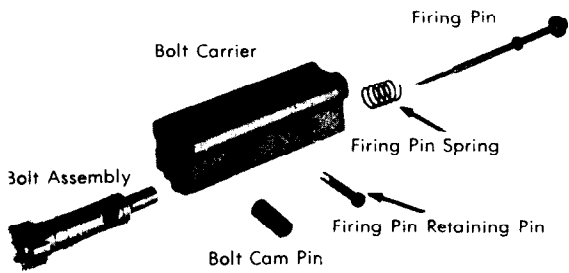

Bolt Carrier Group Parts
Figure 3-17

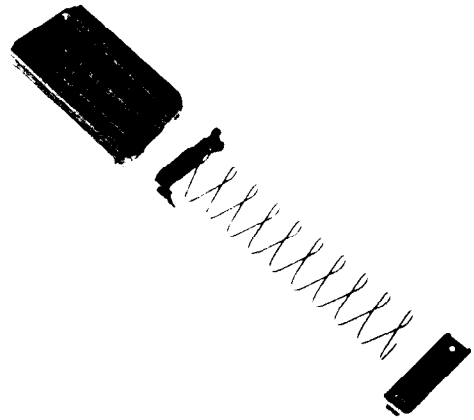

Disassemble/Assemble Magazine
Figure 3-19b



Disengage/Engage Receiving Pivot Pin
Figure 3-18

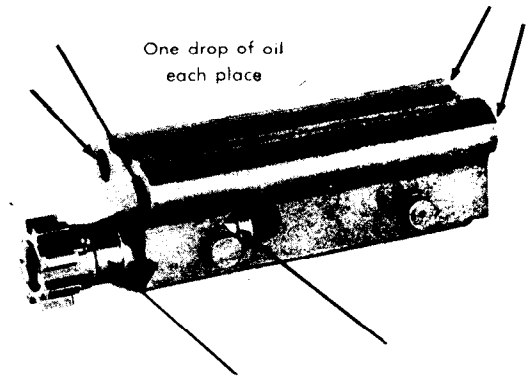

Cleaning and Lubricating the Bolt Carrier Group
Figure 3-20



Disassemble/Assemble Magazine
Figure 3-19a

Table 3-2.

PREVENTIVE MAINTENANCE SERVICES

Interval & Sequence No.			Operator			Daily Schedule
Before Firing	During Firing	After Firing	Item to be Inspected	Procedures	Paragraph References	
1			Barrel Assembly	Wipe oil from bore and chamber.		
2			Bolt Assembly & Barrel	Retract bolt to assure free movement between bolt carrier and receiver.		
3			Rifle	Hand function to assure proper operation.		
4			Lower Receiver & Magazine	Check magazine for positive retention and functioning of bolt catch.		
		5	Barrel, Barrel Extension, Bolt Carrier Assembly	Clean and lubricate. Particular attention to clean bolt carrier and bolt assembly.		

Table 3-3.

PREVENTIVE MAINTENANCE SERVICES

Sequence No.	Organizational Maintenance Personnel		Weekly Schedule	
	Item to be Inspected	Procedures	Paragraph References	
1	Barrel & Bolt Assembly	Inspect for adequate and not excessive lubrication.		
2	Rifle	Hand function to assure proper operation.*		
3	Lower Receiver & Magazine	Check magazine for positive retention & functioning of bolt catch.*		
4	Bolt Assembly	Inspect extractor for cracks. Check extractor spring for proper tension.*		
5	Barrel, Bolt Assembly, Guide Rods, Lower Receiver, Operating Rod	Inspect for cleanliness & Lubrication.* *Prior to issue.		

Table 3-4.

INSPECTION

Part, Components or Area	Instructions
Barrel and Barrel Extension	<p>Inspect surfaces for cracks or defects.</p> <p>Check barrel extension for burrs, broken or worn locking lugs.</p> <p>Inspect bore for damage.</p>
Front Sight & Operating Rod.	<p>Check front sight and operating rod for cracks and general condition.</p>
Upper & Lower Receiver Groups.	<p>Inspect the receivers and all parts for cracks.</p> <p>Inspect all parts for wear or damage.</p> <p>Check springs for condition, straightness and tension.</p>
Bolt and Bolt Carrier.	<p>Check for cracks in bolt.</p> <p>Inspect bolt for condition of locking lugs, pitted or chipped bolt face, and elongated firing pin hole.</p> <p>Inspect firing pin for wear and burrs.</p> <p>Inspect bolt carrier for cracks, burrs and chips.</p> <p>Check socket head cap screws for being staked.</p>

APPENDIX I BASIC ISSUE ITEMS LIST

Section 1

1-1. PREFACE. This appendix list the basic issue items, tools, equipment and replacement parts for rifle, 5.56 mm, AR-18.

Section 2

1-2. BASIC ISSUE ITEMS. The group listings are a breakdown of equipment by a physical description supported by illustrations.

(Figures 1-2-3 exploded views).

1-3. MAJOR ITEMS.

GROUP ASSEMBLY PARTS LIST

Figure & Index No.	Manufacturer Stock No.	Description	Unit of Issue	Quantity Incorporated in Unit	Organizational	15-Day Maint. Allow Per 100 Equipment
UPPER RECEIVER GROUP						
1A*	2632	Assy, Weld & Rivet, Upper Receiver				
2 *	2631	Receiver, Upper		1		
3 *	2680	Housing, Rear Sight		1		
4 *	2580	Extension, Barrel		1		
5 *	2674	Guide Track, Upper Receiver		1		
6	2589	Rivet, Auto Sear	1	1		
7 *	2840	Lug, Front, Dust Cover		1		
8 *	2841	Lug, Rear, Dust Cover		1		
9 *	2785	Plate, Scope Mount		1		
10A	2679	Assy, Barrel To Upper Receiver	1			
11 *	2632	Upper Receiver Weld & Rivet Assy.		1		
12 *	2626	Barrel	1	1		
13A*	2856	Assy, Front Sight	1			
14 *	2634	Front Sight (Factory or Ordnance Installation Only)		1	(1.0)	
15	2776	Swivel Sling, Front Sight	1	1		
16A	2857	Assy, Piston Front Sight				
17	2643	Piston, Front Sight	1	1		
18	2763	Ring, Piston	3	3		
19	2635	Blade, Front Sight	1	1		
20	2636	Plunger, Front Sight	1	1		
21	2677	Spring, Plunger, Front Sight	1	1		
22	2637	Taper Pin, Front Sight	2	2		
23A	2855	Assy, Dust Cover	1			
24A	2845	Weld Assy, Dust Cover	1	1		
25 *	2837	Cover, Dust		1		
26 *	2842	Cam Follower, Dust Cover		1		
27	2844	Spring, Plunger, Dust Cover	1	1		
28	2843	Plunger, Cam Follower, Dust Cover	1	1		
29	2780-1	Roll Pin	1	1		
30	2838	Spring, Hinge Pin, Dust Cover	1	1		

* Indicates part of an assy. not to be ordered separately.

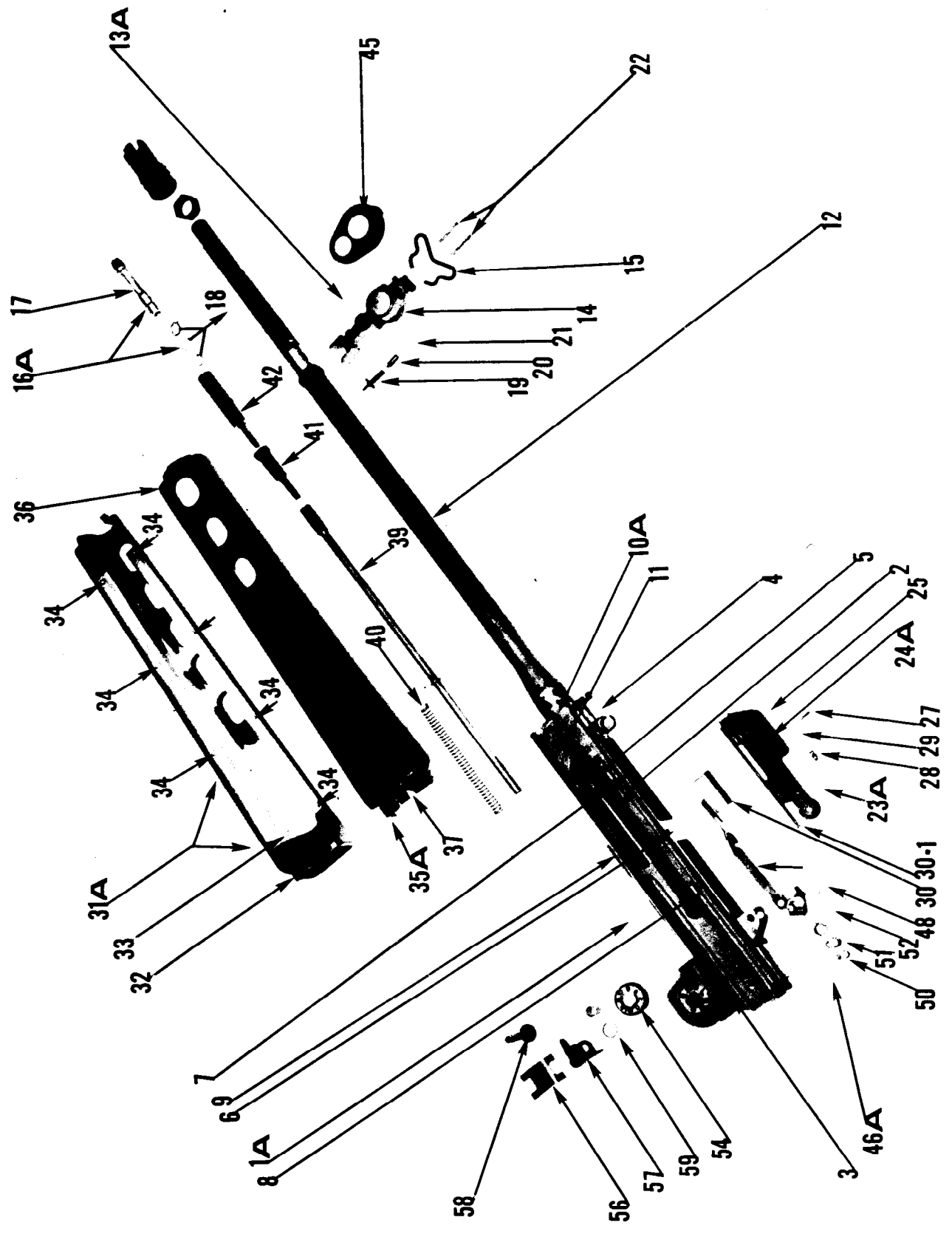

GROUP ASSEMBLY PARTS LIST

Figure & Index No.	Manufacturer Stock No.	Description	Unit of Issue	Quantity Incorporated in Unit	Organizational	15-Day Maint. Allow Per 100 Equipment
30-1	2839	Hinge Pin, Dust Cover	1	1		
31A	2717	Assy, Upper Hand Guard	1			
32 *	2629	Hand Guard Upper		1		
33 *	2663	Liner, Upper Hand Guard		1		
34	2779	Drive Screw	8	8		
35A	2716	Assy, Lower Hand Guard	1			
36 *	2630	Hand Guard, Lower		1		
37 *	2664	Liner, Hand Guard, Upper		1		
38	2779	Drive Screw	8	8		
39	2641	Operating Rod	1	1		
40	2678	Spring, Operating Rod	1	1	(1.0)	
41	2639	Link, Operating Rod	1	1		
42	2642	Cylinder, Operating Rod	1	1		
43	2846	Nut, Recoil Compensator	1	1		
44	2775	Recoil, Compensator	1	1		
45	2644	Cap, Hand Guard	1	1		
46A	2703	Assy, Auto Sear				
47A	2734	Rivet Assy, Auto Sear				
48 *	2587	Sear, Automatic	1	1		
49 *	2654	Extension, Auto Sear	1	1		
50 *	2655	Pivot Pin, Sear Extension	1	1		
51	2656	Bushing, Auto Sear	1	1		
52	2675	Spring, Auto Sear	1	1		
53	2659	Pivot Pin, Auto Sear	1	1		
54	2685	Drum, Windage, Rear Sight	1	1		
55	2676	Spring, Rear Sight	1	1		
56	2682	Spring, Flat, Rear Sight	1	1		
57	2681	Aperature, Rear Sight	1	1		
58	2683	Screw, Windage Rear Sight	1	1		
59	2791	Protector, Rear Sight Screw	1	1		
60	2853-1	Snap Ring, Rear Sight	1	1		
BOLT GROUP						
61A	2705	Assy, Bolt Carrier	1			
62 *	2646	Carrier, Bolt		1		
63 *	2684	Pin, Press Fit, Bolt Carrier		1		
64	2671	Firing, Pin	1	1	(1.0)	
65	2715	Spring, Firing Pin	1	1	(1.0)	
66	2673	Take Down Pin, Bolt	1	1	(1.0)	
67	2590	Pin, Cam	1	1		
68A	2836	Assy, Charging Handle				
69 *	2594	Handle, Charging	1	1		
70 *	2835	Key, Charging Handle		1		
71	2667	Pin, Extractor	1	1	(1.0)	
72	2668	Spring, Extractor	1	1	(1.0)	
73	2666	Extractor	1	1		
74	2780-3	Roll Pin, Ejector	1	1		
75	2669	Ejector	1	1		
76	2670	Spring, Ejector	1	1		
77	2665	Bolt	1	1		

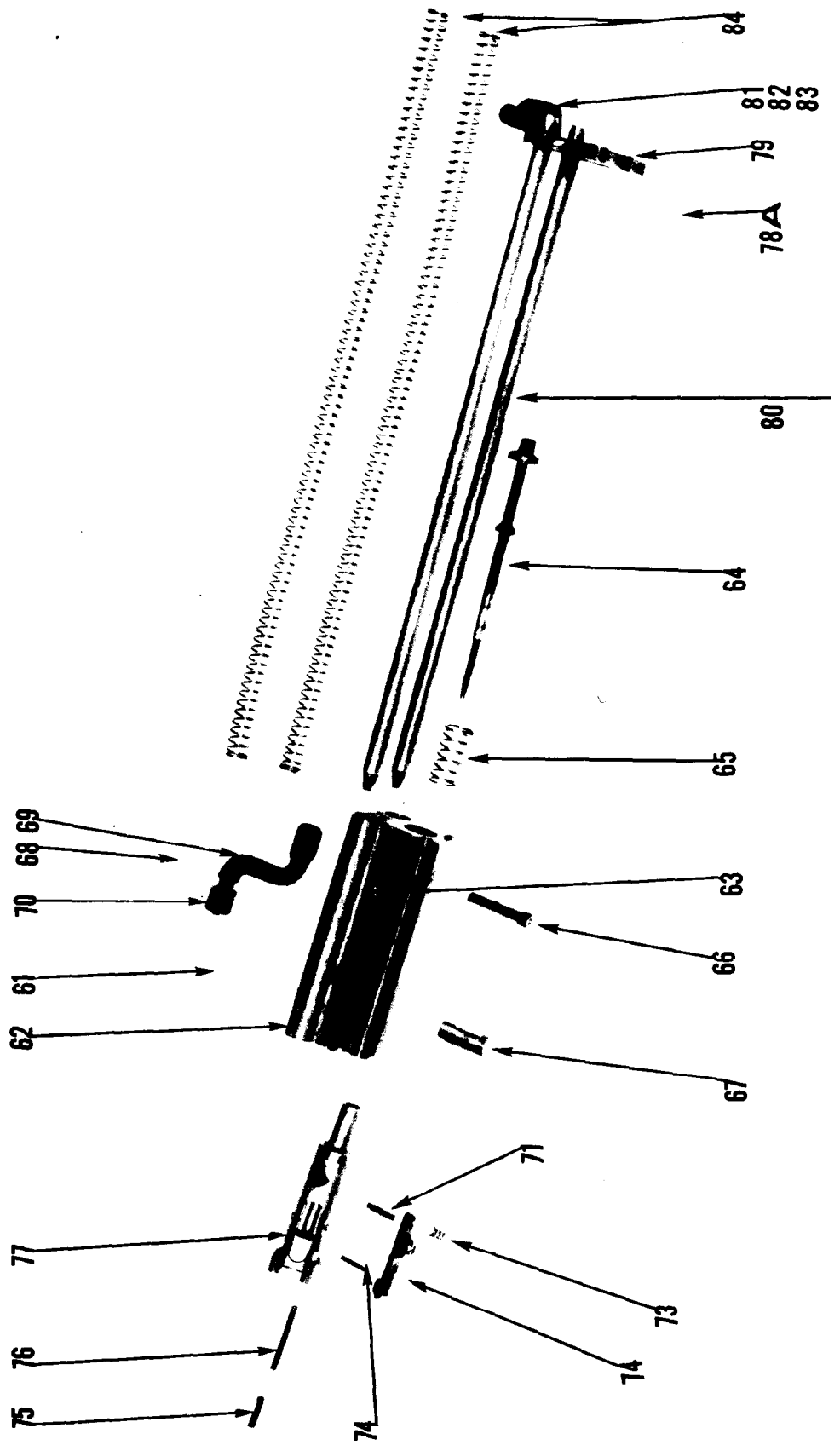

GROUP ASSEMBLY PARTS LIST

Figure & Index No.	Manufacturer Stock No.	Description	Unit of Issue	Quantity Incorporated in Unit	Organizational	15-Day Maint. Allow Per 100 Equipment
78A	2662	Assy, Stake, Guide Rod	1			
79 *	2660	Forging, Plate, Guide Rods		1		
80 *	2661	Guide Rod		2		
81	2764	Plunger, Guide Rod Plate	1	1		
82	2765	Spring, Plunger, Guide Rod Plate	1	1		
83	2780-1	Roll Pin, Plunger, Guide Rod Plate	1	1		
84	2606	Spring, Action	2	2		
LOWER RECEIVER GROUP						
85A	2628	Assy, Weld & Rivet, Lower Receiver	1			
86	2687	Rivet, Trigger Guard		2		
87A*	2858	Weld Assy, Trigger Guard	1			
88 *	2645	Trigger Guard		1		
89 *	2623	Nut, Pistol Grip		1		
90 *	2772-1	Post, Snap, Fastener		1		
91 *	2627	Receiver, Lower		1		
92 *	2782	Bracket, Lower Receiver		1		
93 *	2658	Bracket, Magazine Latch		1		
94 *	2604	Bushing, Bolt Catch		1		
95A*	2753	Weld Assy, Bulkhead				
96 *	2744	Bulkhead, Receiver		1		
97 *	2746	Plate, Bulkhead		1		
98A	2708	Assy, Buttstock	1			
99A*	2859	Assy, Fastener, Buttstock				
100 *	2614	Buttstock		1		
101 *	2772-2	Cover, Snap Fastener		1		
102 *	2772-5	Spacer, Snap Fastener		8		
103 *	2772-4	Spring, Snap Fastener		2		
104 *	2772-3	Plate, Snap Fastener		1		
105 *	2772-6	Rivet, Snap Fastener		4		
106 *	2852-1	Washer, Plain, Snap Fastener		4		
107A	2860	Assy, Buttcap				
108 *	2618	Buttcap		1		
109 *	2621	Recoil Pad		1		
110	2774	Screw, Recoil Pad	2	2		
111A	2752	Weld Assy, Hinge, Buttstock	1			
112 *	2760	Hinge, Buttstock		1		
113 *	2754	Nut, Buttstock Hinge		1		
114	2620	Screw, Buttstock	1	1		
115	2854-1	Snap Ring, Hinge Pin, Stock	1	1		
116A	2861	Assy, Pistol Grip	1			
117 *	2617	Pistol Grip		1		
118 *	2696	Sling, Swivel, Pistol Grip		1		
119	2723	Washer, Plain, Pistol Grip	1	1		
120	2622	Bolt, Pistol Grip	1	1		
121	2780-2	Roll Pin, Plunger, Bulkhead	2	2		
122	2672	Spring, Plunger, Bulkhead	1	1		
123	2761	Plunger, Bulkhead	2	2		
124	2586	Hinge Pin	1	1		
125	2609	Hammer	1	1		
126	2653	Spring, Hammer	1	1		

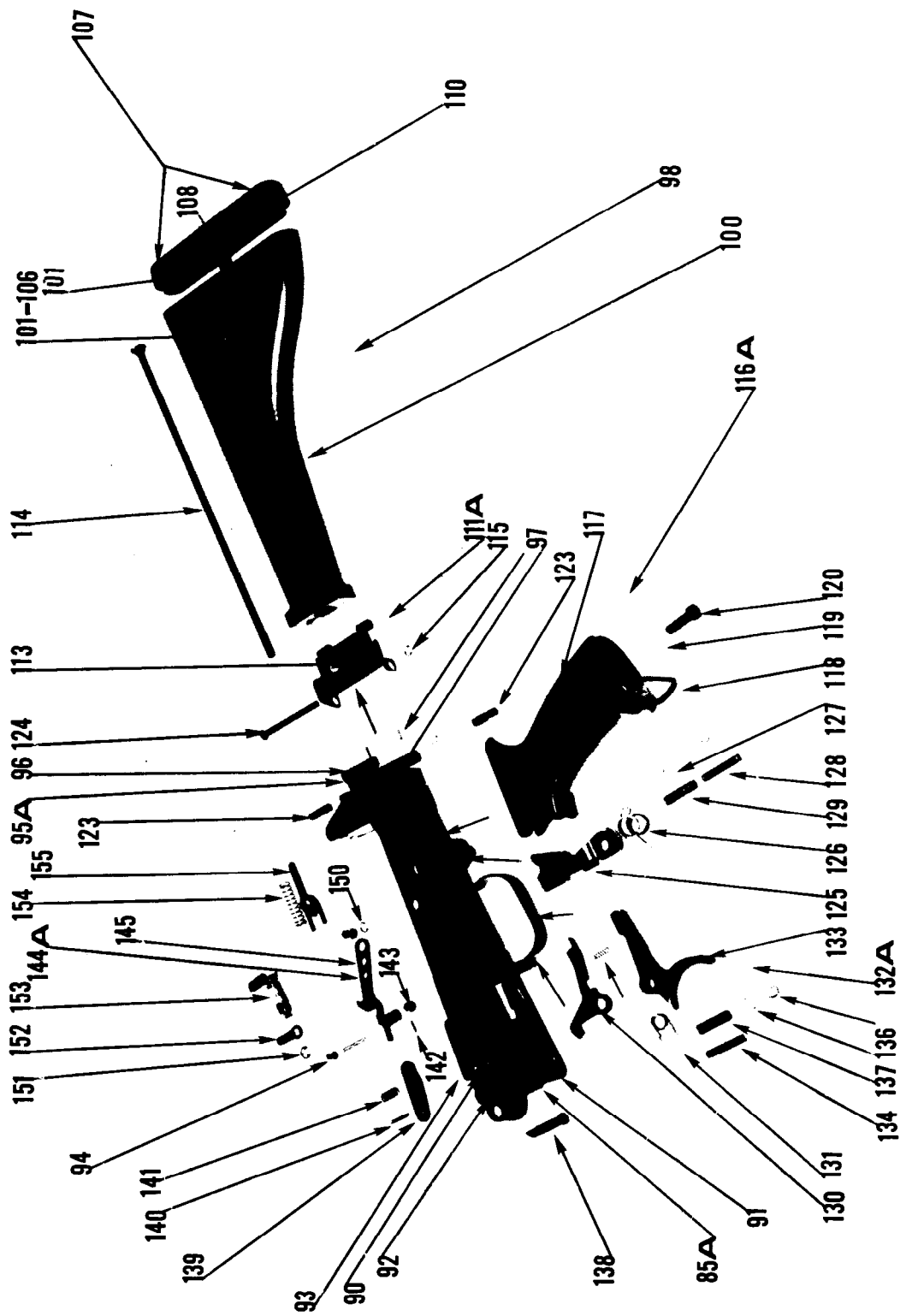

GROUP ASSEMBLY PARTS LIST

Figure & Index No.	Manufacturer Stock No.	Description	Unit of Issue	Quantity Incorporated in Unit	Organizational	15-Day Maint. Allow Per 100 Equipment
127	2651	Snap Ring, Hammer, Trigger	2	2		
128	2650	Pin, Hammer, Trigger	2	2		
129	2610	Bushing, Hammer	1	1		
130	2607	Disconnect, Trigger	1	1		
131	2695	Spring, Disconnect	1	1		
132A	2712	Assy, Riveted, Trigger		1		
133 *	2647	Trigger	1			
134 *	2608	Assy Pin, Trigger	1			
135	2652	Spring, Trigger	1	1		
136	2694	Spacer, Trigger	1	1		
137	2648	Bushing, Trigger	1	1		
138	2781	Takedown Pin, U & L Receivers	1	1		
139	2657	Latch, Magazine	1	1		
140	2780-4	Roll Pin, Magazine Latch	1	1		
141	2702	Spring, Magazine Latch	1	1		
142	2780-2	Roll Pin, Bolt Catch	1	1		
143	2603	Retainer, Spring, Bolt Catch	1	1		
144A	2601	Weld Assy, Bolt Catch		1		
145 *	2597	Bolt Catch	1			
146 *	2599	Housing, Plunger, Bolt Catch	1			
147	2602	Spring, Plunger, Bolt Catch	1	1		
148	2600	Plunger, Bolt Catch	1	1		
149	2605	Pin, Bolt Catch	1	1		
150	2854-4	Snap Ring, Bolt Catch	1	1		
151	2854-1	Snap Ring, Safety Lever	1	1		
152	2768	Lever, Safety	1	1		
153	2595	Casting, Safety	1	1		
154	2701	Spring, Safety Detent	1	1		
155	2598	Detent, Safety	1	1		
ACCESSORIES						
156	2688	Magazine Assy, 20-round			(4.0)	
158	2862	Bayonet-Knife, AR-18				
159	2863	Scabbard, Bayonet-Knife, AR-18				
160	2773-5	Bipod, AR-18				
161	2864	Case, Bipod, AR-18				
162	2865	Scope, 2.75 x 20mm with mount, AR-18				
163	2866	Cleaning Rod, AR-18				
164	2867	Bore Brush, Caliber. 22				
165	2868	Sling, AR-18			(2.0)	