

CHAPTER 5

REPAIR

Section I. CARTRIDGE MAGAZINE

24. Removal

Refer to figure 16 for removal of cartridge magazine.

25. Disassembly

Detailed disassembly of cartridge magazine is not necessary for inspection. If **any part** is unserviceable, replace **maga-**
zine.

26. Cleaning

Refer to paragraph 19 for cleaning.

27. Inspection

Inspect the exterior of magazine (fig. 1'7) for **burs** or other damage. **Check for** spring tension and for the correct assembly of magazine spring.

Note. Small spring loop must be up and to the front.

28. Installation

Refer to figure 16 for installation Of magazine.

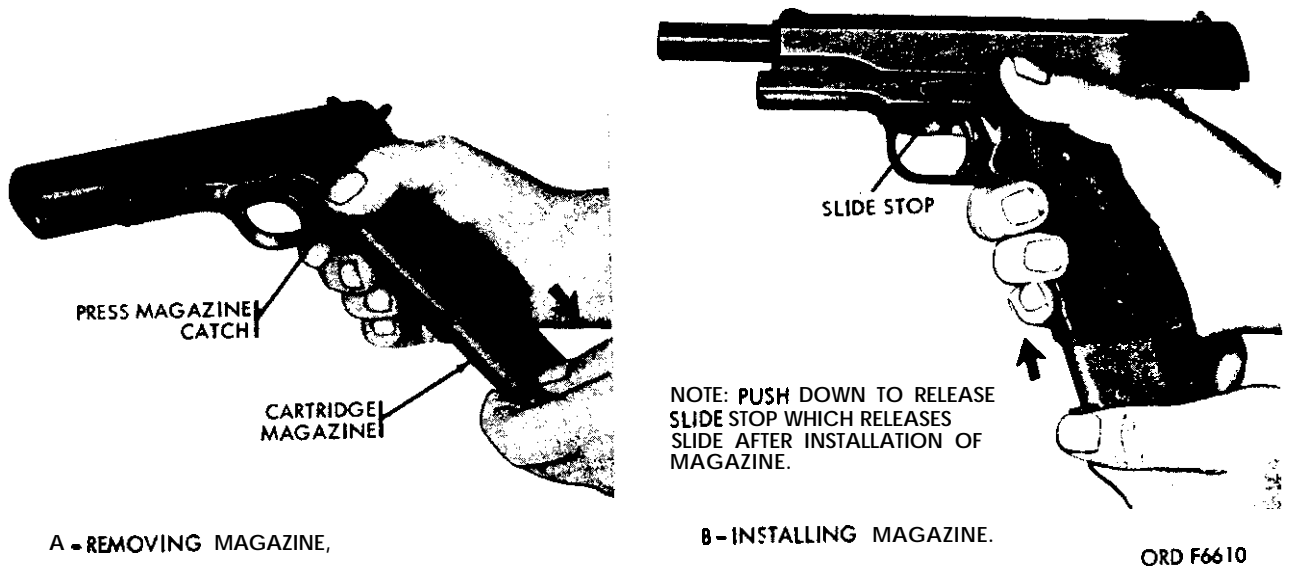

Figure 16. Remove/install cartridge magazine.

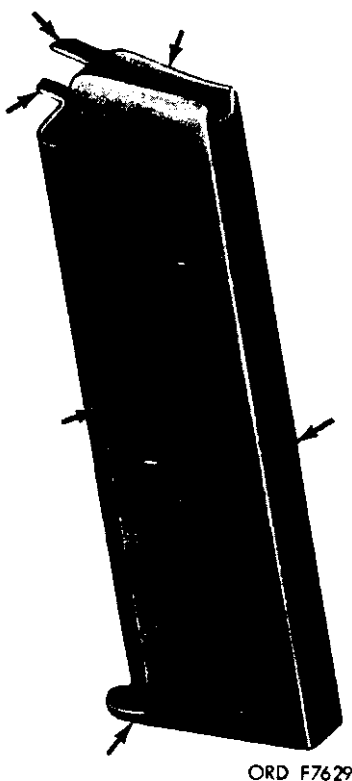

Figure 17. Cartridge magazine inspection points.

Section II. BARREL AND SLIDE GROUP

29. Disassembly

Note. White arrows, shown on illustrations, indicate removal or disassembly and black arrows assembly or installation.

Refer to figures 18 thru 21 for disassembly of barrel and slide group.

Warning: Wherever springs are found to be under tension or pressure, extreme care should be exercised when removing components. Keep the finger and thumb over applicable components to prevent injury to personnel or loss of parts.

30. Cleaning

Refer to paragraph 19 for cleaning.

31. Inspection (fig. 22)

a Inspect the barrel for burrs on the exterior and interior rim of the muzzle. In-

spect the barrel for pitting, bulges, and sharpness of lands (figs. 23 through 25).

b. Barrel must be straight, as determined visually, clean and free of corrosion.

c. Pits in the chamber are allowable if they are not large enough to cause extraction difficulties.

d. Pits as wide as a land or groove and less than three-eighths inch are allowable. Barrels containing pits as indicated in figures 23 thru 25 will be rejected.

e. Scattered or uniformly fine pits or fine pits in a densely pitted area are allowable. Tool marks or scratches are accepted, regardless of length. Tool marks will appear on lines running laterally in the grooves or may run spirally across the top of lands.

f. Definitely ringed bores or bores ringed sufficiently to bulge the outside

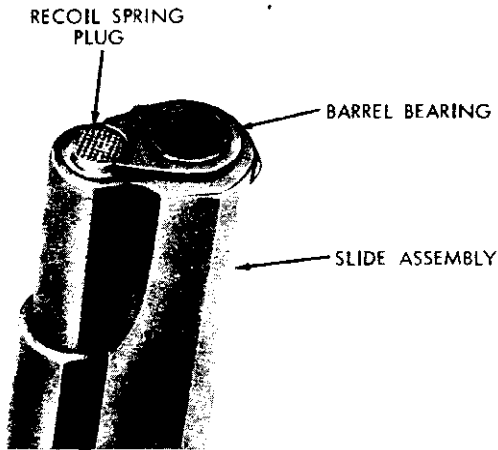

VIEWING MUZZLE END OF PISTOL.

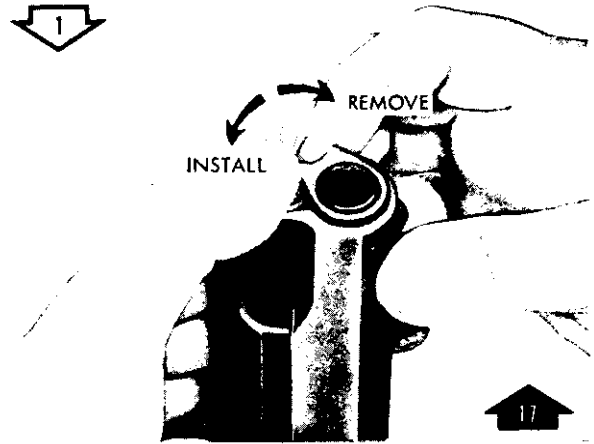

COMPRESS RECOIL SPRING PLUG AND ROTATE BARREL BEARING.

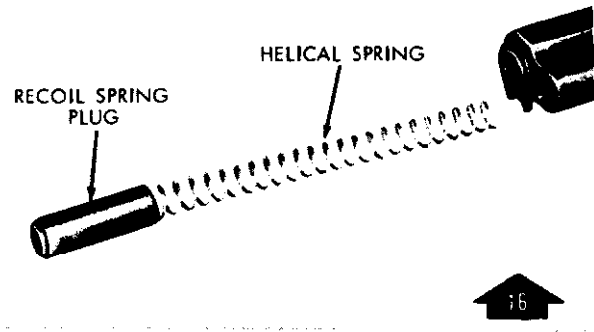
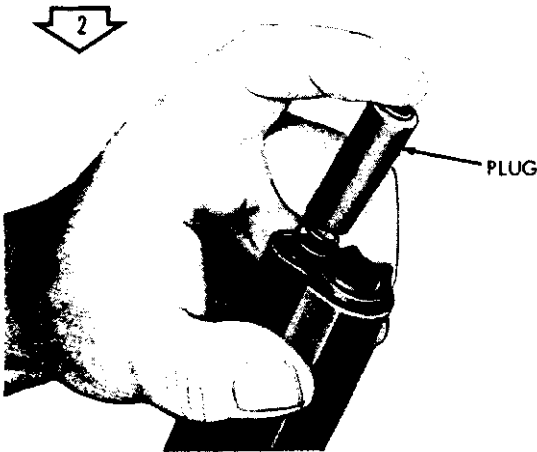

REMOVE/INSTALL RECOIL SPRING PLUG AND SPRING.

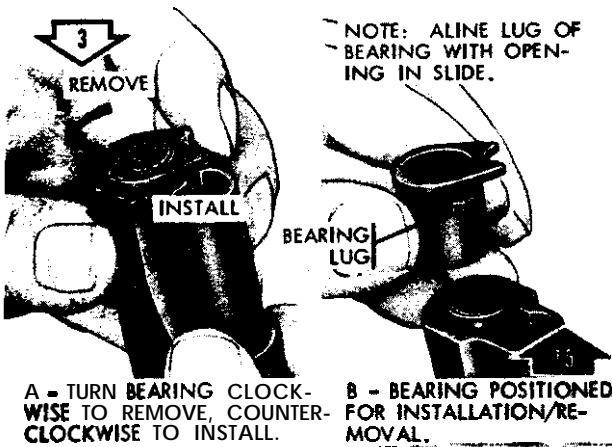

A - TURN BEARING CLOCKWISE TO REMOVE, COUNTERCLOCKWISE TO INSTALL. B - BEARING POSITIONED FOR INSTALLATION/REMOVAL.

REMOVE/INSTALL BARREL BEARING.



COCK HAMMER FOR REMOVING/INSTALLING SLIDE GROUP.

ORD F6611

Figure 18. Disassembly/assembly of barrel and slide group (1 of 4).

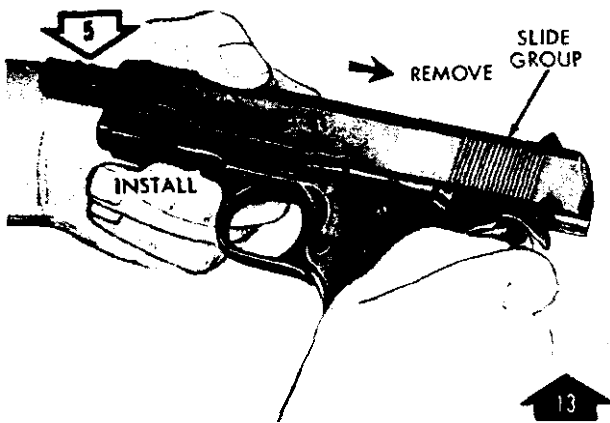

POSITION SLIDE GROUP.

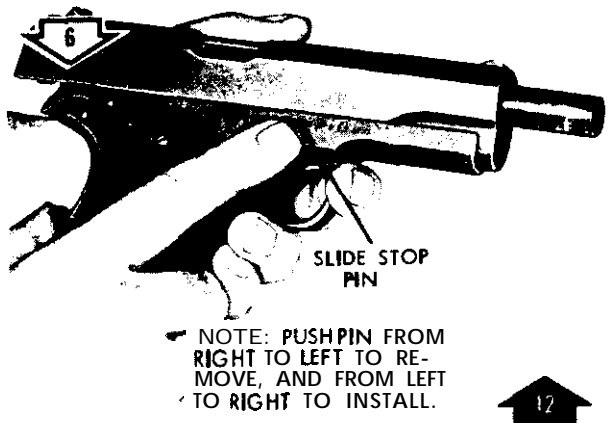

UNSEAT/SEAT PIN PORTION OF SLIDE STOP.

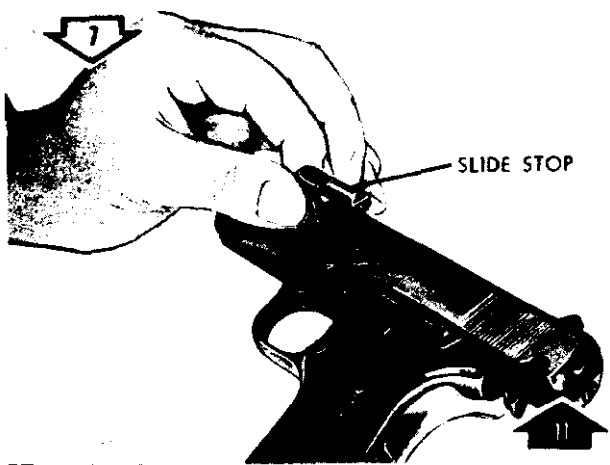

REMOVE/INSTALL SLIDE STOP.

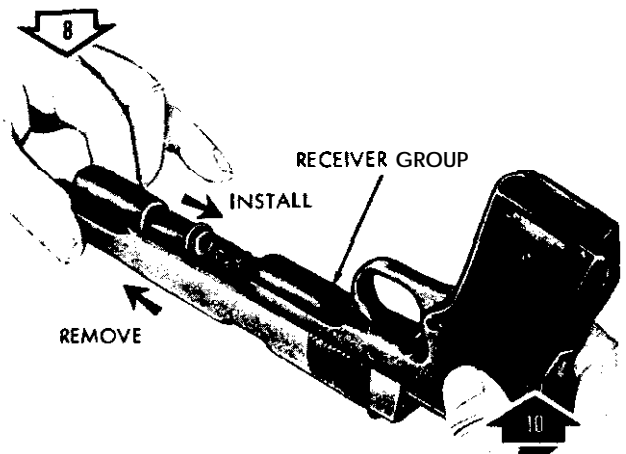

REMOVE/INSTALL SLIDE GROUP FROM RECEIVER GROUP.

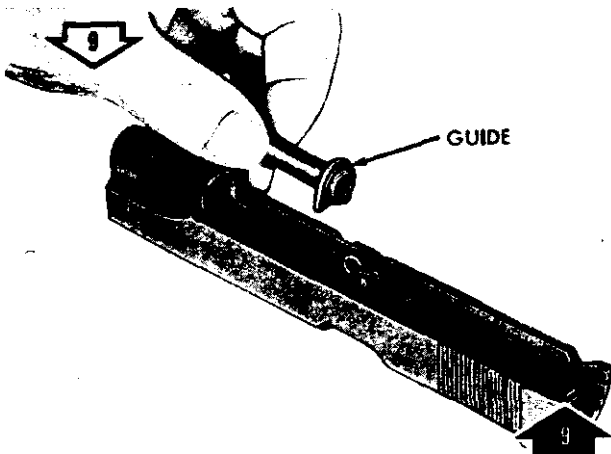

REMOVE/INSTALL RECOIL SPRING GUIDE.

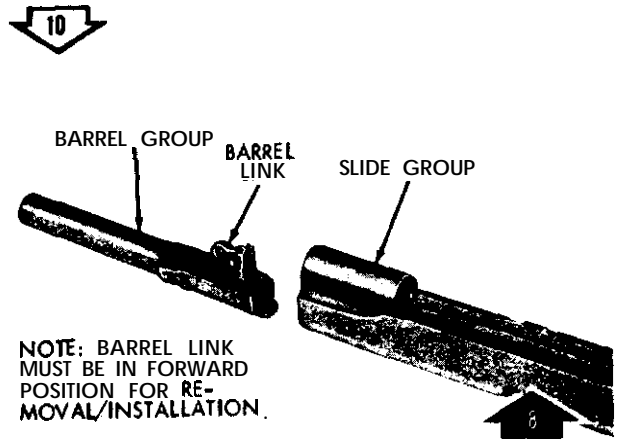

REMOVE/INSTALL BARREL GROUP.

ORD F6612

Figure 19. Disassembly/assembly of barrel and slide group (2 of 4).

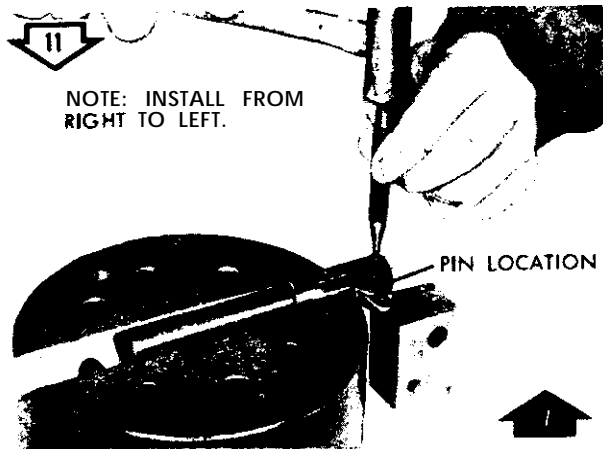

NOTE: INSTALL FROM RIGHT TO LEFT.

PIN LOCATION

REMOVE/INSTALL BARREL LINK PIN.

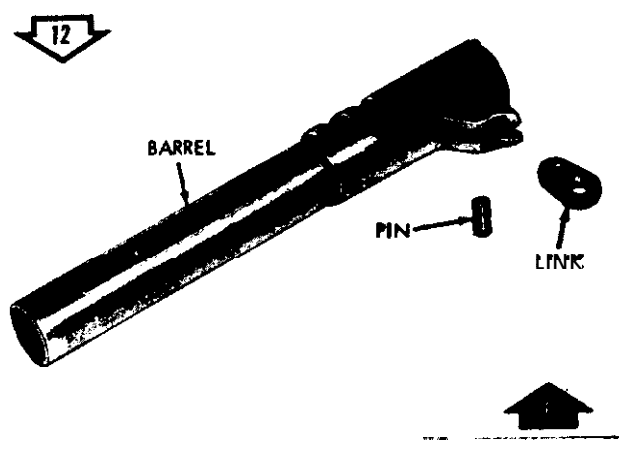

BARREL

PIN

LINK

REMOVE/INSTALL BARREL LINK.

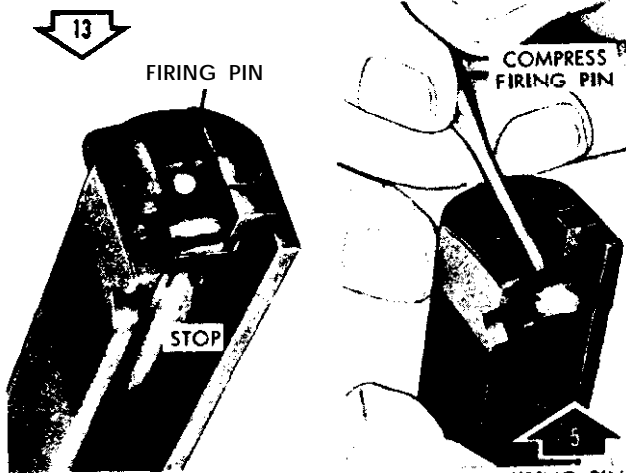

FIRING PIN

COMPRESS FIRING PIN

STOP

A - FIRING PIN AND STOP. B - COMPRESS FIRING PIN TO REMOVE/INSTALL STOP.

REMOVE/INSTALL FIRING PIN STOP.

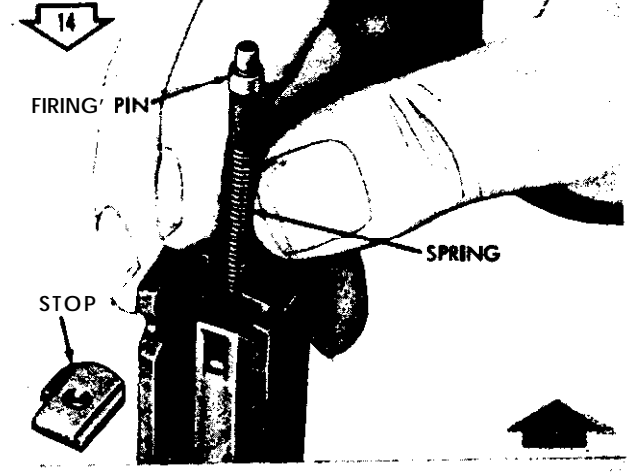

FIRING PIN

SPRING

STOP

REMOVE/INSTALL FIRING PIN AND FIRING SPRING.

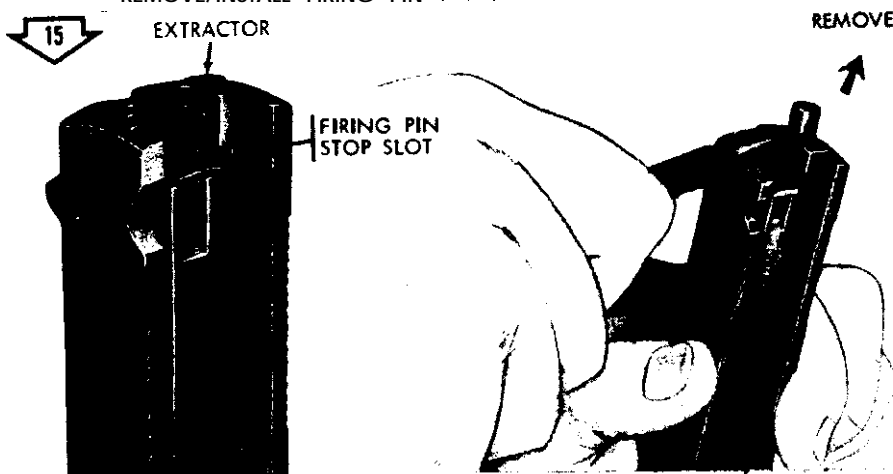

EXTRACTOR

FIRING PIN STOP SLOT

A - CORRECT LOCATION OF EXTRACTOR AT FIRING PIN STOP SLOT.

B - UNSEAT/SEAT EXTRACTOR.

REMOVE/INSTALL CARTRIDGE EXTRACTOR.

REMOVE

NOTE: ALINE SLOT OF EXTRACTOR WITH FIRING/PIN STOP SLOT.

SLOT

EXTRACTOR
FIRING PIN STOP SLOT

SLIDE

C - EXTRACTOR POSITIONED.

ORD F6613

Figure 20. Disassembly/assembly of barrel and slide group (3 of 4).

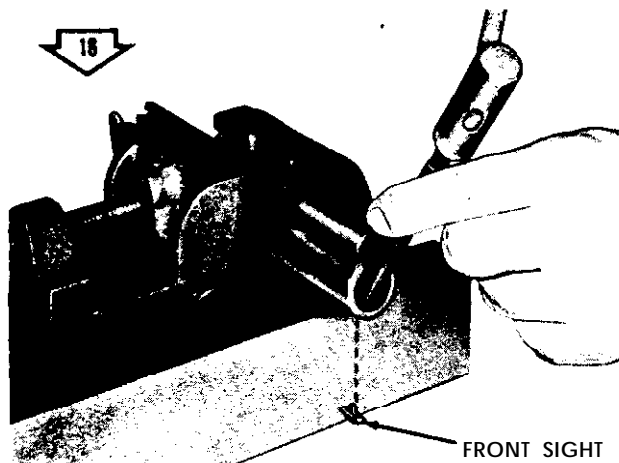

• REMOVE FRONT SIGHT.

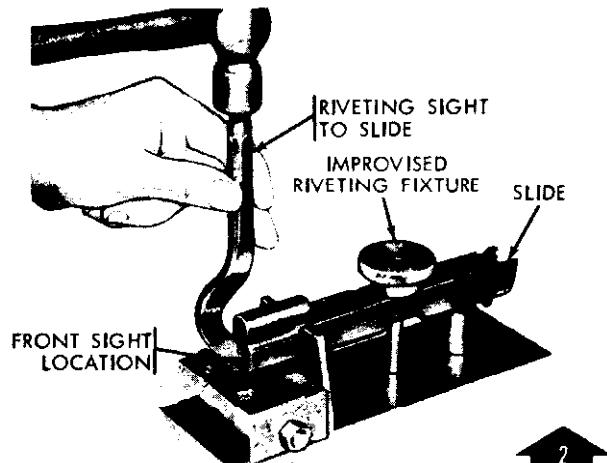

INSTALL FRONT SIGHT.

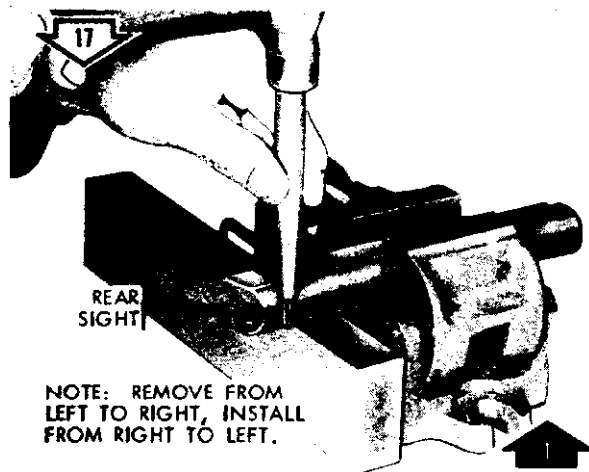

REMOVE/INSTALL REAR SIGHT.

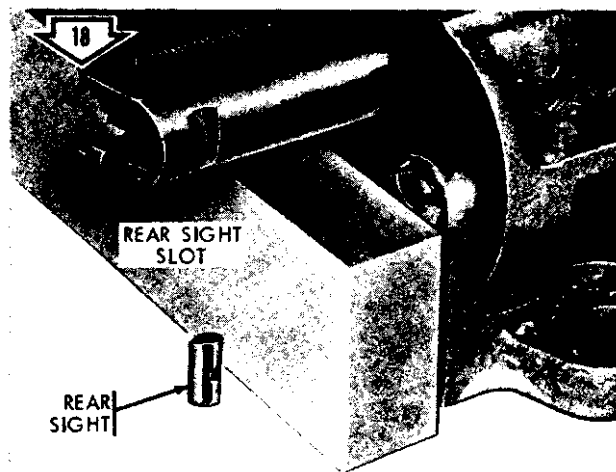

REAR SIGHT REMOVED.

ORD F6614

Figure 21. Disassembly/assembly of barrel and slide group (4 of 4).

surface of the barrel are cause for **rejection**. However, faint rings or shadowy depressions do not indicate an unserviceable barrel and should not be cause for rejection.

g. Inspect the barrel bearing for burs and excessive wear.

h. Inspect slide for breaks or cracks, especially around the ejector port. Inspect the interior grooves and ejector port of slide for excessive wear and burs. Check for loose front or rear sights.

i. Inspect the firing pin for wear or shortness. The pin, as manufactured, has an overall length of 2.290 to 2.296 inches.

j. Inspect the recoil and firing pin springs for weakness or breakage. The free length of recoil spring should be approximately 6-1/2 inches.

k. Examine the extractor for wear, weakness, broken lip or deformation.

l. Inspect the recoil spring plug, recoil spring guide, firing pin stop, barrel link and pin for burs and distortions.

32. Repair

a. Remove burs on exterior and interior rim of barrel and barrel chamber by using a fine stone.

b. Replace barrel if cracked, bulged or

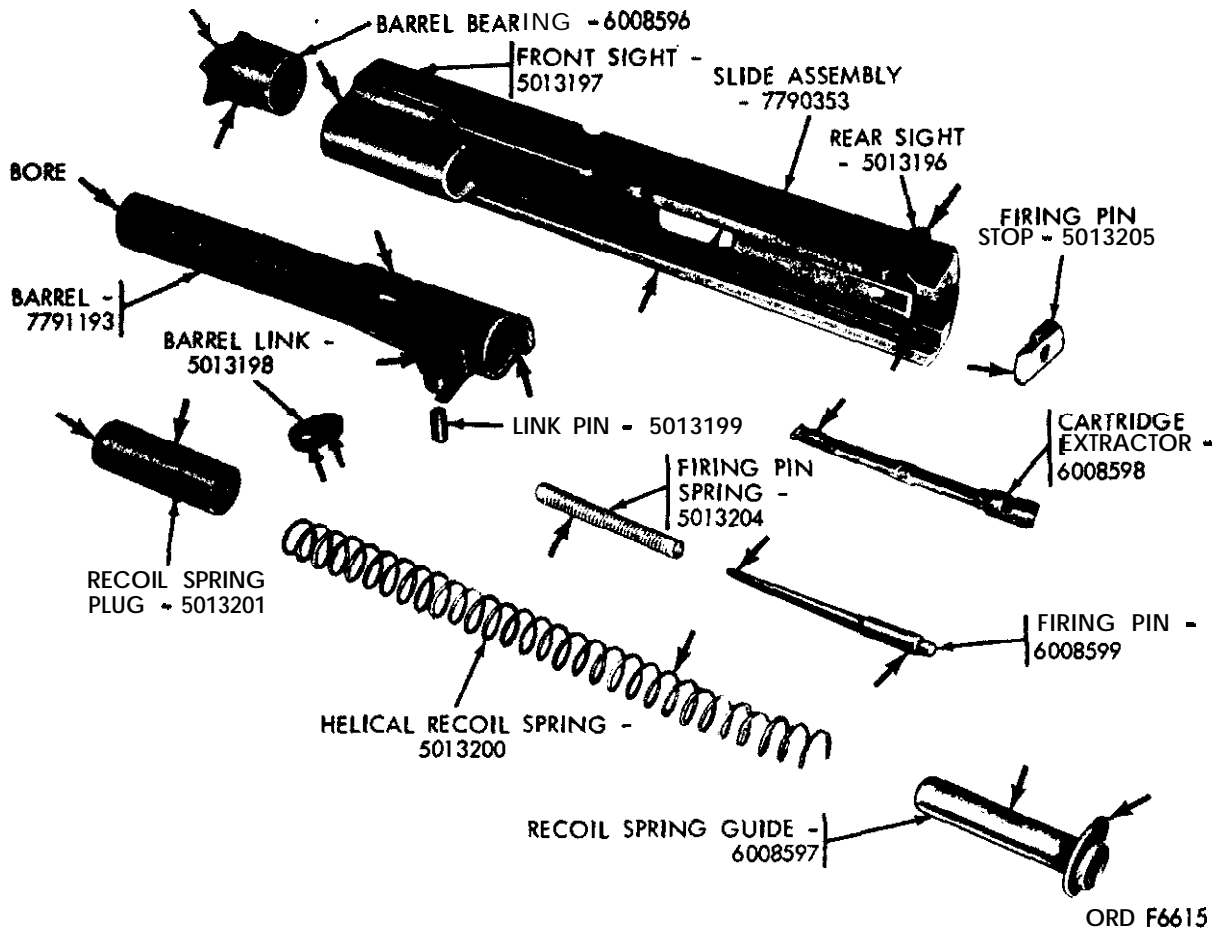
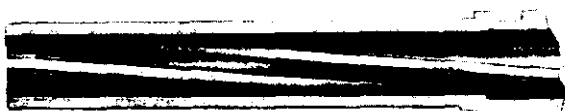

Figure 22. Barrel and slide group - inspection points.



ORD F6619

Figure 23. Interior of barrel showing slight pitting and sharp lands - cutaway view.



ORD F6620

Figure 24. Interior of barrel showing pitting and dull lands - cutaway view.



ORD F6621

Figure 25. Interior of barrel showing pitting, worn lands and burs - cutaway view.

pits are larger than the width of a land or groove or more than three-eighths **inch** in length. **Also**, replace barrel if link lugs are damaged or broken.

c. Replace barrel bearing if worn. Remove burs using a fine stone.

d. Replace barrel link and/or pm if worn, deformed or damaged.

e. Replace worn, damaged or short firing pin.

f. Replace **cracked** or weak recoil and/or firing pm spring.

g. Replace extractor if worn or lip is broken.

h. Remove burs from recoil springplug and guide. Replace, if worn or damaged.

i. Replace front or rear sights **if** damaged to such an extent that the contour of either sight would be insufficient for **ac-**curate sighting of weapon.

j. If front sight is loose; **restake, using riveting fixture.**

k. If rear sight is loose, remove sight, peen top portion of dovetail slot and **replace rear sight, using brass drift (fig. 21).**

33. Assembly

Refer to figures 18 thru 21 for **assembly of barrel and slide group.**

Note. When assembling **firing pin and recoil springs**, small loop of springs will be to the rear.

Section III. RECEIVER GROUP

34. Disassembly

Refer to figures 26 thru 32 for **disassembly of receiver group.**

35. Cleaning

Refer to paragraph 19 for **cleaning of receiver group.**

36. Inspection

a. Inspect the trigger for **burs and wear (fig. 33).** Inspect the half-cock position notch and full-cock notch of hammer for cracks, chips or wear. Make certain the hammer strut is not bent or cracked.

b. Inspect the sear for worn or chipped tips or worn lugs.

c. Inspect the sear spring for broken leaves, cracks and tension.

d. Inspect disconnecter for burs and wear.

e. Inspect the grip safety for **burs**, wear and cracks on the tip **which** engages the trigger.

f. Inspect the **pin** portion and lug of safety for wear or damage.

g. Inspect the helical compression housing spring (fig. 34) for cracks and tension.

h. Inspect mainspring cap pin, detent plunger, and straight-headed pin for burs, wear or damage.

i. Inspect for bent or worn mainspring housing pin and spring pin.

j. Inspect slide stop, slide stop plunger and safety plunger for **burs**, wear or damage.

k. Inspect magazine catch and magazine catch lock for burs and wear. **Check magazine catch spring** for tension and damage.

l. Inspect helical compression spring (housing) for burs on mating surfaces and

lanyard loop for being bent, worn or damaged.

m. Inspect grips for cracks and worn checkering.

n. Inspect the receiver housing (fig. 35) for wear or burs in the slide mating grooves. Inspect the receiver for deformation. Check to see that the plunger tube, ejector, ejector pin, and grip **screw bushings** are not burred or worn. Check the mainspring housing mating grooves in the receiver for **burs**. Check slide stop notch for oversize or wear.

37. Repair

a. Remove burs from slide mating surfaces of receiver housing and mainspring housing mating surfaces, using a fine stone.

b. Replace slide stop plunger and safety plunger, and ejector if worn or damaged. Replace plunger tube using staking plunger tube **tool**. Replace all bushings that have been removed from receiver housing, using staking bushing tool.

c. Remove burs from trigger, replace if worn or damaged.

d. Replace hammer if cracked, chipped or worn.

e. Replace hammer strut if bent, cracked, worn or damaged.

f. Replace sear if lugs are worn and tips are worn or chipped.

g. Replace sear spring if leaves are broken or cracked, or tension is weak.

h. Remove burs from disconnecter, replace if worn or damaged.

i. Remove burs from grip safety, replace if cracked or worn on tip.

j. Replace safety if worn or damaged.

k. Replace the helical compression

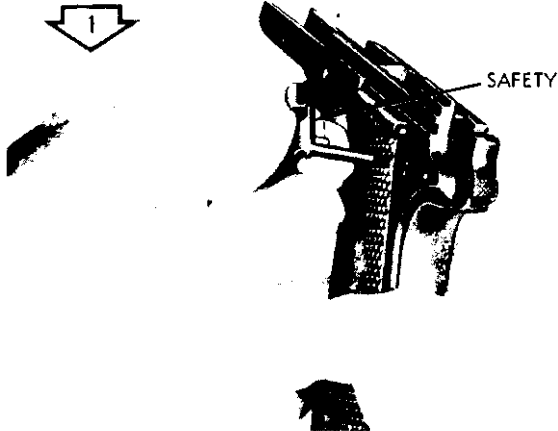

REMOVE SAFETY.

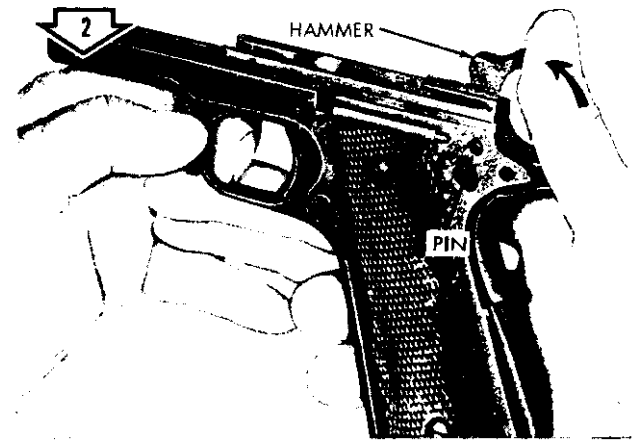

RELEASE HAMMER PRIOR TO REMOVING HAMMER PIN.

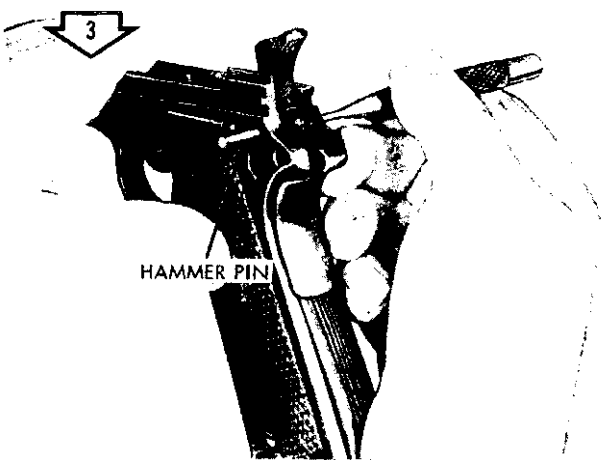

REMOVE HAMMER PIN.

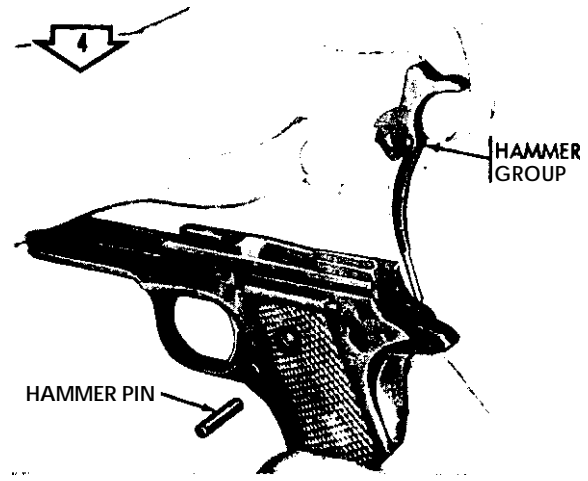

REMOVE HAMMER GROUP

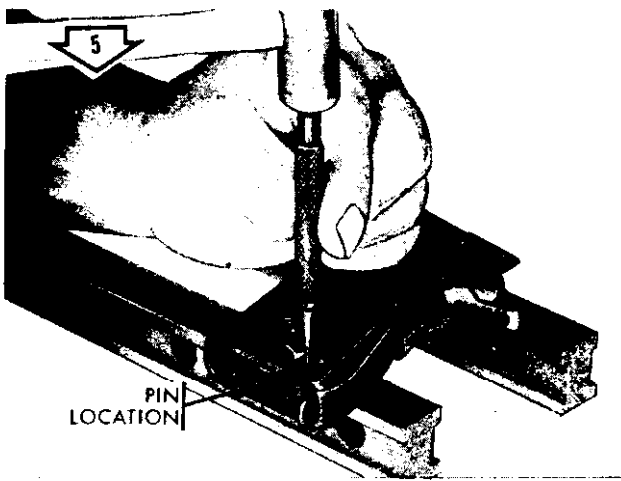

REMOVE MAINSPRING HOUSING PIN.

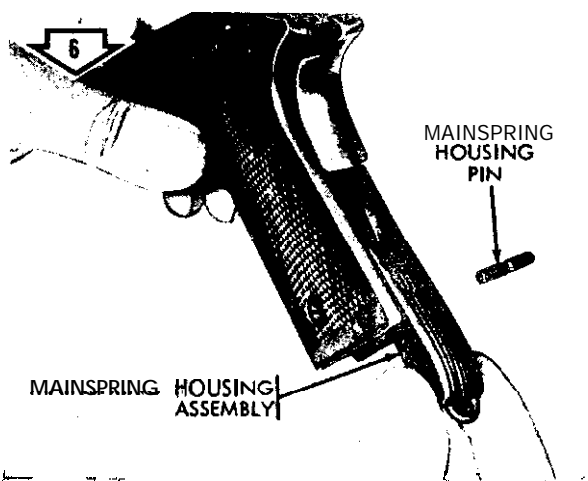

REMOVE MAINSPRING HOUSING ASSEMBLY.

ORD F6622

Figure 26. Disassembly/assembly of receiver group (1 of 7).

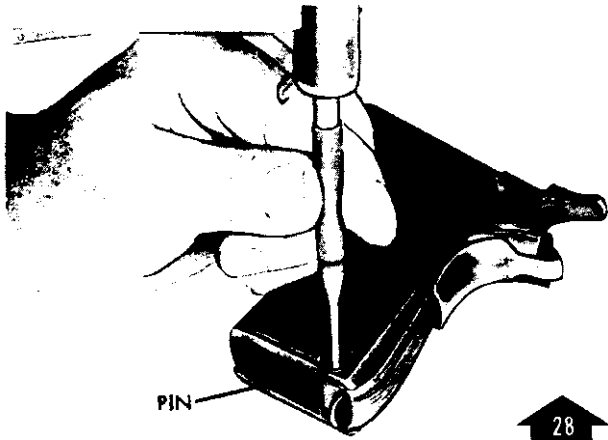

INSTALL MAINSPRING HOUSING PIN.

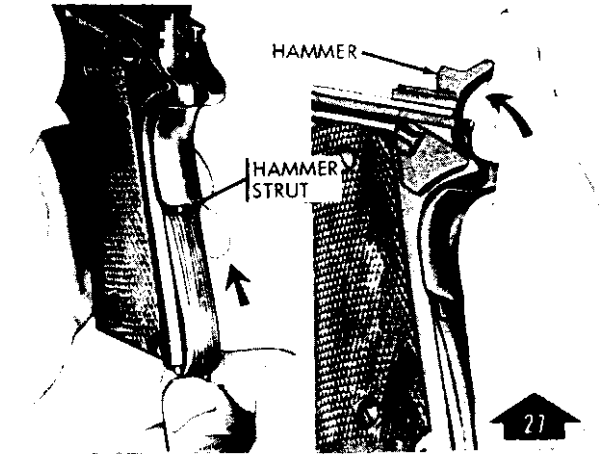

RELEASE HAMMER AND POSITION HAMMER STRUT INTO MAINSPRING HOUSING ASSEMBLY.

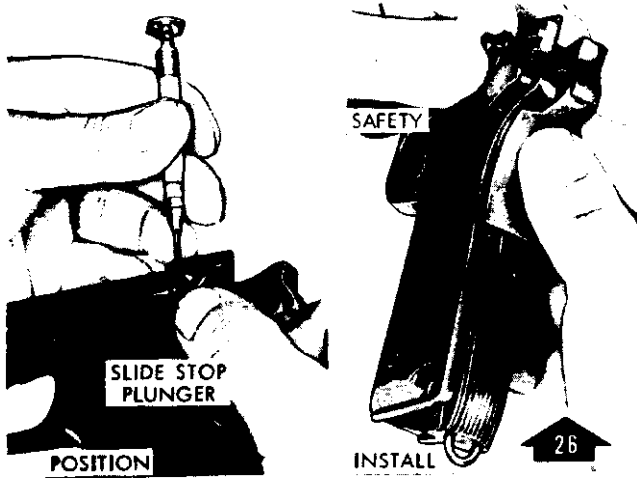

INSTALL AND POSITION SAFETY.

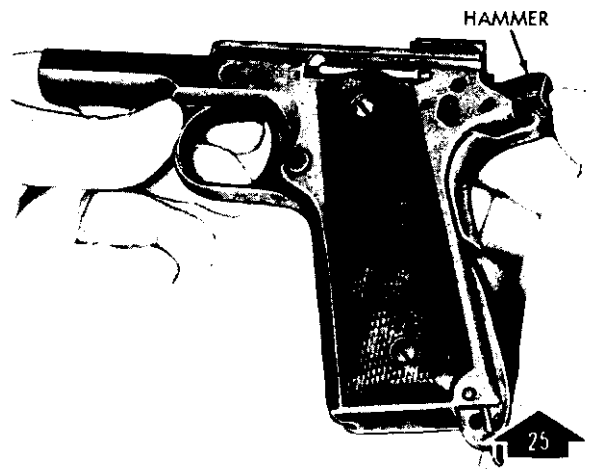

COCK HAMMER PRIOR TO INSTALLING SAFETY.

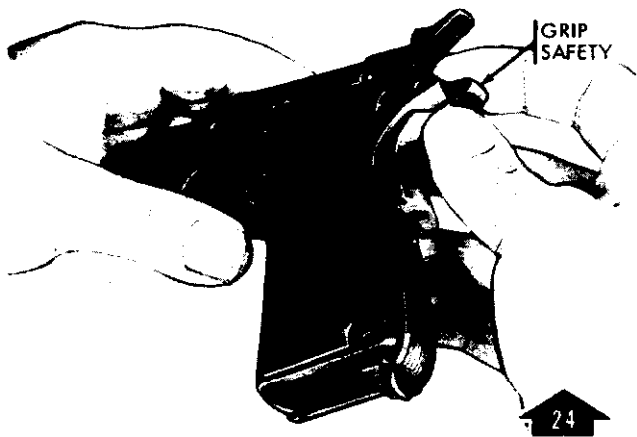

DROP HAMMER STRUT AND INSTALL GRIP SAFETY.

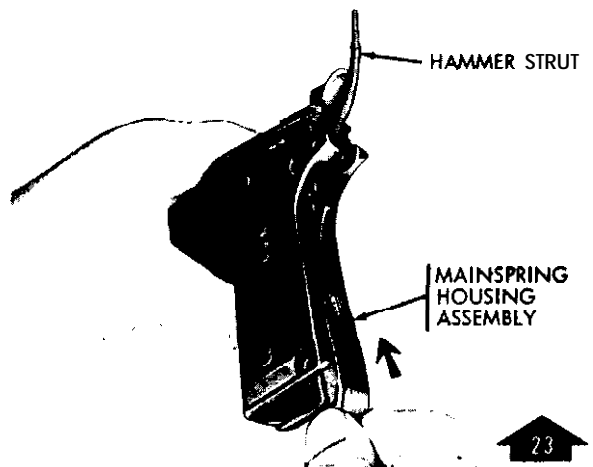

PARTIALLY INSTALL MAINSPRING HOUSING ASSEMBLY TO HOLD SEAR SPRING IN POSITION.

ORD F6623

Figure 27. Disassembly/assembly of receiver group (2 of 7).

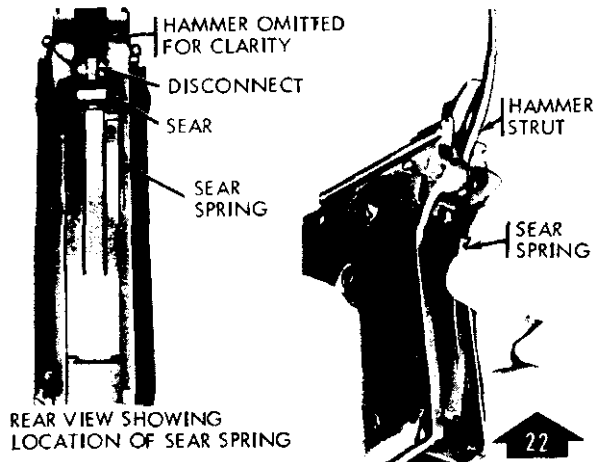

REAR VIEW SHOWING LOCATION OF SEAR SPRING

RAISE HAMMER STRUT AND INSTALL SEAR SPRING.

NOTE: WHEN INSTALLING HEAD OF PIN SHOULD BE ON LEFT SIDE.

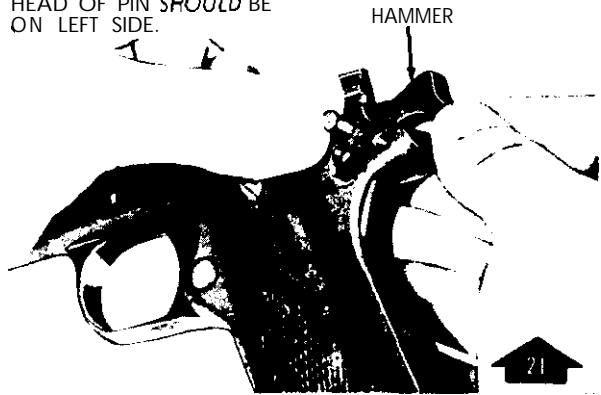

INSTALL HAMMER AND HAMMER PIN.

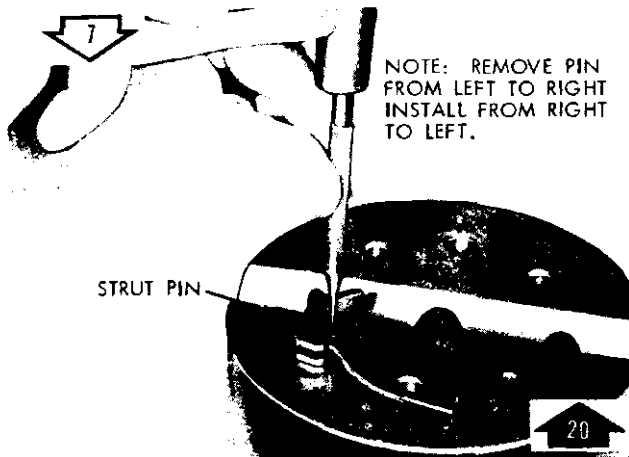

NOTE: REMOVE PIN FROM LEFT TO RIGHT
INSTALL FROM RIGHT TO LEFT.

REMOVE/INSTALL HAMMER STRUT PIN.

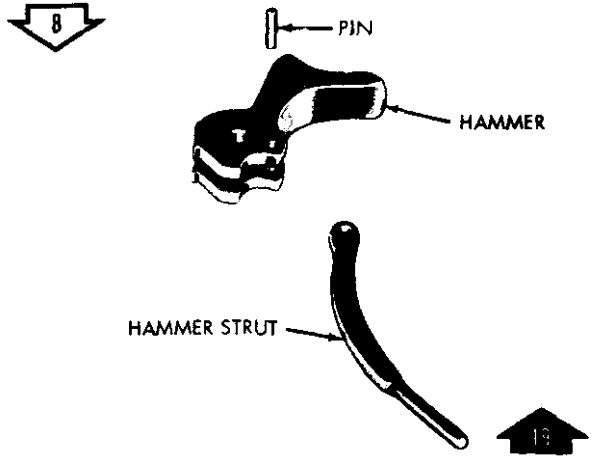

SEPARATE/CONNECT HAMMER STRUT AND HAMMER.

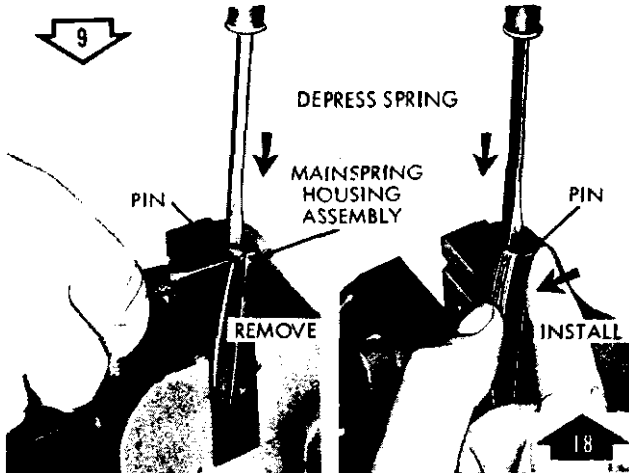

REMOVE/INSTALL STRAIGHT HEADED PIN.

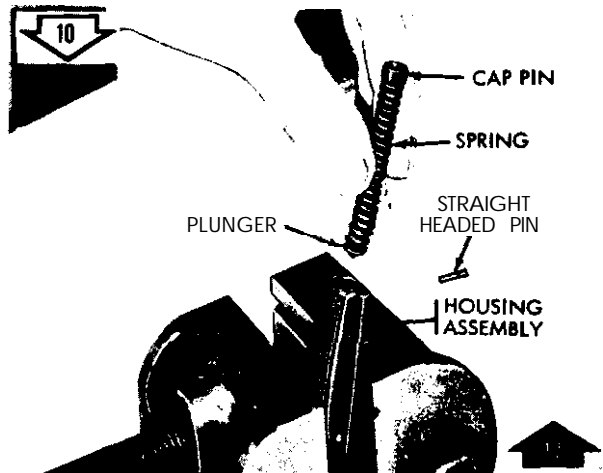

REMOVE/INSTALL MAINSPRING, CAP PIN, HELICAL COMPRESSION SPRING AND DETENT PLUNGER.

ORD F6624

Figure 28. Disassembly/assembly of receiver group (3 of 7).

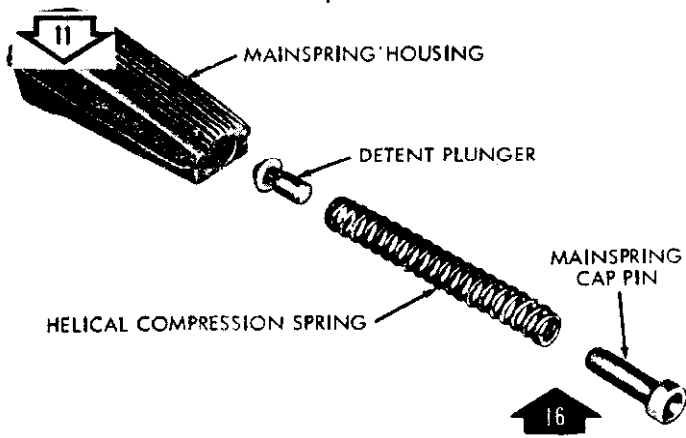

11 SEPARATE/CONNECT DETENT PLUNGER, HELICAL COMPRESSION SPRING AND MAINSRING CAP PIN.

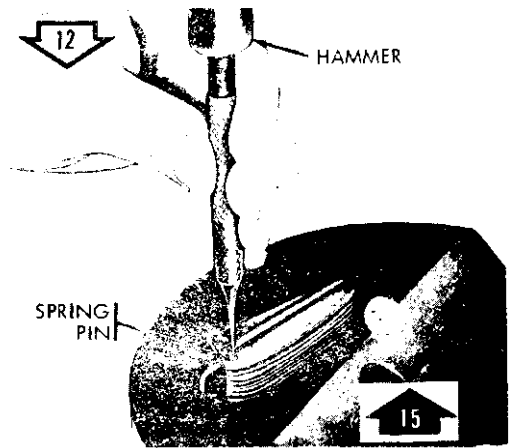

12 REMOVE/INSTALL LANYARD LOOP SPRING PIN.

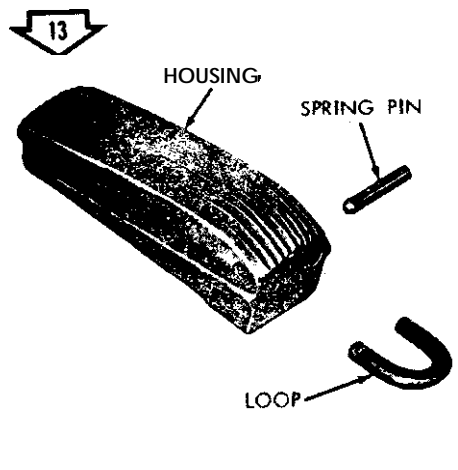

13 SEPARATE/CONNECT LANYARD LOOP.

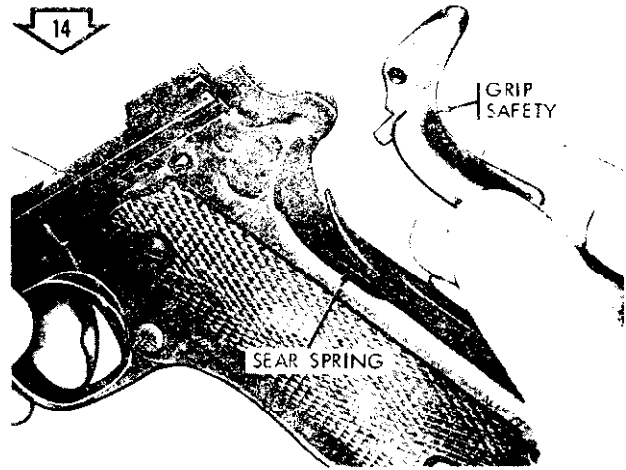

14 REMOVE GRIP SAFETY.

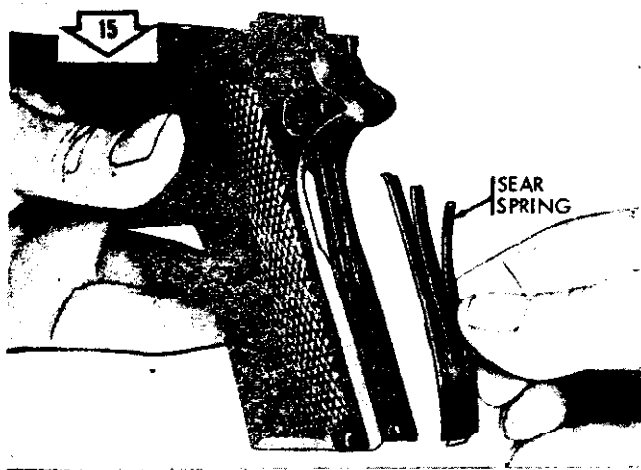

15 REMOVE SEAR SPRING.

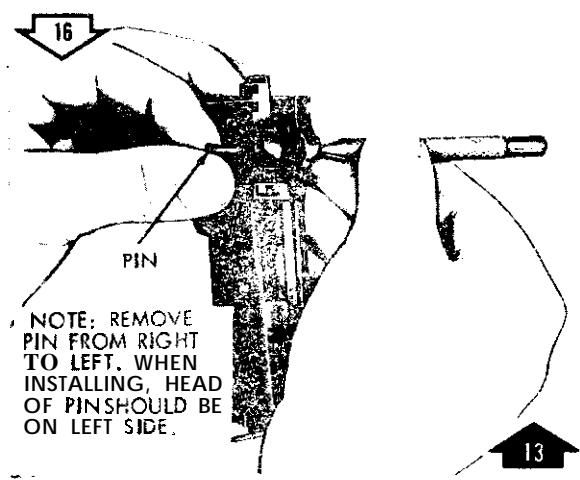

16 REMOVE/INSTALL SEAR PIN.

NOTE: REMOVE PIN FROM RIGHT TO LEFT. WHEN INSTALLING, HEAD OF PIN SHOULD BE ON LEFT SIDE.

ORD F6625

Figure 29. Disassembly/assembly of receiver group (1/2 of 1).

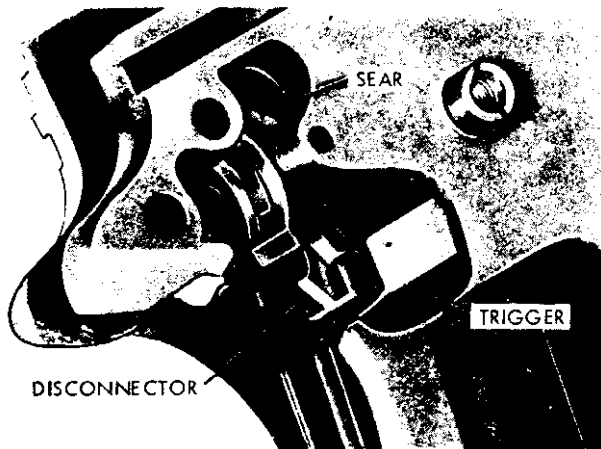

CUTAWAY VIEW SHOWING LOCATION OF SEAR AND DISCONNECTOR.

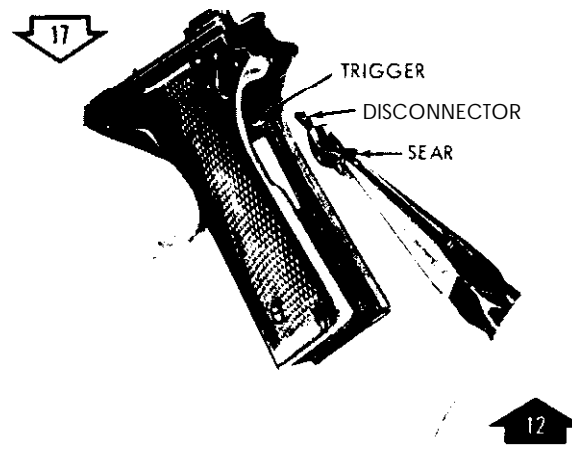

REMOVE/INSTALL SEAR AND DISCONNECTOR

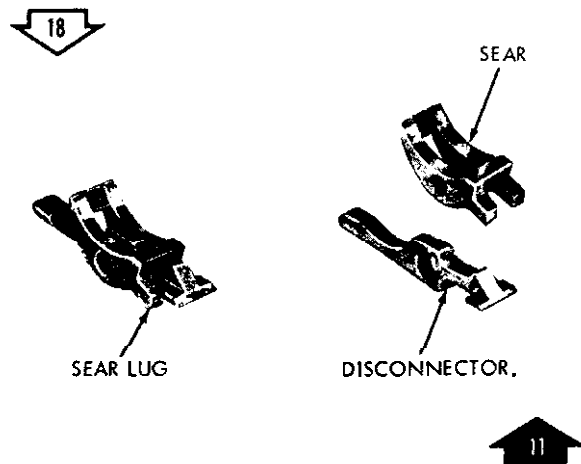

SEPARATE/CONNECT SEAR AND DISCONNECTOR.

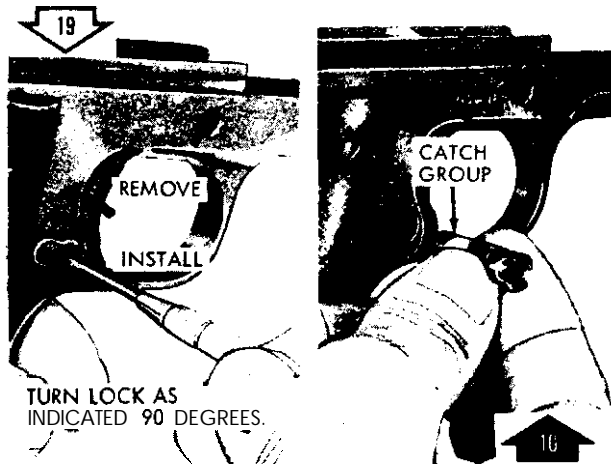

UNLOCK/LOCK CATCH GROUP
REMOVE/INSTALL MAGAZINE CATCH GROUP.

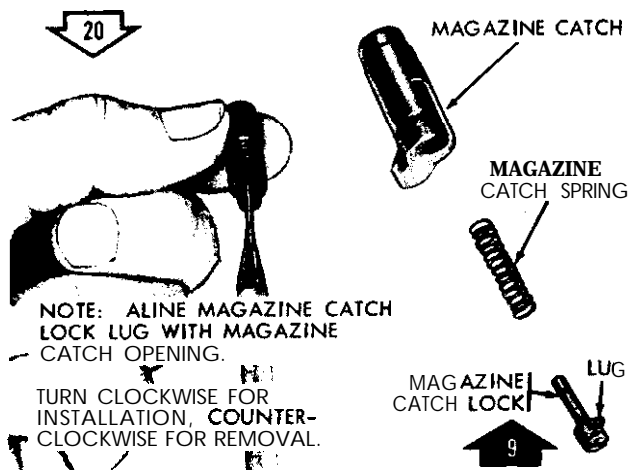

NOTE: ALINE MAGAZINE CATCH LOCK LUG WITH MAGAZINE CATCH OPENING.

TURN CLOCKWISE FOR INSTALLATION, COUNTER-CLOCKWISE FOR REMOVAL.

SEPARATE/CONNECT MAGAZINE CATCH LOCK AND MAGAZINE CATCH SPRING.

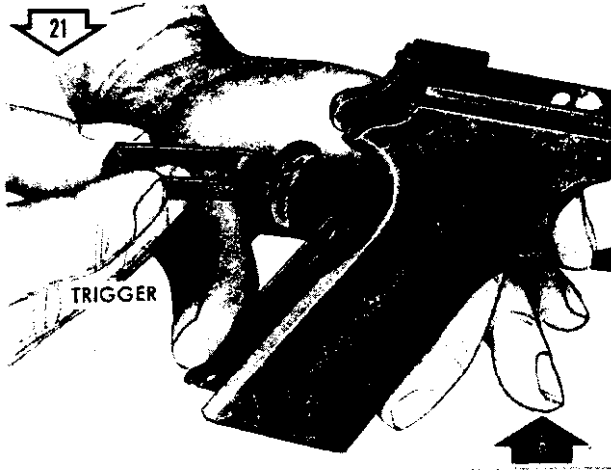

REMOVE/INSTALL TRIGGER.

ORD F6626

Figure 30. Disassembly/assembly of receiver group (5 of 7)

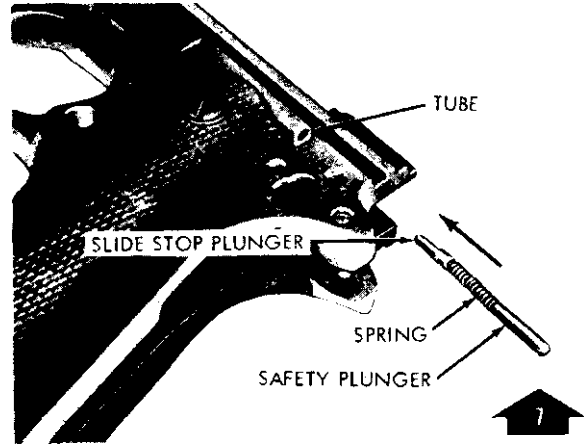
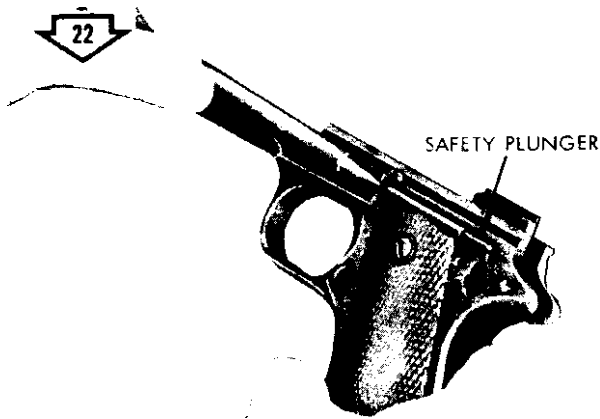

REMOVE/INSTALL SLIDE STOP PLUNGER, HELICAL COMPRESSION SPRING AND SAFETY PLUNGER

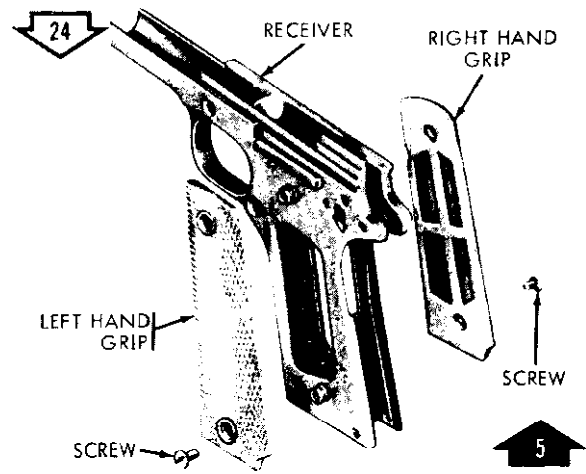
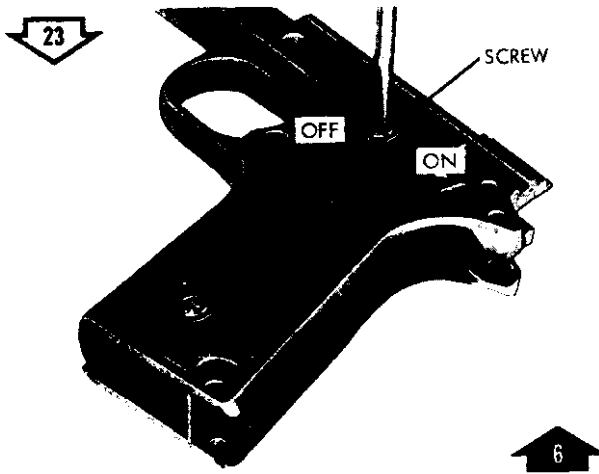

REMOVE/INSTALL GRIP SCREWS.

REMOVE/INSTALL PLASTIC GRIPS.

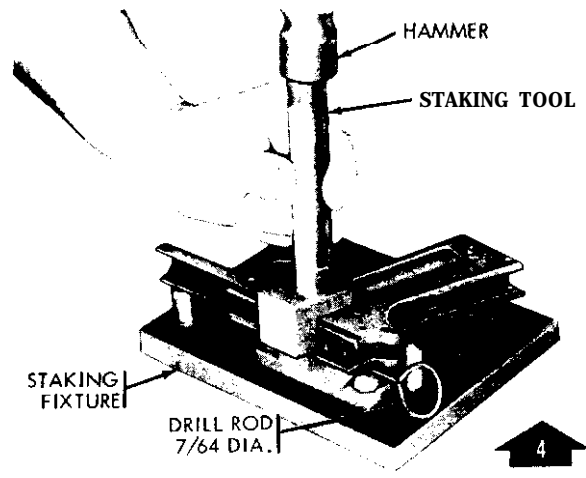
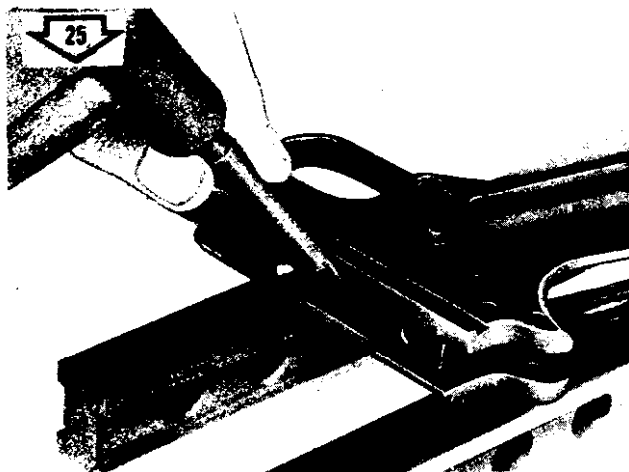

UNSEATING PLUNGER TUBE

INSTALL/STAKE PLUNGER TUBE ON RECEIVER.

ORD F6627

Figure 3.. Disassembly/assembly of receiver group (6 of 7).

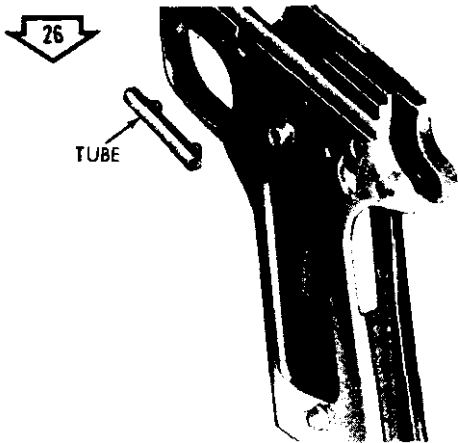

REMOVE PLUNGER TUBE

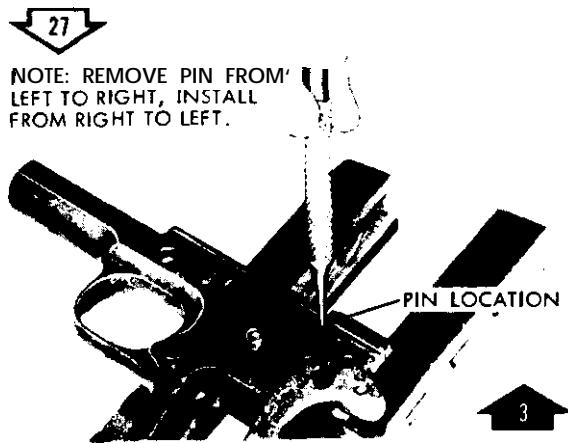

NOTE: REMOVE PIN FROM LEFT TO RIGHT, INSTALL FROM RIGHT TO LEFT.

REMOVE/INSTALL EJECTOR PIN.

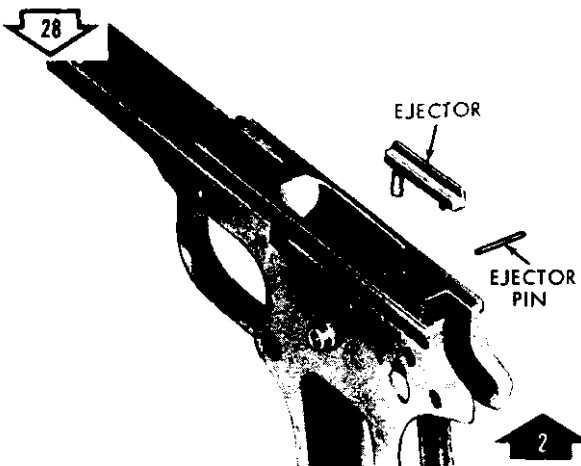

REMOVE/INSTALL CARTRIDGE EJECTOR.

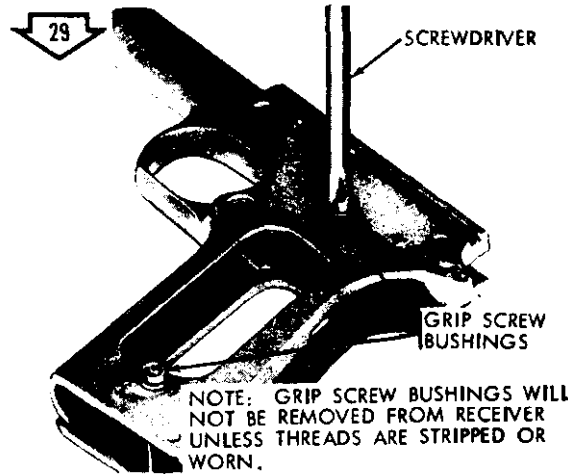

REMOVE GRIP SCREW BUSHINGS.

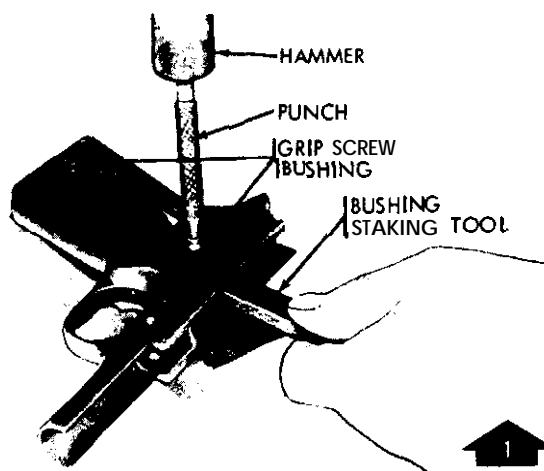

INSTALL AND STAKE GRIP SCREW BUSHINGS

ORD F6628

Figure 32. Disassembly/assembly of receiver group (7 of 7).

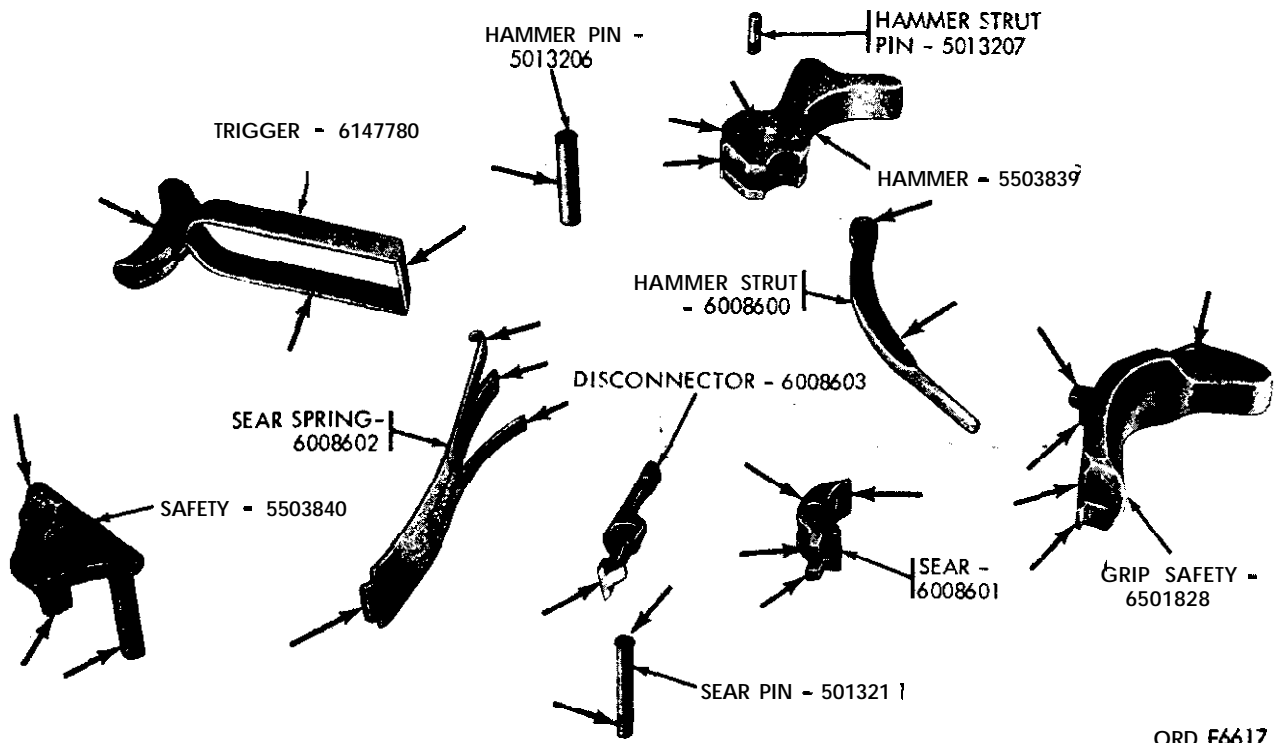

ORD F6617

Figure 33. Receiver group - inspection points (1 of 3).

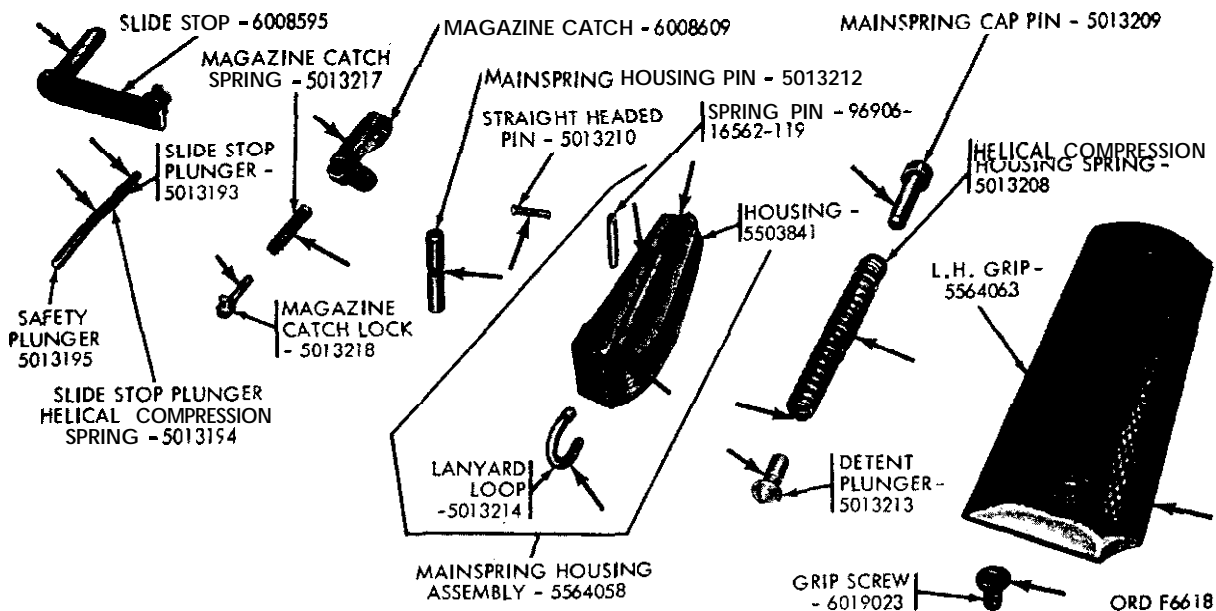

ORD F6618

Figure 34. Receiver group - inspection points (2 of 3).

spring (housing). if damaged or tension is weak.

1. Remove hurs from mainspring cap pin, detent plunger, and straight headed

pin. Replace, if worn or damaged.

m. Replace mainspring housing pin and spring pin if bent or worn.

n. Remove burs from slide stop, slide

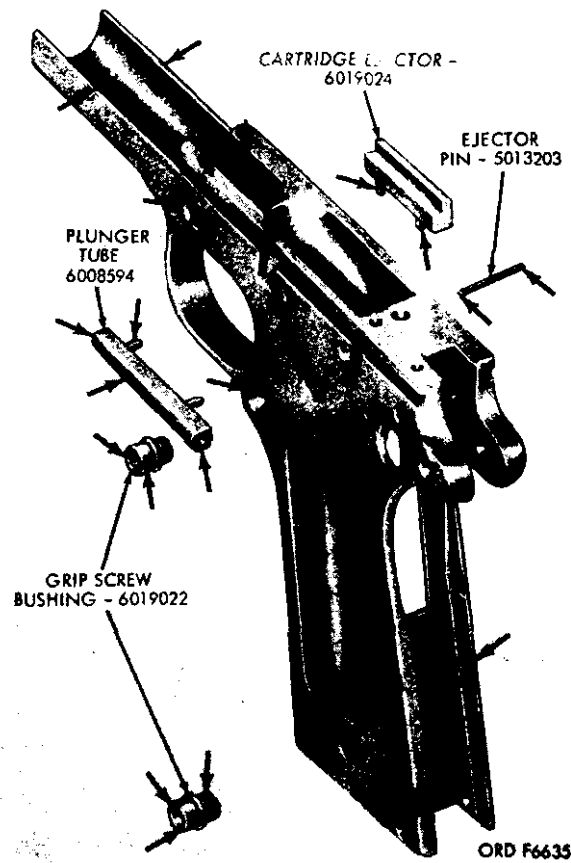

Figure 35. Receiver group - inspection points (3 of 3).

stop plunger and safety plunger. Replace, if worn or damaged.

o. Remove burs from magazine catch and magazine **catch** lock. Replace **if worn**. Replace magazine catch spring if damaged or **tension is weak**.

p. Remove burs from the mating surfaces and mainspring housing. Replace lanyard loop if bent or damaged.

q. Replace grips if broken or **checking** is worn.

38. Assembly

Refer to figures 26 **thru** 32 for **assembling** of receiver group.

CHAPTER 6

FINAL INSPECTION

39. General

Pistols turned in for repair may be assumed to have defects caused by use or neglect. When they were accepted as new weapons, the parts composing them were dimensionally correct and made of the proper material. The inspection of these weapons after repair will differ from the inspection procedure used in the manufacturing plant in that attention will be directed to wearing surfaces, parts that might crack or break due to high stress or fatigue, and evidences of corrosion. These defects do not evidence themselves by uniform reduction in a given dimension but show up as a chipped edge, a partially worn surface, or an eccentric hole. A gage used in manufacturing is merely a means of comparing an unknown dimension with a known one to judge whether a piece comes within tolerances. After this piece is worn through use, the change in dimension is more easily detected in many cases by comparing with adjacent surfaces; the piece in itself becomes a gage. Visual inspection, therefore, is far more applicable in these cases and gaging is limited to those dimensions that are critical or that may be more advantageously measured than compared. Inspection of non-critical parts (parts that do not ordinarily cause malfunctions) will be limited to appearance and the presence of cracks or flaws. The dimensions and tolerances placed on the parts (and gaging used during manufacturing) were for the sole purpose of insuring interchangeability. Even if the dimensions of such parts are worn considerably below drawing tolerance, functioning and interchangeability will not be adversely affected and the parts are consequently acceptable. The serviceability of the material must also be determined by conducting inspection as described in paragraphs 13 through 16.

40. Specific Inspection Procedures

a. Visual Inspection. Visual and overall appearance of the pistol should be approximately that of a new weapon. All exposed metal surfaces are to have a phosphate-finish. The color will range from black to medium light gray. Bright surfaces are objectionable from standpoint of visibility when they are capable of reflecting light. All outside surfaces will be free of burs or deep scratches. Barrels must be straight, clean and free of rust and powder fouling and free from bulges and rings. Pistols must be complete. All applicable modifications must be applied. The serial number must be legible and all parts must be free of rust. Visually inspect the following:

- (1) Check front and rear sights, make certain they are tight and properly aligned.
- (2) Check for split or damaged plastic grips and loose grip screws.

b. Functional Inspection.

- (1) Check functioning of safety. Refer to paragraph 15c(1).
 - (2) Check functioning of grip safety. Refer to paragraph 15c(2).
 - (3) Check functioning of hammer or sear. Refer to paragraph 15c(3).
 - (4) Check functioning of disconnecter. Refer to paragraph 15c(4).
 - (5) Upon completion of inspection, pistols will be properly cleaned and lubricated (paragraphs 19 and 23).
- o. Trigger Pull Test.** Check the trigger pull using trigger pull measuring fixture (figs. 5 and 36) and in accordance with instructions indicated in (1) and (2) below:
- (1) With the safety unlocked, rest the weight on the floor and hook the notched portion of the rod over the center portion of the trigger.

Note. Make certain the rod does not contact or rub any portion of the pistol and that

rod and barrel are parallel. Empty magazine must be installed when checking trigger pull.

- (2) Depress grip safety and carefully raise the weight from the floor. When using the 5 pound weight (minimum), the trigger should not release the hammer. When using the 6.5 pound weight (maximum), the trigger should release the hammer.

Caution: A slow or steady lift must be utilized to assure a true and accurate check.

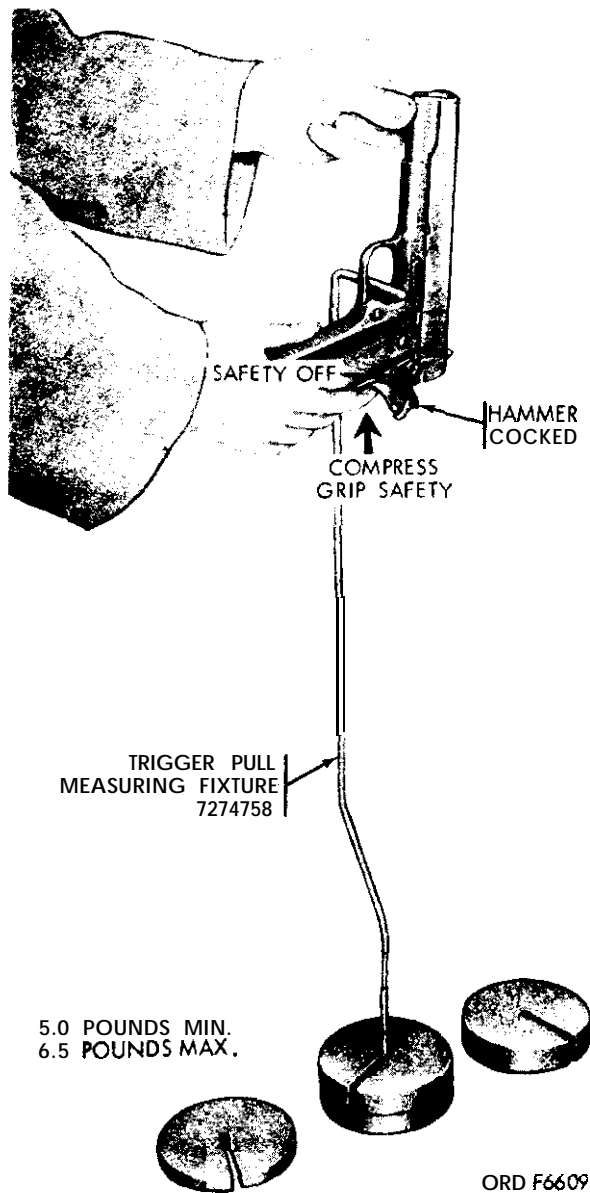

Figure 36. Checking trigger pull.

d. Correcting Trigger Pull.

- (1) **Trigger pull too light.** This is evidence of a worn cocking notch on the hammer, worn or damaged sear or a weak helical compression housing spring. Examine the components for wear or damage. If trigger pull cannot be corrected by **stoning**, replace with new components as required.
- (2) **Trigger pull excessive.** This is evidence of burs or surface irregularities on the hammer full-cock notch or sear. A helical housing spring that is damaged or too strong and/or interferences or binding between the mating surfaces of the pertinent parts within the receiver group are other probable causes. If the trigger pull cannot be corrected by stoning, replace with new components as required.
- (3) **Creep in trigger.** Creep is defined as a perceptible movement of the trigger after the slack has been taken up and before the hammer is released. It is caused by rough or uneven mating surfaces of the sear, hammer, and disconnect and also by unserviceable sear and hammer pins. If the creep cannot be corrected by stoning, replace with new components as required.

Caution: While stoning, critical dimensions should not be altered.

e. Hand Function Test.

- (1) Place three dummy cartridges in magazine (fig. 37). Insert magazine in receiver group. Release slide stop. This action would cause barrel and slide group to move forward. At the same time, a dummy cartridge will be stripped from magazine into chamber of the weapon.
- (2) Release safety (fig. 38).
- (3) Squeeze trigger, allowing hammer to fall (fig. 39). Continue test until third cartridge has been ejected from the pistol, simulating dry firing.
- (4) When last cartridge is ejected, slide group should remain locked

in open position by slide stop (fig. 40).
 (5) Pistols that fail to meet the re-

quired functioning test will be corrected by replacement of defective components.

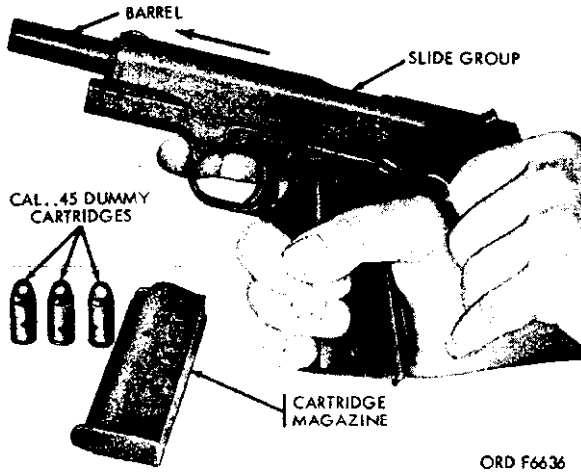

ORD F6636

Figure 37. Position of hands when loading weapon -left front view.

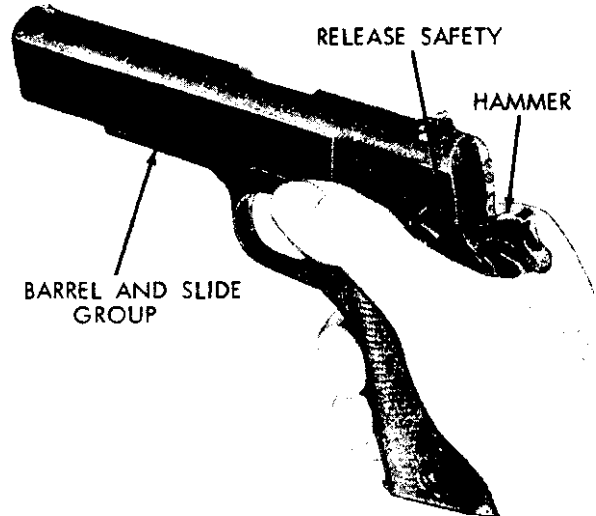

ORD F6644

Figure 38. Hammer cocked -ready to begin function firing.

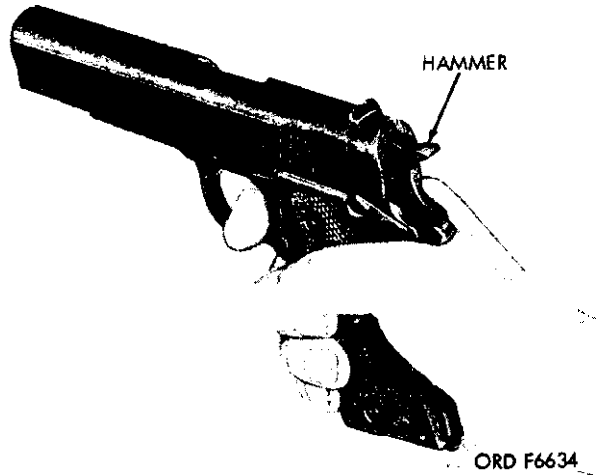

ORD F6634

Figure 39. Weapon in battery position.

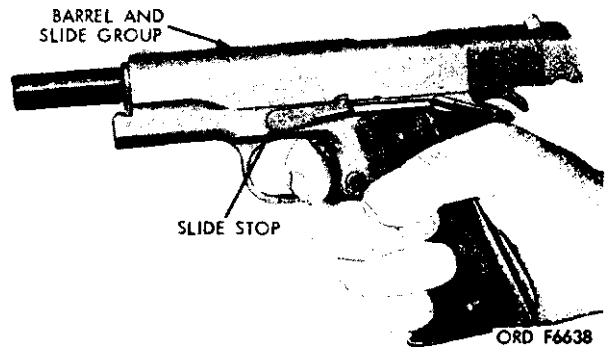

ORD F6638

Figure 40. Slide group locked in open position after last cartridge is fired.

in open position by slide stop (fig. 40).
 (5) Pistols that fail to meet the re-

quired functioning test will be corrected by replacement of defective components.

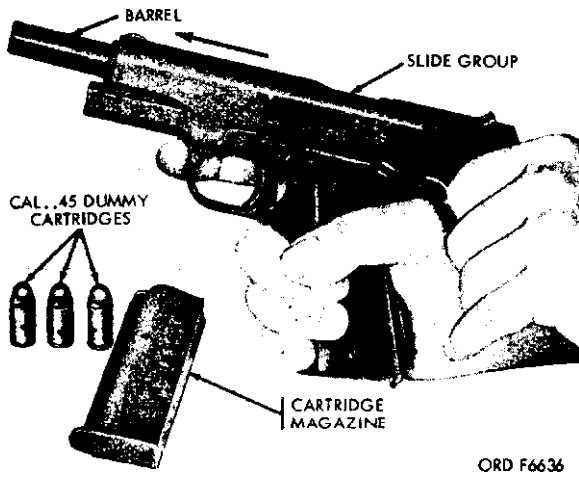

ORD F6636

Figure 37. Position of hands when loading weapon—left front view.

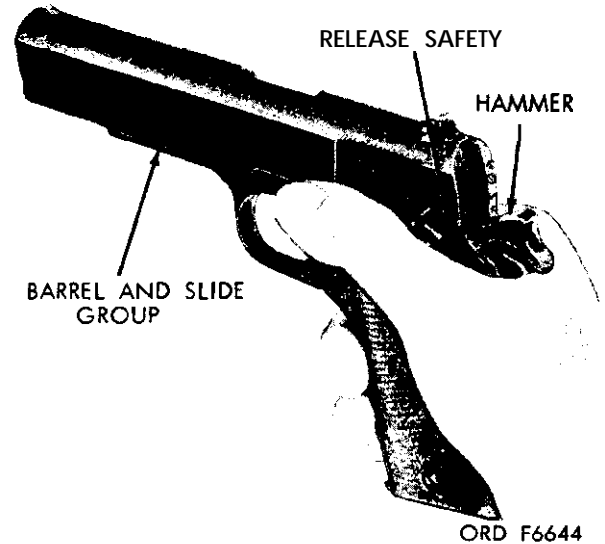

ORD F6644

Figure 38. Hammer cocked—ready to begin function firing.

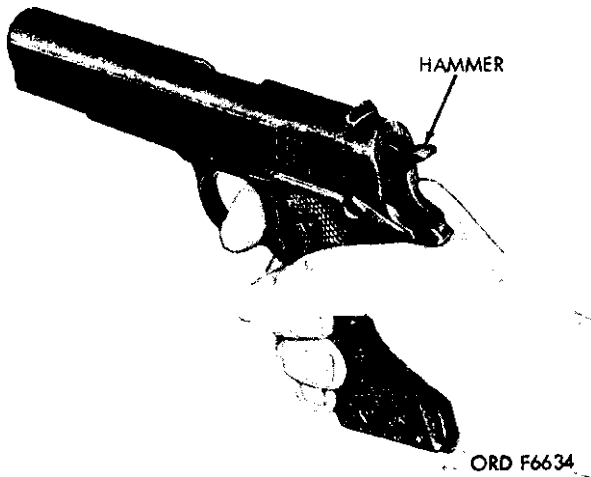

ORD F6634

Figure 39. Weapon in battery position.

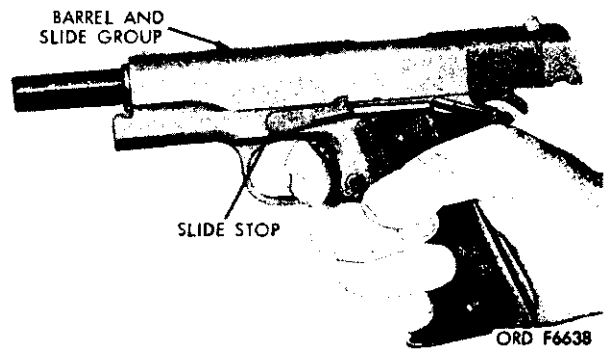

ORD F6638

Figure 40. Slide group locked in open position after last cartridge is fired.

CHAPTER 7

PREPARATION AND SHIPPING INSTRUCTIONS

41. Preparation

a. Cleaning. All metal parts shall be thoroughly cleaned by process C-3 of Specification **MIL-P-116C**. Surfaces of parts subjected to burned powder residues will be cleaned with solvent cleaning compound (PD 126) conforming to Specification **MIL-C-372B**.

b. Drying. All surfaces will be thoroughly dried by wiping with clean cloths or by blowing the surface with a **blast** of clean dry compressed air from a line equipped with filter moisture traps.

c. Preservation. Pistols will be coated with a lubricating oil (PL special) **making** certain all surfaces are covered, including the entire bore of barrel.

d. Packaging. Each pistol will be individually wrapped in a heavy-duty grease-proof paper. All protruding edges will be cushioned, using several thicknesses of grease-proof paper prior to wrapping.

e. Packing. Pack a maximum of **50 pistols** in a suitable wood container box.

Make certain they are adequately blocked to prevent movement during handling and shipping. After closure, apply two flat steel straps around the box.

Note. For further pertinent information and guidance in preservation, packaging and packing of the above named materiel, refer to TM 38-230.

42. Marking Instructions

Standard and precautionary markings will be applied to boxes as prescribed in **TM 9-200**.

43. Shipping Instructions

a. Responsibility. When shipping the pistol the officer-in-charge of preparing the shipment will be responsible for properly processing the materiel for shipment, including the preparation of Army shipping documents.

b. Army Shipping Documents. Prepare all Army shipping documents **in accordance** with **AR 725-50**.

APPENDIX

REFERENCES

1. Publication Indexes

The following indexes will be consulted frequently for the latest changes or revisions of references given in this appendix and for new publications relating to materiel covered in this manual.

Military Publications:

Index of Administrative Publications.	DA Pam 310-1
Index of Army Motion Pictures, Film Strips, Slides, and Phono-Recordings.	DA Pam 108-1
Index of Blank Forms*	DA Pam 310-2
Index of Graphic Training Aids and Devices	DA Pam 310-5
Index of Supply Manuals: Ordnance Corps	DA Pam 310-29
Index of Technical Manuals, Technical Bulletins, Supply Manuals, (types 4, 6, 7, 8 and 9), Supply Bulletins, Lubrication Orders, and Modification Work Orders.	DA Pam 310-4
Index of Doctrinal, Training, and Organizational Publications	DA Pam 310-3

2. Supply Manuals

The following supply manuals of the Department of the Army supply manuals pertain to this materiel:

Operator and Organizational Maintenance Repair Parts and Special Tool Lists for Pistol, Caliber .45, Automatic, M1911A1 with Holster, Hip and Pistol, Caliber .45, Automatic, M1911A1 with Holster, Shoulder.	TM 9-1005-211-12P/2
Direct and General Support Maintenance Repair Parts and Special Tool Lists for Pistol, Caliber .45, Automatic, M1911A1 with Holster, Hip and Pistol, Caliber .45, Automatic, M1911A1 with Holster, Shoulder.	TM 9-1005-211-35P

3. Forms

The following forms pertain to this materiel.

DA Form 2028, Recommended Changes to DA Technical Manual Parts Lists or Supply Manual (cut sheet).
DA Form 2407, Maintenance Request.
DD Form 6, Report of Damaged or Improper Shipment (cut sheet).

4. Other Publications

The following explanatory publications pertain to this materiel.

a. General.

The Army Equipment Record System and Procedures.	TM 38-750
Military Training	FM 21-5
Techniques of Military Instruction	FM 21-6
Military Symbols.. ..	FM 21-30
Military Terms, Abbreviations, and Symbols Authorized Abbreviations and Brevity Codes.	AR 320-50

Dictionary of United States Army Terms AR 320-5

b. Cleaning

Cleaning of Ordnance Materiel TM 9-208-1

Cleaning and Black Finishing of Ferrous Metals TM 9-1861

Cleaning Compound, Solvent (For Bore of
Small Arms and Automatic Aircraft Weapons).
c. Inspection. MIL-C-372B

Command Maintenance Management Inspections AR 750-8

Field Inspection and Serviceability Standards
for Small Arms Materiel. TB ORD 587

d. Issue of Supplies and Equipment.

Requisitioning, Receipts, and Issue System. AR 725-50

e. Logistics.

Malfunctions Involving Ammunition and Explosives AR 700-1300-8

f. Maintenance of Supplies and Equipment.

Organization Policies and Responsibilities for
Maintenance Operations. AR 750-5

g. Packaging and Preservation.

General Packaging Instructions for Ordnance General Supplies TM 9-200

Preservation, Packaging, and Packing of Military
Supplies and Equipment. TM 38-230

Preservation, Methods of MIL-P-116C

h. Safety.

Accident Reporting and Records AR 385-40

INDEX

	Paragraphs	Page		Paragraphs	Page
Assembly of barrel and slide group -----	33	28	Inspection, scope of -----	11	12
Assembly of receiver group -----	38	37	Installation of cartridge magazine -----	28	21
Barrel and slide group, assembly (See Assembly of barrel and slide group)			Lubrication -----	23	19
Barrel and slide group, cleaning -----	30	22	Maintenance allocation, direct and general support -----	2	2
Barrel and slide group, disassembly -----	29	22	Maintenance, general (See General maintenance)		
Barrel and slide group, inspection -----	31	22	Maintenance parts -----	7	7
Barrel and slide group, repair -----	32	26	Manual, scope of -----	,	2
Burs, screwheads and working surfaces. removal of -----	22	19	Marking instructions -----	42	41
Cartridge magazine, cleaning -----	26	21	Materiel in the hands of troops, inspection of -----	15	13
Cartridge magazine, disassembly -----	25	21	Ordnance shop inspections -----	16	15
Cartridge magazine, inspection -----	27	21	Parts, maintenance -----	7	7
Cartridge magazine, installation -----	28	21	Precautions in cleaning, general -----	20	19
Cartridge magazine, removal -----	24	21	Preparation and shipping instructions:		
Categories of inspection -----	13	13	Marking instructions -----	42	41
Cleaning -----	19	18	Preparation -----	41	41
Cleaning of barrel and slide group -----	30	22	Shipping instructions -----	43	41
Cleaning of cartridge magazine (See Cartridge magazine, cleaning)			Preparation instructions, shipping -----	41	41
Cleaning of receiver group -----	35	28	Purpose of inspection -----	12	12
Common tools and equipment -----	8	7	Receiver group, assembly -----	38	37
Data, tabulated (See Tabulated data)			Receiver group, cleaning -----	35	28
Description -----	4	3	Receiver group, disassembly -----	34	28
Direct and general support maintenance allocation -----	2	2	Receiver group, inspection of -----	36	28
Disassembly of barrel and slide group -----	29	22	Receiver group, repair -----	37	28
Disassembly of cartridge magazine -----	25	21	Records and reports, forms -----	3	2
Disassembly of receiver group -----	34	28	Removal of burs, screwheads and working surfaces -----	22	19
Final inspection, general (See General, final inspection)			Removal of cartridge magazine -----	24	21
Finished surfaces -----	21	19	Repair methods, general (See General repair methods)		
Forms, records, and reports -----	3	2	Repair of barrel and slide group -----	32	26
General, final inspection -----	39	38	Repair of receiver group -----	37	28
General, inspecting procedures -----	14	13	Scope of inspection -----	11	12
General, tools and equipment -----	6	7	Scope of manual -----	1	2
General maintenance -----	17	18	Shipping instructions -----	43	41
General precautions in cleaning -----	20	19	Special tools and equipment -----	9	7
General repair methods -----	18	18	Specific inspection procedures -----	40	38
Improvised tools -----	10	7	Surfaces, finished (See Finished surfaces)		
Inspection, categories of -----	13	12	Tables:		
Inspection of barrel and slide group -----	31	22	Improvised tools (table 2) -----	10	7
Inspection of cartridge magazine -----	27	21	Special tools and equipment (table 1) -----	9	7
Inspection of materiel in the hands of troops -----	15	13	Troubleshooting (table 3) -----	16	15
Inspection of receiver group -----	36	28	Tabulated data -----	5	3
Inspections, Ordnance shop (See Ordnance shop inspections)			Tools and equipment, common (See Common tools and equipment)		
Inspection procedures, general (See General inspection procedures)			Tools and equipment, general (See General tools and equipment)		
Inspection procedures, specific (See Specific inspection procedures)			Tools and equipment, special (See Special tools and equipment)		
Inspection, purpose of -----	12	12	Tools, improvised -----	10	7

By Order of Secretary of the Army:

EARLE G. WHEELER,
General, United States Army.
Chief of Staff.

Official:

J. C. LAMBERT,
Major General, United States Army,
The Adjutant General.

Distribution:

Active Army:

USASA (2)
DCSLOG (1)
CNGB (1)
C/COMMEL (1)
USA Ord CD **Agcy** (2)
CofEngrs (1)
TSG (1)
USCONARC (3)
ARADCOM (2)
ARADCOM Rgn (2)
OS **Maj** Comd (2) except
 USAREUR (3)
 USARJ (3)
USAMC (5)
USAWECOM (60)
USAMICOM (2)
USAMUCOM (2)
USAECOM (2)
USAMOCOM (2)
USASMCOM (1)
USATECOM (2)
USAATBD (3)
USAOCDA (2)
OS Base Comd (2)
MDW (2)
LOGCOMD (2)

Armies (3) except
 Sixth (1)
Corps (2)
USA Corps (2)
Div (2)
Bde (2)
Regt/Gp/BG (2)
Bn (2)
Co/Btry (1) except
 Ord Co (2)
Br **Svc** Sch (2) **except**
 Ord Sch (50)
GENDEP (OS) (1)
Ord Sec, GENDEP (OS) (1)
Army Dep (2) except
 Lexington (3)
 Tooele (12)
 Letterkenny (10)
Ord Dep (OS) (2)
USA Tml (1)
POE (1)
USAOSA
Ord **PG** (10)
Arsenals (5)
Springfield **Armory** (5)
Proc Dist (2)

NG: State AG (3); Units - same as Active Army except allowance is one copy **to** each unit.

USAR: Same as Active Army except allowance is one copy **to** each unit.

For explanation of abbreviations used. see AR 320-50.

TM 9-1005-211-34 PISTOL, CAL \approx ER .45, AUTOMATIC, M1911A1